



Floors, Walls & Finishes Solutions
2026 Collection

Gerflor®

Formats

With foam backing (Comfort)



Without foam backing (Compact)

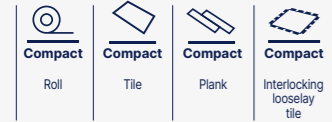

Performances

17 dB

Sound insulation in dB
(EN ISO 717-2)

R10

Slip resistance wet
(DIN 51130)

10⁵

Electrical resistance in Ω:
5 × 10⁴ ≤ R ≤ 10⁶
(EN 1081/DIN 51953)

10⁷

Electrical resistance in Ω:
10⁶ ≤ R ≤ 10⁸
(EN 1081/DIN 51953)



Very high density foam



100% recyclable

Treatments

evercare™

Micro structured cross coat
Polymerised laser technology

PROTECSOL²

Polyurethane surface
Treatment UV cured
Stain shield
Matt effect

**Protecsol®
Protecsol® Mat**

Polyurethane surface
Treatment UV cured

**ProtecShield™
Pur+ Matt**

Polyurethane
surface treatment
Matt surface

Pur+

Polyurethane surface
treatment

Pur

Polyurethane surface
treatment

Sparclean®

Powder coated
treatment

neocare™

New exclusive
Linoleum surface protection

Certification



Scale reduction for Wood designs.
The images of floorcoverings in this catalogue have been reproduced as faithfully as printing technology permits.

Creation 40/55
Tamo Clear

8-23. Premium

Poesy
Neopolis
Metallica
Osmoz
Indiana
Brazilia
Neoterra
Cocoon
Premium ZERO

24-51. Mipolam Homogeneous

Evercare™
Mipolam Symbioz™
Mipolam Planet & Bioplanet
Mipolam Affinity
Mipolam Accord
Mipolam Troplan

Easycare
Mipolam Astro **New**

PUR
Mipolam Classic

52-103. Taralay Multilayered

Taralay Millenium

Taralay Libertex **New**

Taralay Impression
Taralay Impression **hop**

My Taralay Impression

Taralay Initial **New**

104-183. Creation Tiles & Planks

Creation 30/40/55/70 Dry Back **New**

Creation 40/55/70 Clic **New**
Creation 40/55 Clic Acoustic **New**

Creation 55 Looselay / Looselay
Acoustic
Creation 70 Looselay
Creation Saga²

Creation 70 Connect
Creation 70 Megaclac **New**

Creation 40/55/70 Zen

My Creation
My Creation Zen
My Saga

184-195. Carpet Tiles

Armonia 400

Armonia 540 **New** /620

196-211. Wall Solutions

Wall panels & tiles

Mural Revela **New**
Mural Revela accessories **New**

Wall coverings
Mural Ultra Design
Mural Club
Mural Calypso

212-233. Fast Track High Traffic Tiles

GTI° Max

GTI° Pure

GTI° EL5

Attraction®

Design tile

R-tile

234-253. Technical solutions

**EL5 / EL7 solutions
(Dissipative & conductive floors)**

Mipolam EL7
Mipolam Robust EL7
Mipolam EL5
Mipolam Technic EL5
GTI° EL5

Safety flooring

Tarasafe Ultra
Tarasafe Standard
Tarasafe Plus/Super
Tarasafe H₂O
Tarasafe Ultra H₂O

Shower System

Tarasafe Ultra H₂O
Tarasafe Design
Mural Calypso

254-283. DLW Linoleum

Compact Linoleum

Marmorette
Colorette
Uni Walton
Lino Art Urban
Lino Art Moon **New**

Acoustic Linoleum

Marmorette Acoustic
Marmorette Acoustic Plus
Colorette Acoustic Plus
Uni Walton Acoustic Plus

Technical Solutions

High mechanical Traffic Linodur
Dissipative Linoleum Marmorette LCH

284-329. Sport flooring

Taraflex®

Synthetic Sport Flooring

Connor Sports® Aspire | **New**

Engineered wood Flooring Systems

Sport Court®

Outdoor Surfaces

DLW

Linoleum Sport Flooring

Powershock

Fitness Rubber Solutions

330-363. Finishes

Finishes

Skirting solutions
Stair solutions
Profile solutions
Welding solutions
Entrance mats solutions

Installation solutions

Shower system
Accessibility
Acoustic underlayers
Specific products
Adhesives and tapes

Sport finishes

Paint and marking for boundary lines

364-371. Specifications

Gerflor, a world of added value solutions

Gerflor solutions are part of our everyday lives - whether at home, in sports facilities, healthcare centers, schools, workplaces, public spaces, or transportation hubs. Gerflor teams are committed to protecting the health and well-being of people and future generations.

Strong local footprints

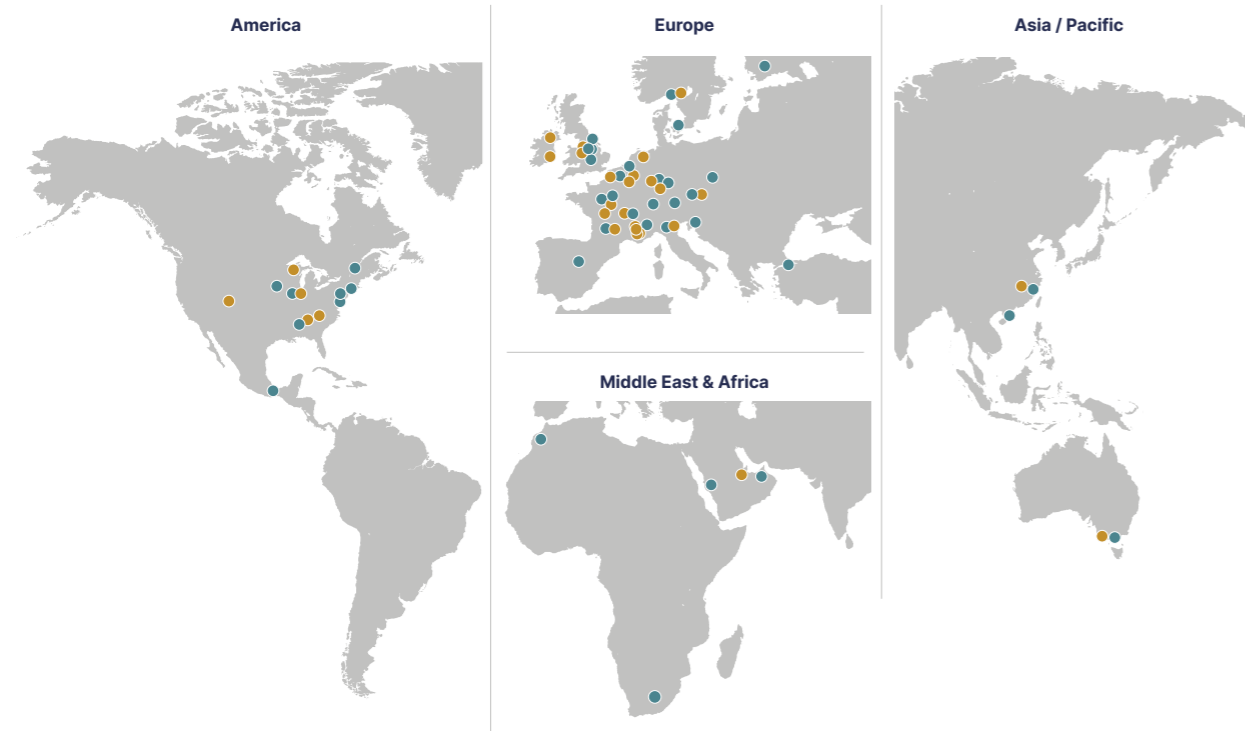

● Sales offices ● Manufacturing Plants (20) & Logistic Hubs (10)

5500 employees **40** sales offices **30** manufacturing plants and logistic hubs **5** technocentres

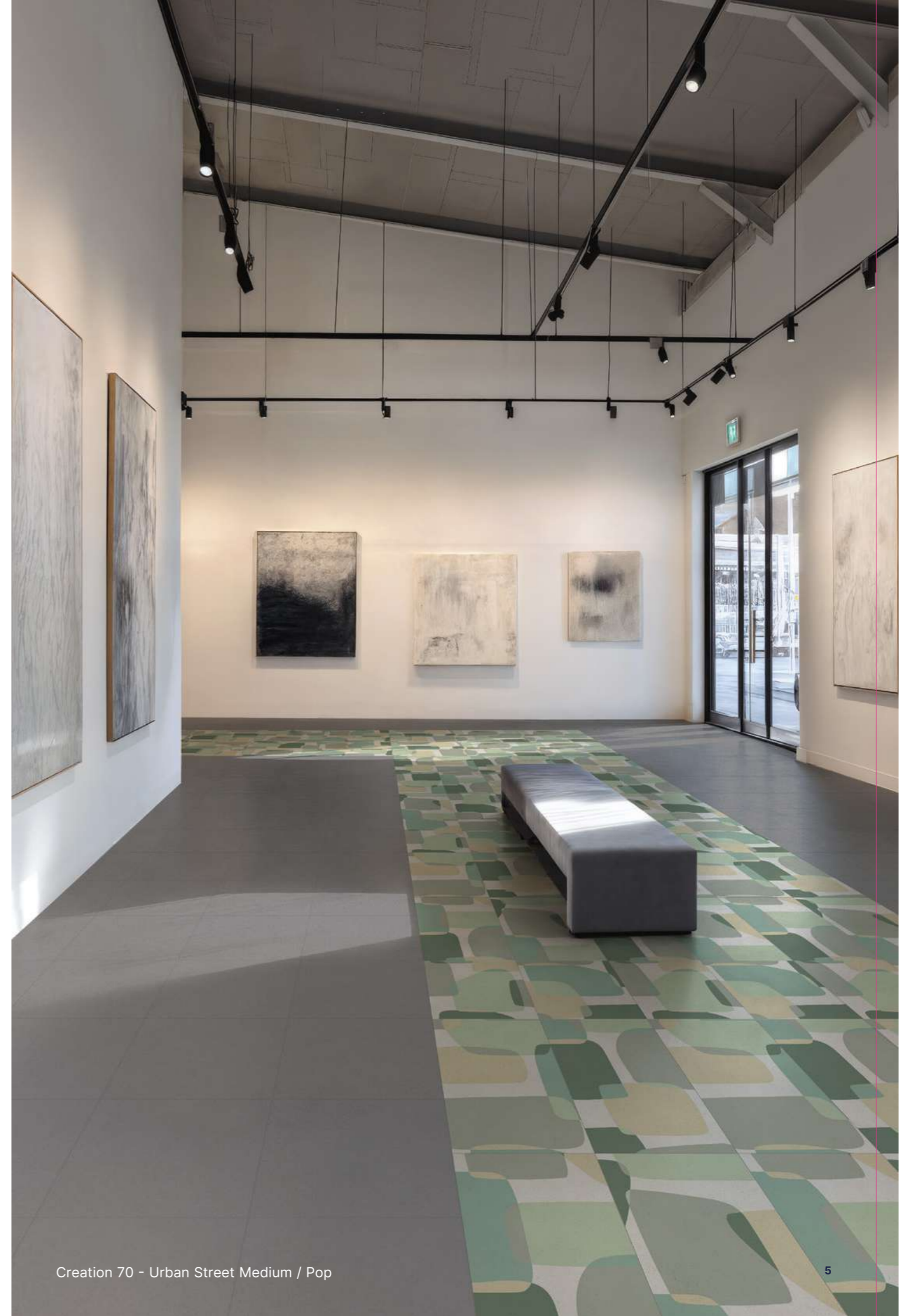

Our commitments for a more sustainable future

2030 Targets



we care for climate

we act with an ambitious decarbonization roadmap

-30% CO₂

scopes 1, 2, 3 in tons eq CO₂, vs 2019. Science Based Targets⁽¹⁾



we care for resources

we act with a more responsible sourcing

75%

biobased, mineral and recycled content⁽²⁾

30%

recycled content⁽³⁾



we care for circularity

we act by closing the loop and reducing waste

65 000 tons

annual volume recycled⁽⁴⁾

45%

looselay⁽⁵⁾



we care for your health and well-being

we act by creating safe and comfortable environments

100%

products better than Indoor Air Quality standards⁽⁶⁾

95%

sales covered by EPD⁽⁷⁾



we care for people

we act by offering a safe and inclusive workspace

30%

women⁽⁸⁾

40%

internal mobility⁽⁹⁾

Towards 0

accident⁽¹⁰⁾

More details:

- Scopes 1, 2 & 3, in absolute value, market-based. Trajectory approved by SBTi (Science Based Targets Initiative).
- Origin of raw materials for the entire Floor & Wall portfolio, on average, by weight; including 15% virgin salt, a primary element in vinyl manufacturing. Compared to 71% in 2024.
- Average content in the Floor & Wall vinyl portfolio, by weight. Compared to 21% in 2024.
- Recycled in our factories and recycling units. Compared to 59 040 tons in 2024.
- % of Floor activity with non-glued products, easy to remove, easy to re-use. Compared to 40% in 2024.
- 100% of vinyl and linoleum sold to the building market below 100 micrograms /m² (TVOC 28 days).
- % of Floor & Wall activity covered by Environmental Product Declarations (EPD). Compared to 44% in 2024.
- % women in our global workforce and among our managers. Compared to respectively 26% and 27% in 2024.
- % job openings filled with internal hires worldwide. Compared to 25% in 2024.
- Towards 0 accident: Lost time accident per million hours worked: below 3 vs 8,9 in 2024, for Gerflor employees worldwide.

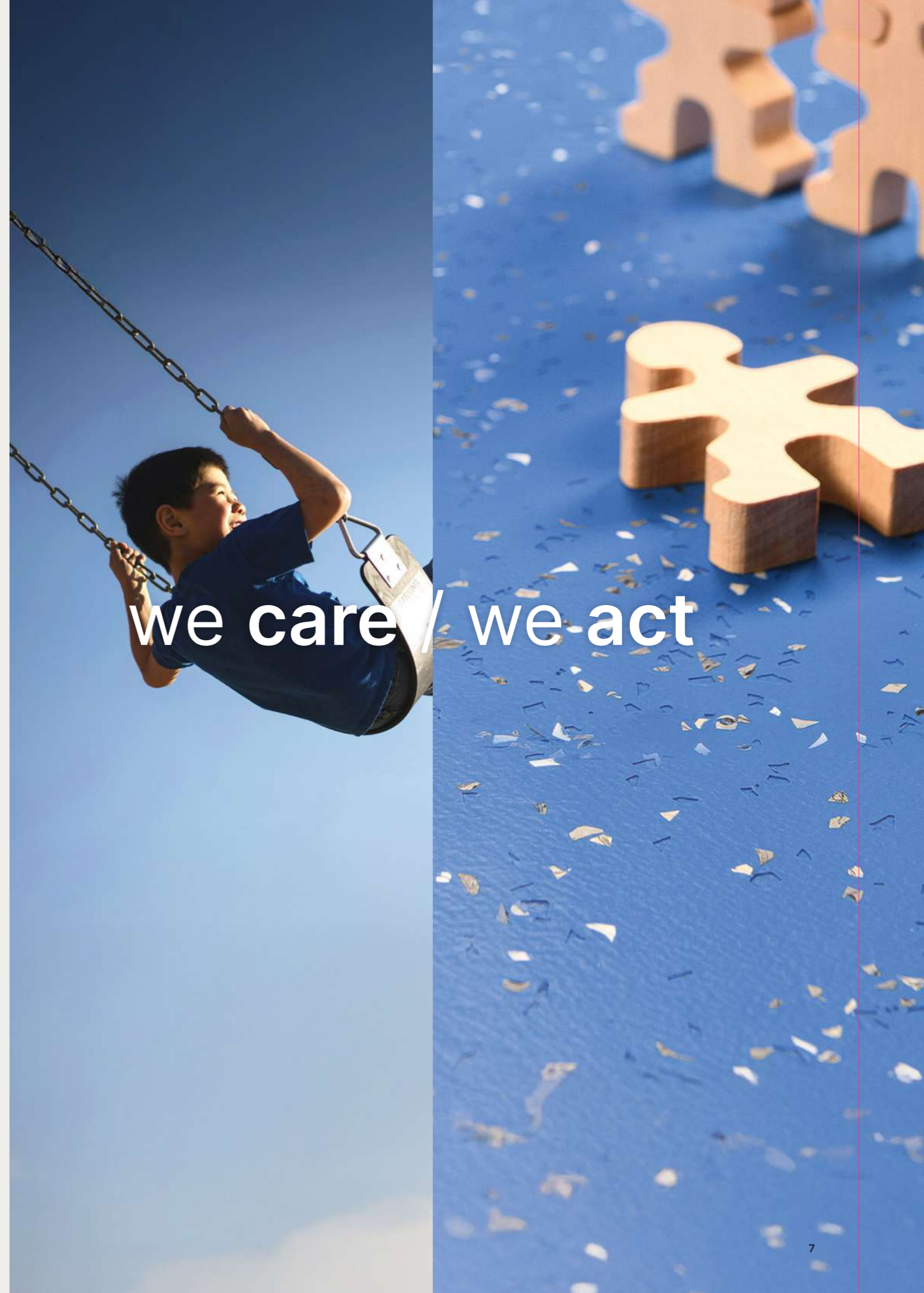

we care / we act



Premium

pages 8-23

nursery

- 8. Premium**
- 14. Poesy
- 15. Neopolis
- 16. Metallica
- 17. Osmoz
- 18. Indiana
- 19. Brazilia
- 20. Cocoon
- 21. Neoterra

- 22. Premium ZERO**

Premium

New collection

More sustainable materials

80%

Biocontent, Mineral & Recycled

Premium contains 20% crop residues from responsible sources. We recycle discarded soy waste from the animal feed industry. The result: less fossil based material and less carbon.

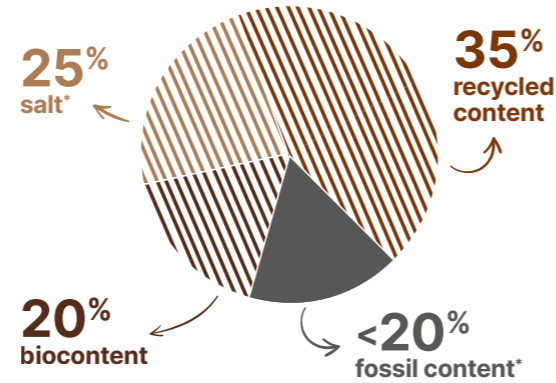

Low carbon solution



Thanks to its improved composition, Premium emits 29%** less CO₂ than the average heterogeneous floorings.

A good choice to decarbonise your projects.

* Vinyl is made of two main ingredients: ethylen and salt.
** Based on life cycle assessment certified by UL for an average heterogeneous product.



To go a step forwards Premium Zero

Towards a world with 0 fossil extraction

More than 95% of natural, recycled and bio-attributed content.
Available on demand and more details on page 54/55.

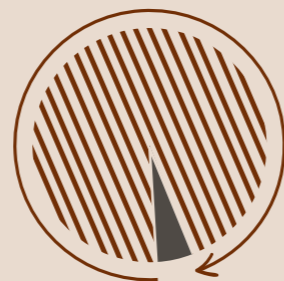

Premium in performances

35 years of satisfied customers



Unrivalled durability

- High density pressed wearlayer
- Pressed under 800 tons
- Immutables designs



High resistance to heavy loads

- Double reinforcement for excellent dimensional stability
- Easy rolling

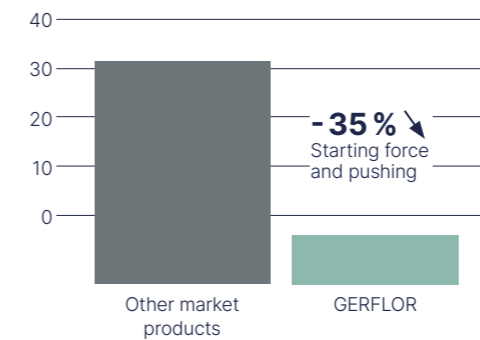

Lower maintenance costs

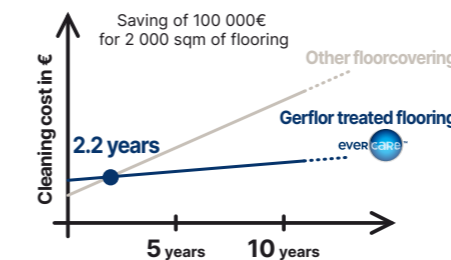

Indoor air quality

- A+ / Floorscore / M1 certified
- Phthalate-free
- Anti-bacterial activity: ISO 22196

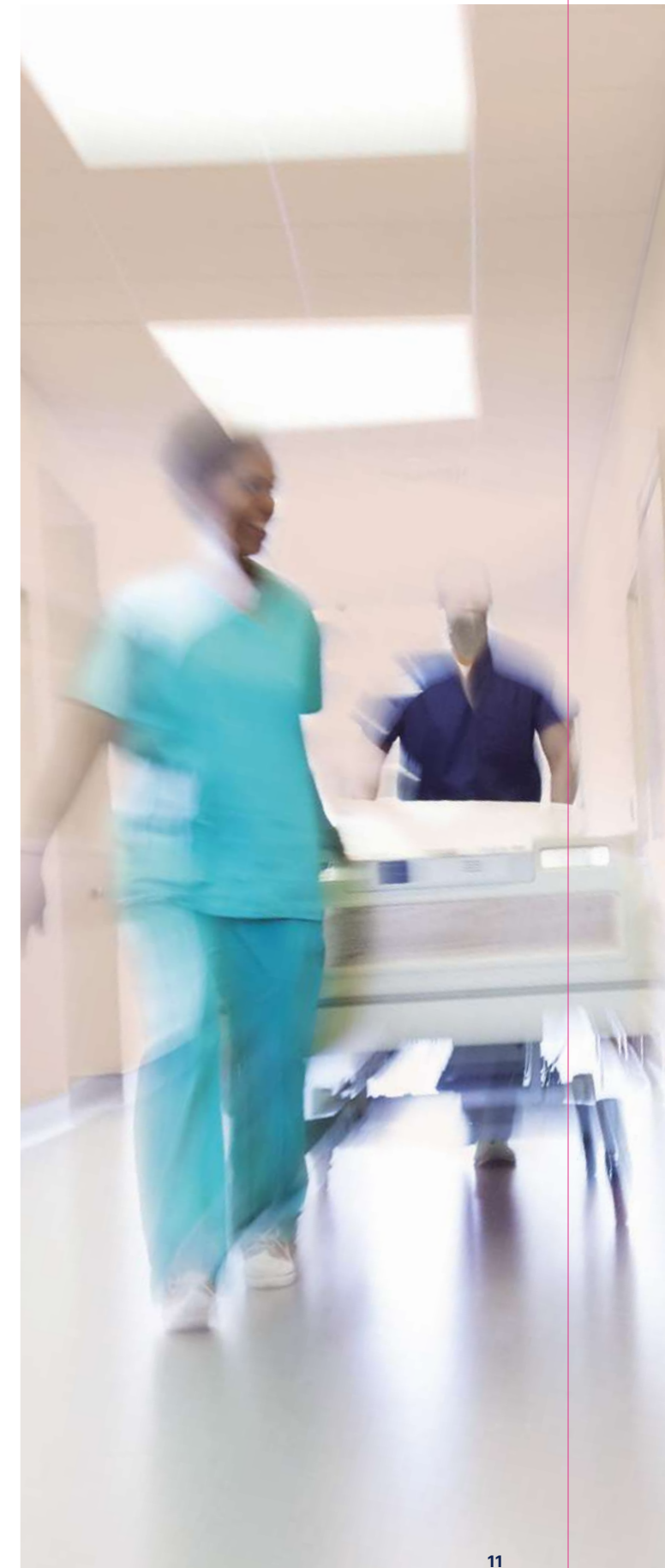

Premium Acoustic

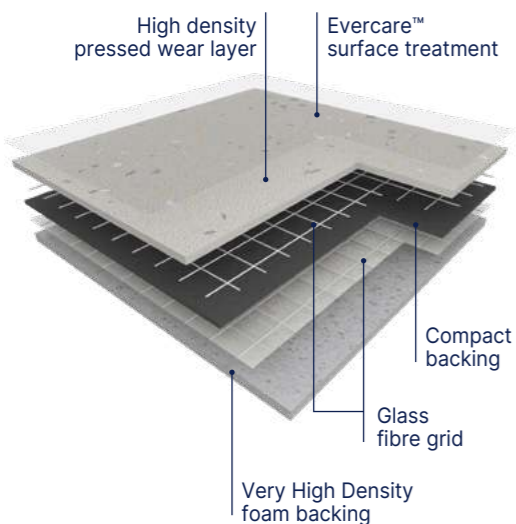

The floor covering is made of a **>1mm thick, pure vinyl homogeneous wear layer with no filler, incorporating very densely pressed coloured chips, with a mat finishing and without a transparent wear layer.**

It offers a T group wear rating and is available in 2 m wide sheet. The product contains a compact backing which is calendared, pressed and a Very High Density (VHD) foam backing. It is reinforced with a double glass fibre grid.

It offers a **16 dB sound insulation, an indentation resistance of 0.06 mm and a rolling heavy loads easiness.**

PREMIUM COMFORT is treated with **Evercare™**, a surface treatment obtained by UV laser crosslinking. It ensures easy maintenance and eliminates permanently the need for acrylic emulsion (metallisation). It avoids staining of chemical products used in healthcare like iodine alcohol, Betadine, eosin and anti-bacterial hand gel.

According to ISO 21702, **PREMIUM COMFORT** has **anti viral activity** against Human Coronaviruses: it reduces the number of virus by 99,7% after 2h00. According to ISO 22196, it has **anti bacterial activity** against E. coli, S. aureus and MRSA of 99% after 24h00.

It is 100% compliant with REACH. It is composed of 40% of minerals and inexhaustible materials. It is made with more than 50% recycled content; 100% of which are fully controlled and REACH compliant. It does not contain any heavy metals, any formaldehydes and it is made with phthalate free plasticizers. The products emission rate of volatile organic compounds is **<10µg/m³ (TVOC after 28 days – ISO 16000-6)**. It is 100% recyclable.

Premium Compact

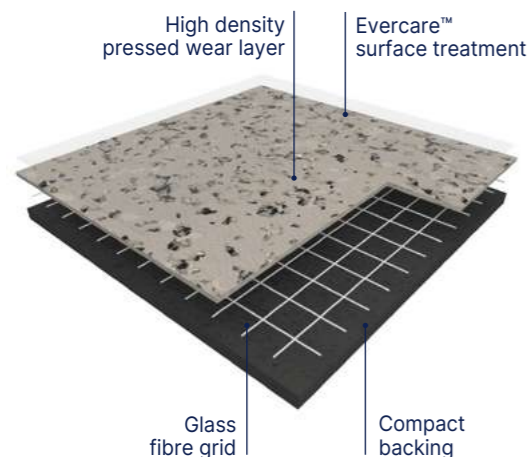

Our **PREMIUM COMPACT** is made of a **>1mm thick, pure inlaid wearlayer pressed under 800 tonnes with no filler, incorporating very densely pressed coloured chips, with a mat finishing and without a transparent wear layer.** It offers a T group wear rating and is available in 2 m wide sheet. Its compact backing is calendared, pressed and reinforced with a fiber grid yielding. It offers a **8 dB sound insulation, an indentation resistance of 0.02 mm and a rolling heavy loads easiness.**

PREMIUM COMPACT is treated with **Evercare™**, patented surface treatment obtained by UV laser cross-linking offering the best chemical resistance to the main products used in healthcare environment as betadine, eosin, hydro alcoholic solutions, making the maintenance easy and the floor long lasting. This treatment avoids applying any acrylic emulsion throughout the lifetime of the product.

According to ISO 21702, **PREMIUM COMPACT** has **anti viral activity** against Human Coronaviruses: it reduces the number of virus by 99,7% after 2h00.

According to ISO 22196, it has **anti bacterial activity** against E. coli, S. aureus and MRSA of 99% after 24h00.

It is composed of: 42% of recycled content / 19% of bio-sourced raw material (from agricultural vegetal waste) / 56% of mineral raw material ; 100% of which are fully controlled and REACH compliant.

It is free of formaldehyde, heavy metals and CMR 1 & 2 or vPvB (very persistent and very bio accumulative) or PBT (persistent, bio-accumulative and toxic) and is 100% REACH compliant. **Its VOC emissions after 28 days (ISO 16000-6) are below detection levels (<10 µg / m³) and this product is classified A + (the best class) and Floorscore® & M1 certified for indoor air quality.** **PREMIUM COMPACT** has antibacterial efficacy (E.coli / S.aureus / MRSA): >99% after 24 hours according to ISO22196.

PREMIUM COMPACT is made in France, is 100% recyclable, and the floorcovering will have its individual EPD sheet (number 4790130460.106.2).



• Outstanding durability

Design within the whole thickness of the wear layer, ≥ 1.02 mm thick

• Long lasting appearance

Pure vinyl wear layer (no filler, no transparent wear layer) for the best scratch and soiling resistance

• Easy maintenance & matt effect

Evercare™ surface treatment

• Excellent indoor air quality

TVOC after 28 days < 10 microgram/m³

• Rolling heavy loads easiness, best stability and very high performance indentation / acoustic 0.06 mm / 17 dB (Metallica: 16 dB) for Comfort, 0.02 mm / 8 db for Compact Glass fibre grid reinforcement & very high density foam backing

Description	Premium Acoustic		Premium Compact	
	Brazilia / Indiana / Cocoon / Neopolis / Osmoz / Poesy / Neoterra - Metallica		Brazilia / Indiana / Cocoon / Neopolis / Osmoz / Poesy / Neoterra - Metallica	
Total thickness	EN ISO 24346	mm	3.00 - 3.30	2.00
Thickness of wearlayer	EN ISO 24340	mm	≥ 1.02	≥ 1.02
Weight	EN ISO 23997	g/sqm	≥ 2800	2580 - 2620
Width of sheet	EN ISO 24341	cm	200	200
Length of sheet	EN ISO 24341	lm	25	20
Phthalate free	-	-	OK	OK
Classification				
Norm / Product specification	-	-	EN ISO 11638	EN ISO 10582
European classification	EN ISO 10874	class	34-42	34-43
Fire rating	EN 13501-1	class	Cfl-s1	Bfl-s1
Static electrical propensity	EN 1815	kV	< 2	< 2
Slip resistance	EN 16165:2021 – Appendix B (DIN 51 130)	class	R10	R10
Performances				
Wear resistance	EN 660.2	mm³	≤ 2.0	≤ 2.0
Wear group	-	group	T	T
Type Binder content	EN ISO 10582	type	-	I
Dimensional stability	EN ISO 23999	%	≤ 0.40	≤ 0.40
Residual indentation (requirement)	EN ISO 24343-1	mm	≤ 0.20	≤ 0.10
Residual indentation (average measured value)	-	mm	≈ 0.06	≈ 0.02
Impact sound insulation	EN ISO 717-2	dB	17 16 (Metallica)	8
Castor chair test (type H)	ISO 4918	-	OK	OK
Thermal conductivity	EN ISO 10456	W/(m.k)	0.25	0.25
Colour fastness	EN ISO 105-B02	degree	≥ 6	≥ 6
Surface treatment	-	-	Evercare™	Evercare™
Chemical products resistance ⁽¹⁾	EN ISO 26987	-	OK	OK
Environment				
Recycled content (average)	-	%	25	43
Recyclability	-	%	100	100
EPD	-	-	Available	Available
Health				
Anti-bacterial activity (E. coli - S. aureus - MRSA) after 24h ⁽²⁾	ISO 22196	-	> 99% inhibits growth	> 99% inhibits growth
Anti-viral activity (human coronavirus) after 2h ⁽²⁾	ISO 21702	-	> 99.7% virucidal activity	> 99.7% virucidal activity
TVOC after 28 days	ISO 16000-6	microgram/m³	< 10	< 10
Certification	-	-	Floorscore®	Floorscore®
CE marking				



(1) Regarding the resistance to chemicals, please download the corresponding leaflet from our website.
 (2) The implementation of an effective cleaning regime is the most important defence against infection.



Premium

Poesy

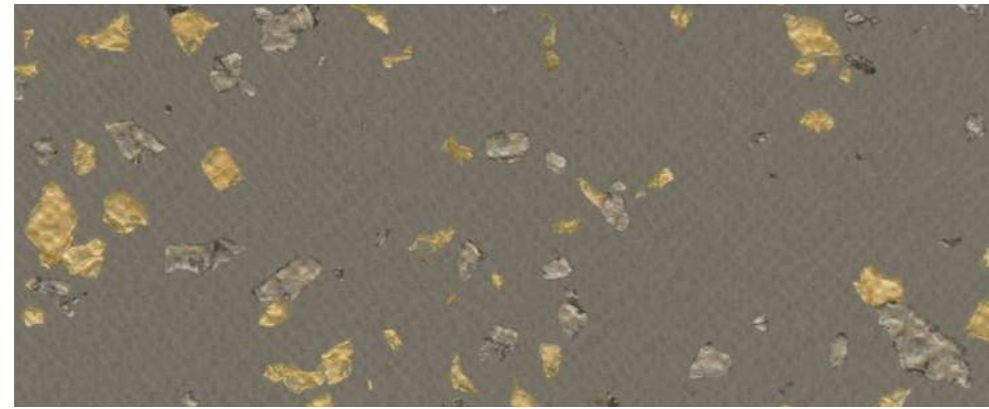

 17 dB
 
 Evercare™
 
 100% recyclable



2749 Lyrique

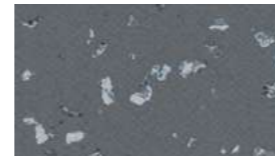

^ Scale 1



2752 Litote

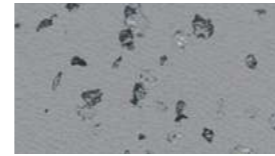



2751 Slam



POESY 2749 Lyrique / METALLICA 8257 Nyx



2748 Refrain

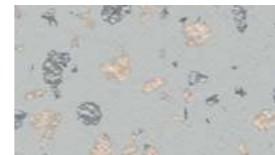



2750 Ellipse

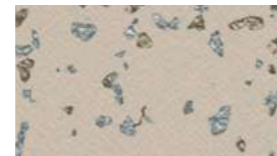



2747 Ballade





8621 Ode





2151 Sonate





8627 Allegorie





2152 Octave





2501 Rhapsody





8626 Rime



Neopolis



 17 dB
 
 Evercare™
 
 100% recyclable



2743 Central Park

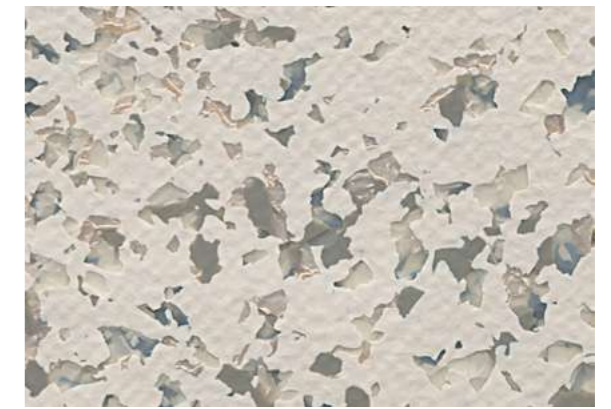

2743 Central Park



^ Scale 1



2744 Queens Soft

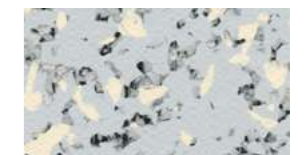

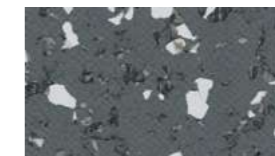

2745 Plaza





2741 Brooklyn



2740 Harlem Soft



2742 Times Square

Premium

Metallica

Compact Acoustic 16 dB VHD Evercare™ 100% recyclable



0062 Beyla



0062 Beyla ^ Scale 1



0061 Eldir



0060 Dellig



9753 Energy

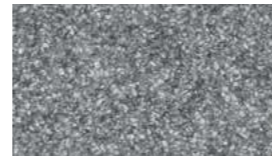

9745 Cosmic

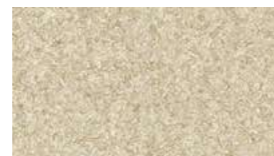

0064 Sudri

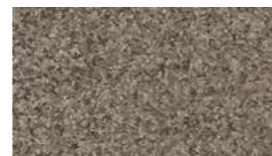

0063 Narfi



8257 Nyx

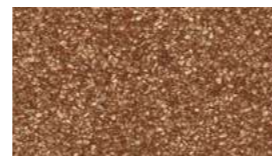

2746 Ymir

Osmoz

Compact Acoustic 17 dB VHD Evercare™ 100% recyclable



4364 Ivory / 4379 Koudou

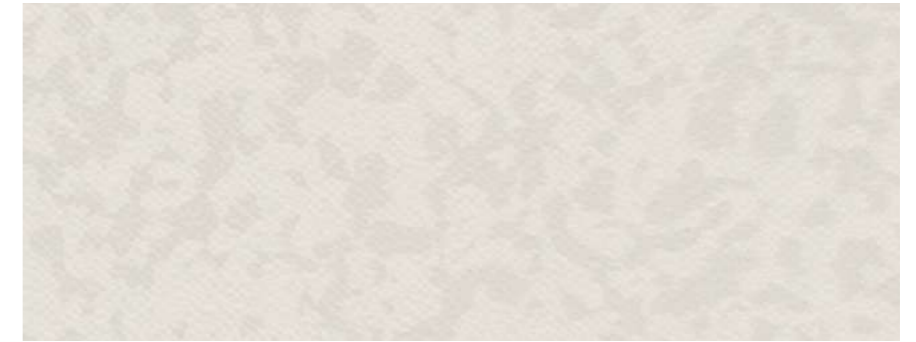

4364 Ivory ^ Scale 1

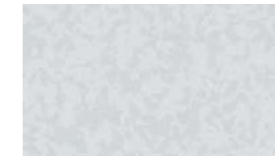

4378 Igloo

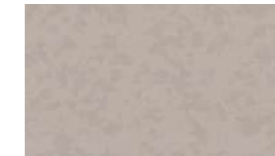

4349 Angora

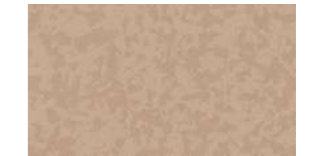

4379 Koudou

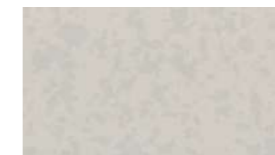

4365 Alpaga



4380 Awara



4384 Barbadine

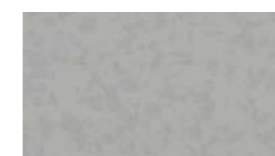

3792 Storm Grey



4381 Rozelle



4383 Jasmin



3791 Slate Grey



4351 Greige



4382 Cyclades

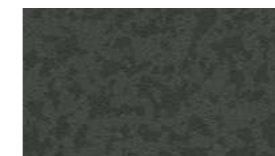

7737 Pepper Grey

Premium

Indiana



 17 dB
 
 Evercare™
 
 100% recyclable

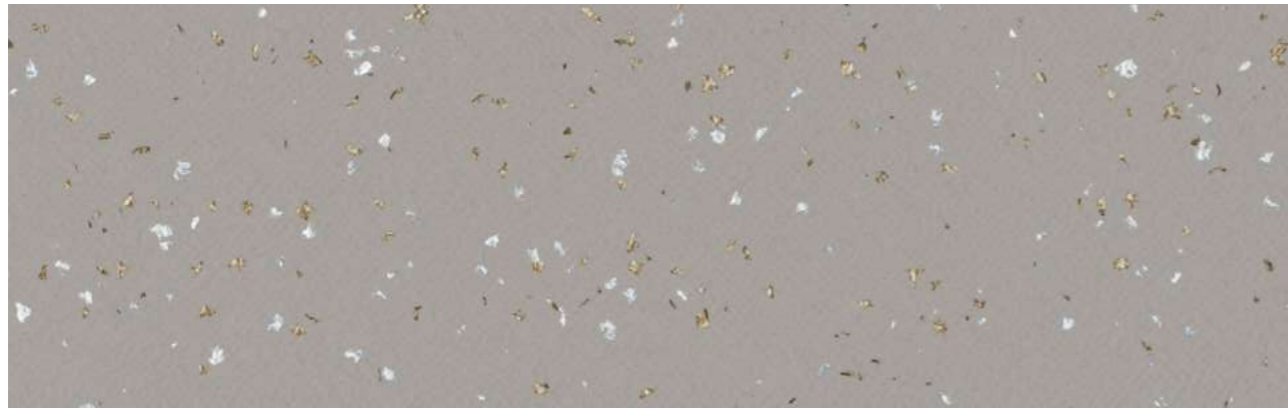

8226 Fidji ^ Scale 1





8150 Bali





4048 Malabo



4045 Dalupiri





4001 Ofu



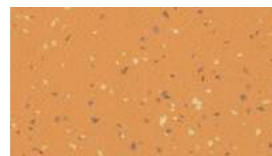

4343 Tokelau







4049 Kilmia





7517 Faroe



4009 Tufoa







4052 Calero







4050 Comores



4047 Okuza





4002 Manua





4053 Diwaran





4051 Maraca





4476 Wattaru



4046 Cubagua



8837 Songo



4003 Tao

Brazilia



 17 dB
 
 Evercare™
 
 100% recyclable

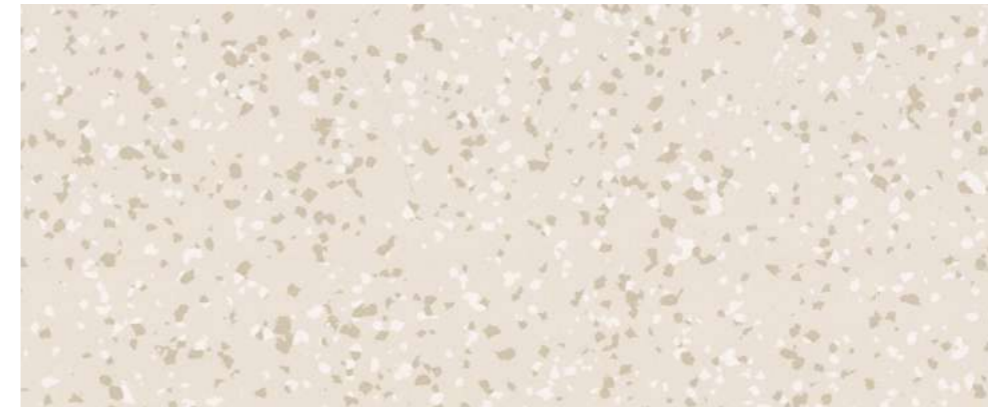

8386 Boa Vista ^ Scale 1



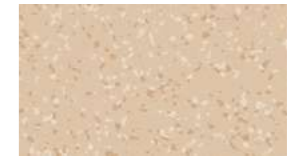

0051 Alvorada





0053 Limeira





0058 Aracaju / 8386 Boa Vista / 0054 Barueri



0056 Natal

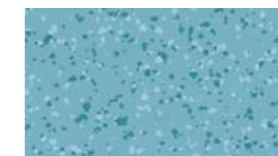

0052 Olinda

4477 Maceio



0054 Barueri



0058 Aracaju





0055 Teresina



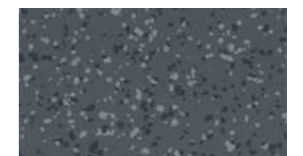

8736 Recife



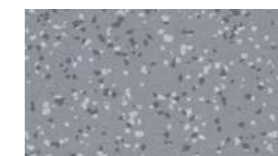

3707 Paraiba

3709 Ceara

Premium

Cocoon

Compact Acoustic 17 dB VHD Evercare™ 100% recyclable



0032 Satin / 0030 Crinolin /
0027 Muslin / 0028 Organza

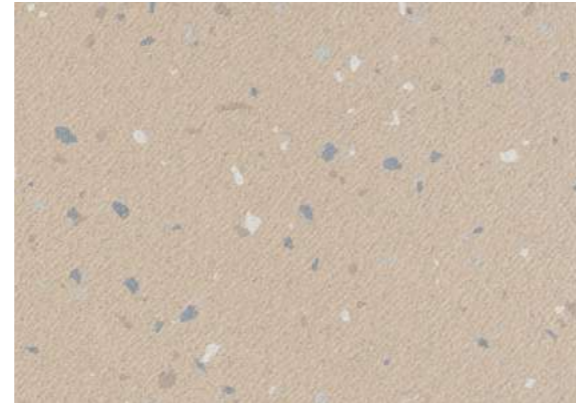

0032 Satin ^ Scale 1



0030 Crinolin



0027 Muslin



0029 Flannel



0028 Organza

Neoterra

Compact Acoustic 17 dB VHD Evercare™ 100% recyclable



NEOTERRA 4208 Dorata / INDIANA 4052 Calero



4208 Dorata ^ Scale 1



4207 Prato



4208 Soraya



4206 Lazuli

Premium ZERO

Facing the urgent challenges of climate change and resource scarcity, we are committed to reducing the environmental impact of our products.

Together, let's build a more sustainable future, one step at a time.

we care / we act

Towards ZERO carbon

The innovative Premium ZERO formula further strengthens our commitment to reducing carbon footprints and supports your projects where very low carbon materials are required.

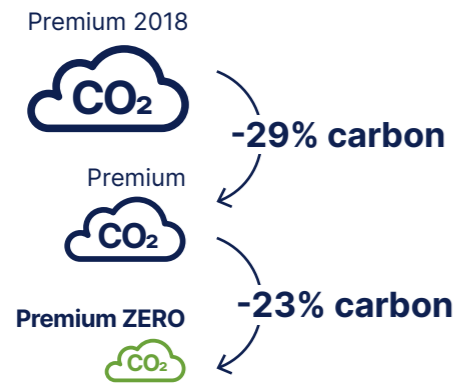

Thanks to its pioneering composition, Premium ZERO Compact carbon footprint is only 4kg eq CO₂/sqm (based on 1 year life cycle) and 7kg eq CO₂/sqm (based on 25 years life cycle)



EPD available certified by UL.

Product available on demand.

For more information, please contact your Gerflor representative

Towards ZERO fossil extraction

Premium ZERO is a new generation of flooring that's leading the way towards using zero virgin ingredients and achieving zero fossil extraction.

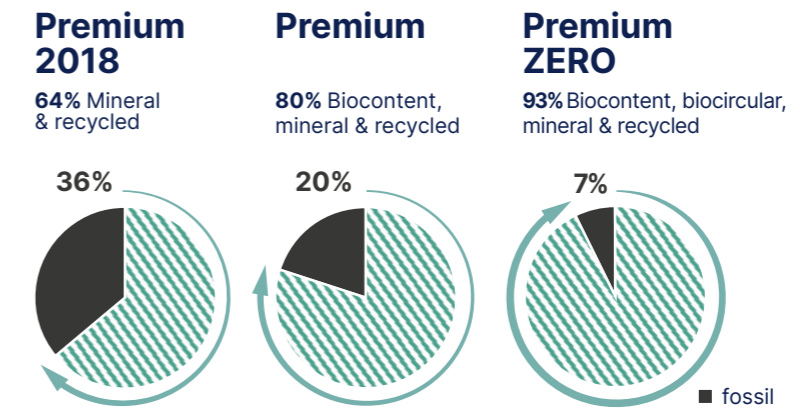

Inside Premium ZERO: one step further



Biocontent

Ingredients made from soy residues, turning agricultural waste into a valuable resource that ensures product flexibility.



Biocircular

Vinyl made from renewable sources like used cooking oil, reducing reliance on fossil fuels while maintaining quality. Third-party certified (ISCC Plus) according to a mass balance approach.

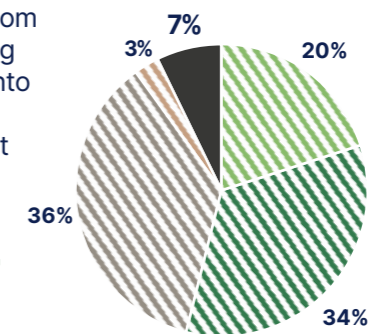

■ biocontent ■ biocircular ■ recycled ■ mineral



Mipolam Homogeneous

pages 24-51

**28. Mipolam Homogeneous
Evercare™**

- 30. Mipolam Symbioz™
- 34. Mipolam Planet & Bioplanet
- 38. Mipolam Affinity
- 42. Mipolam Accord
- 44. Mipolam Troplan

**46. Mipolam Homogeneous
Easycare**

- 48. Mipolam Astro **New**

**50. Mipolam Homogeneous
PUR**

- 50. Mipolam Classic

Mipolam Homogeneous

Type Binder content EN ISO 10581

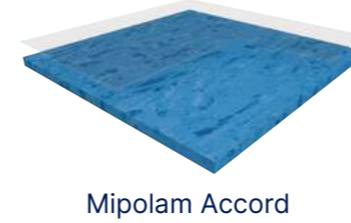
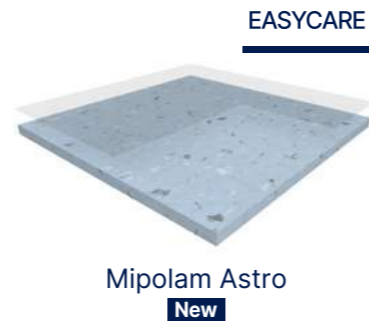

Bio Content
17 %



Bio Content
17 %

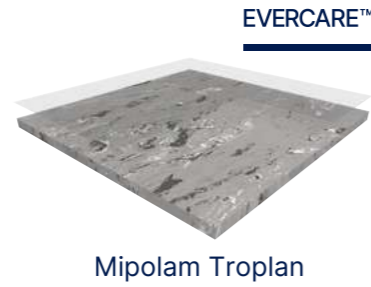
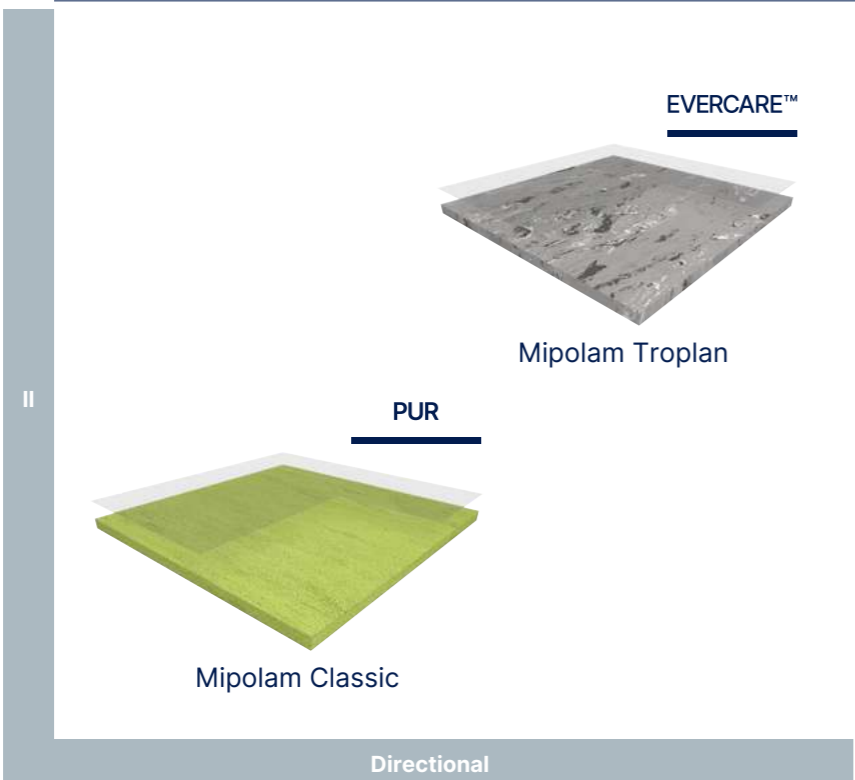

Directional

Non directional



Maintenance

Mipolam
Homogeneous

Mipolam Homogeneous Evercare™

Mipolam Symbioz™

Mipolam Symbioz™

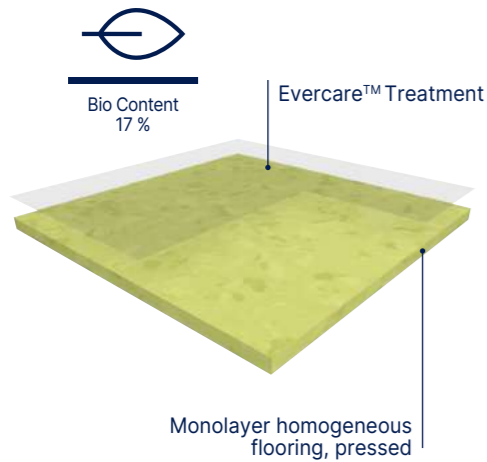

MIPOLAM SYMBIOZ™ is fully flexible homogeneous compacted floorcovering in sheet, 2m wide, providing excellent resistance to wear and tear in high traffic areas. Their weight is **2595 gr/m²**. They feature a non-directional design incorporating coloured chips to ensure an even colour throughout the thickness presenting a **nice matt finish**.

Comprising 83% natural and recycled content, including 17% bio content, 45% mineral raw material (Salt & chalk) and 21% recycled content, **MIPOLAM SYMBIOZ™** achieves a 20% to 30% reduction in Cradle to Gate CO2 emissions compared to standard homogeneous flooring. It is 100% phthalates free and recyclable. This floorcovering is a non-emissive product (below the level of VOC measurement accuracy).

According to ISO 21702, **MIPOLAM SYMBIOZ™** has **anti viral activity** against Human Coronaviruses: it reduces the number of virus by 99,7% after 2h00.

According to ISO 22196, **MIPOLAM SYMBIOZ™** has **anti bacterial activity** against E. coli, S. aureus and MRSA of 99% after 24h00. The flooring is equipped with **Evercare™**, patented surface treatment obtained by **UV laser cross-linking** offering the **best chemical resistance to the main products used in healthcare** environment as Betadine, eosin, hydro alcoholic solutions, making the maintenance easy and long lasting the flooring.

This treatment **avoids applying any acrylic emulsion** throughout the lifetime of the product.

The flooring is **antistatic** (<2kV), its residual indentation is ≈ 0.02 mm. The flooring complies with the EN ISO 10581 norm, has a binder content Type I and is suitable for heavy duty traffic areas and **Bfl-s1 fire** resistance.

As part of our sustainable development policy, this product is manufactured in the first floor covering plant awarded with the triple certification: ISO 9001 (quality), ISO 14 001 (environment) and OHSaS 18001 (safety).



BBR40:
100% Bio-based plasticizer rod for Mipolam Symbioz™
(see page 347)



Evercare™



100% recyclable



Matt finish

Mipolam Homogeneous

Mipolam Symbioz™ have been engineered using a full life cycle model, to guarantee the lowest environmental impact at every stage of the product life

- ▶ **Highest durability:** product life expectancy > 20 years
- ▶ **Eco-responsible exclusive Bio based plasticizer, 100% made from organic source**
- ▶ **Evercare™:** patented polyurethane surface treatment with unique performance in staining providing chemical resistance
- ▶ **Easy maintenance:** no wax for life
- ▶ **On average 30% savings on maintenance cost**
- ▶ **15% less detergent and water use.**

Indoor Air Quality: very low emitting material (40 times lower than European standards).

Mipolam Symbioz™			
Description			
Total thickness	EN ISO 24346	mm	2
Weight	EN ISO 23997	g/sqm	2595
Width of sheet	EN ISO 24341	cm	200
Length of sheet	EN ISO 24341	lm	20
Phthalate free	-	-	OK
Classification			
Norm / Product specification	-	-	EN ISO 10581
European classification	EN ISO 10874	class	34-43
Fire rating	EN 13501-1	class	Bfl-s1
Static electrical propensity	EN 1815	kV	< 2
Slip resistance	EN 16165:2021 – Appendix B (DIN 51 130)	class	R9
Performances			
Type Binder content	EN ISO 10581	type	I
Dimensional stability	EN ISO 23999	%	≤ 0.40
Impact Sound Insulation	EN ISO 717-2	dB	5
Residual indentation (norm)	EN ISO 24343-1	mm	≤ 0.10
Residual indentation (average measured value)	-	mm	≈ 0.02
Castor chair test (type H)	ISO 4918	-	OK
Thermal conductivity	EN ISO 10456	W/(m.k)	0.25
Colour fastness	EN ISO 105-B02	degree	≥ 6
Surface treatment	-	-	Evercare™
Chemical products resistance	EN ISO 26987	class	OK
Environment			
Recycled content (average)	-	%	25
Recyclability	-	%	100
EPD	-	-	Available
Health			
TVOC after 28 days	ISO 16000-6	microgram/m³	< 10
Certification	-	-	Floorscore®
Anti-bacterial activity (E. coli - S. aureus - MRSA) after 24h ⁽¹⁾	ISO 22196	-	> 99% inhibits growth
Anti-viral activity (human coronavirus) after 2h ⁽¹⁾	ISO 21702	-	> 99.7% virucidal activity

CE Marking



EN 14041



(1) The implementation of an effective cleaning regime is the most important defence against infection.

Mipolam Homogeneous Evercare™

Mipolam Symbioz™



Evercare™



100% recyclable



Bio Content
17%

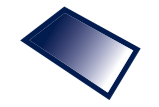

Matt finish

Mipolam
Homogeneous



6027 Acacia



^ Scale 1



6027 Acacia



6002 Lipica



6030 Stonehenge



6001 Cotton

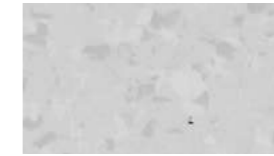

6009 Grey Stone



6050 Hurricane



6056 Tulum

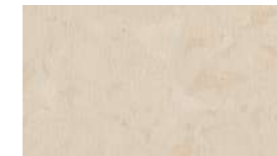

6005 Ghibli



6008 Calico



6036 Oceania



6058 Vermiglio

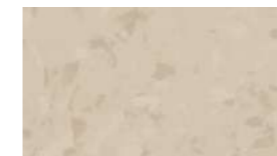

6031 Breeze

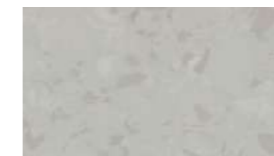

6010 Mist



6037 Lagoon



6018 Ushuaia



6034 Mole

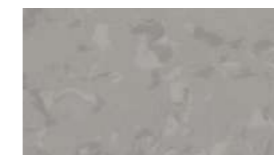

6029 Cloud



6006 Blue Sky



6075 Cardinal

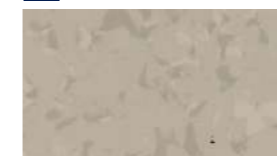

6041 Clay

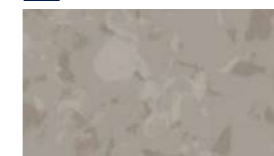

6039 Pebble



6047 Sauge



6065 Segesta



6043 Wood



6044 Sea Storm

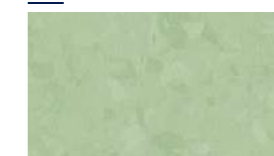

6057 Musk



6025 Tangelo

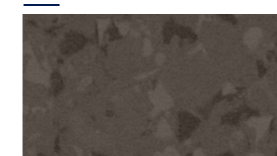

6045 Chocolate



6059 Black Diamond



6067 Kaki



6032 Sunshine



Mipolam Homogeneous Evercare™

Mipolam Planet & Bioplanet

Mipolam Planet & Bioplanet

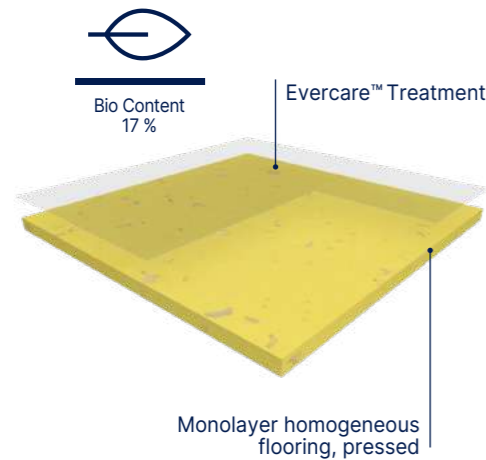

MIPOLAM PLANET is fully flexible homogeneous compacted floorcovering in sheet, 2 m wide, providing excellent resistance to wear and tear in high traffic areas. Their weight is **2700 gr/m²**. They feature a non-directional design incorporating translucent chips that provides a 3D effect and ensures an even colour throughout the thickness presenting a nice matt finish over 40 colours. The flooring is equipped with **Evercare™**, patented surface treatment obtained by UV laser cross-linking offering the best chemical resistance to the main products used in healthcare environment as betadine, eosin, hydro alcoholic solutions, making the maintenance easy and the floor long lasting. This treatment avoids applying any acrylic emulsion throughout the lifetime of the product. It is free of formaldehyde, heavy metals and CMR 1 & 2 or vPvB (very persistent and very bio-accumulative) or PBT (persistent, bio-accumulative and toxic) and is REACH compliant. It is **100% phthalates free and recyclable**. Its VOC emissions after 28 days (ISO 16000-6) are below detection levels (< 10 microgram/m³ and g/m³) and this product is classified A + (the best class). According to ISO 21702, Mipolam Planet has **anti-viral activity** against Human Coronaviruses: it reduces the number of virus by 99.7% after 2h00. According to ISO 22196, Mipolam Planet has **anti-bacterial activity** against E. coli, S. aureus and MRSA of 99% after 24h00. The flooring is **antistatic** (< 2 kV), its residual indentation is ≈ 0.02 mm. The flooring complies with the EN ISO 10581 norm, has a binder content Type I and is suitable for heavy duty traffic areas and **Bfl-s1 fire resistance**. As part of our sustainable development policy, this product is manufactured in the first floor covering plant awarded with the triple certification: ISO 9001 (quality), ISO 14 001 (environment) and OHSaS 18001 (safety).

MIPOLAM BIOPLANET is fully flexible homogeneous compacted floorcovering in sheet, 2 m wide, providing excellent resistance to wear and tear in high traffic areas. Its weight is **2700 gr/m²**. It features a non-directional design incorporating translucent chips that provides a 3D effect and ensures an even colour throughout the thickness presenting a nice matt finish over 40 colours. It contains over 75% sustainable of renewable raw materials. It include a 100% bio based plasticizer, made of residues from non-agricultural food. The flooring is equipped with **Evercare™**, patented surface treatment obtained by UV laser cross-linking offering the best chemical resistance to the main products used in healthcare environment as betadine, eosin, hydro alcoholic solutions, making the maintenance easy and the floor long lasting. This treatment avoids applying any acrylic emulsion throughout the lifetime of the product. It is free of formaldehyde, heavy metals and CMR 1 & 2 or vPvB (very persistent and very bio-accumulative) or PBT (persistent, bio-accumulative and toxic) and is REACH compliant. It is **100% phthalates free and recyclable**. Its VOC emissions after 28 days (ISO 16000-6) are below detection levels (< 10 microgram/m³ and g/m³) and this product is classified A + (the best class). According to ISO 21702, Mipolam Bioplanet has **anti-viral activity** against Human Coronaviruses: it reduces the number of virus by 99.7% after 2h00. According to ISO 22196, Mipolam Bioplanet has **anti-bacterial activity** against E. coli, S. aureus and MRSA of 99% after 24h00. The flooring is **antistatic** (< 2 kV), its residual indentation is ≈ 0.02 mm. The flooring complies with the EN ISO 10581 norm, has a binder content Type I and is suitable for heavy duty traffic areas and **Bfl-s1 fire resistance**. As part of our sustainable development policy, this product is manufactured in the first floor covering plant awarded with the triple certification: ISO 9001 (quality), ISO 14 001 (environment) and OHSaS 18001 (safety).



Evercare™



100% recyclable



Matt finish

- ▶ **Recycled content up to 25%, 100% Recyclable**
- ▶ **Bio content 17% (Mipolam BioPlanet - on demand)**
- ▶ **Anti-viral activity & Anti-bacterial activity**
- ▶ **Indoor air quality: TVOC 100 times below standard**
- ▶ **40 COLOURS: Bright and subtle non directional design**
- ▶ **Heavy traffic resistance**
- ▶ **Ease of maintenance thanks to Evercare™**

			Mipolam Planet	Mipolam BioPlanet	Mipolam Planet R10
Description					
Total thickness	EN ISO 24346	mm	2	2	2
Weight	EN ISO 23997	g/sqm	2700	2700	2700
Width of sheet	EN ISO 24341	cm	200	200	200
Tile size	EN ISO 24342	mm	608 × 608 ⁽¹⁾	608 × 608 ⁽¹⁾	608 × 608 ⁽¹⁾
Length of sheet	EN ISO 24341	lm	20	20	20
Phthalate free	-	-	OK	OK	OK
Classification					
Norm / Product specification	-	-	EN ISO 10581	EN ISO 10581	EN ISO 10581
European classification	EN ISO 10874	class	34-43	34-43	34-43
Fire rating	EN 13501-1	class	Bfl-s1	Bfl-s1	Bfl-s1
Static electrical propensity	EN 1815	kV	< 2	< 2	< 2
Slip resistance	EN 16165:2021 – Appendix B (DIN 51 130)	class	R9	R9	R10
Performances					
Type Binder content	EN ISO 10581	type	I	I	I
Dimensional stability	EN ISO 23999	%	sheet < 0.40	sheet < 0.40	sheet < 0.40
Dimensional stability (average measured value)	-	%	sheet ≈ 0.10	sheet ≈ 0.10	sheet ≈ 0.10
Impact Sound Insulation	EN ISO 717-2	dB	5	5	5
Residual indentation (norm)	EN ISO 24343-1	mm	≤ 0.10	≤ 0.10	≤ 0.10
Residual indentation (average measured value)	-	mm	≈ 0.02	≈ 0.02	≈ 0.02
Castor chair test (type H)	ISO 4918	-	OK	OK	OK
Decontamination	ISO 8690	-	Excellent	Excellent	Excellent
Watertightness	EN 13553	Annex A	Pass	Pass	Pass
Thermal conductivity	EN ISO 10456	W/(m.k)	0.25	0.25	0.25
Colour fastness	EN ISO 105-B02	degree	≥ 7	≥ 7	≥ 7
Surface treatment	-	-	Evercare™	Evercare™	Evercare™
Chemical products resistance	EN ISO 26987	class	OK	OK	OK
Environment					
Recycled content (average)	-	%	25	25	25
Recyclability	-	%	100	100	100
EPD	-	-	Available	Available	Available
Health					
TVOC after 28 days	ISO 16000-6	microgram/m ³	< 10	< 10	< 10
Certification	-	-	Floorscore®	Floorscore®	Floorscore®
Anti-bacterial activity (E. coli - S. aureus - MRSA) after 24h ⁽²⁾	ISO 22196	-	> 99% inhibits growth	> 99% inhibits growth	> 99% inhibits growth
Anti-viral activity (human coronavirus) after 2h ⁽²⁾	ISO 21702	-	> 99.7% virucidal activity	> 99.7% virucidal activity	> 99.7% virucidal activity
CE Marking					



EN 14041



(1) Products available in tiles for a minimum quantity order of 500 sqm.

(2) The implementation of an effective cleaning regime is the most important defence against infection.

Mipolam Homogeneous Evercare™

Mipolam Planet & Bioplanet



Evercare™



100% recyclable

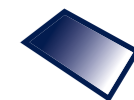

Matt finish

Mipolam
Homogeneous



5404 Vanilla Sky



^ Scale 1



5403 Moon Dust

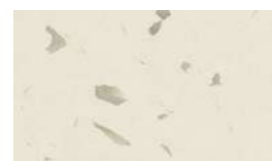

5402 Ivory Dust



5412 Moon Stone

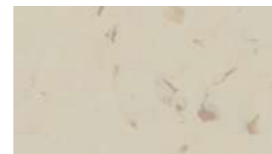

5424 Hawk Eye

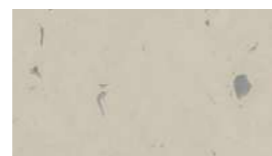

5441 Clay Soil



5432 Sun Stone



5418 Terra Nera



5422 Sunflower



5438 Andalusite



5428 Shedded Ground



5443 Wood Path



5445 Tree Bark



5444 Rocky Hill

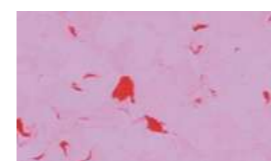

5482 Sugar Drip



5406 Moqui



5430 Sideral Grey



5460 Lava Stone



5437 Reef Water



5416 Acquamarina



5450 Blended Ashes



5459 Stormy Cloud

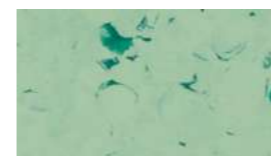

5417 Foggy Hill



5426 Shadow



5420 Stone Powder



5429 Fog Patch



5427 Green Zest



5436 Tiger Eye



5413 Rain Fall



5439 Moon Way



5447 Aventurine



5456 Intense Indigo



5410 Silex



5411 Atlantic Grey



5455 Lava Flow



5466 Rocky Blue



5408 Chalk Dust



5409 Pebble Beach



5475 Intense Ruby



5446 Blue Nug



Mipolam Homogeneous Evercare™

Mipolam Affinity / Accord / Troplan

Mipolam Affinity

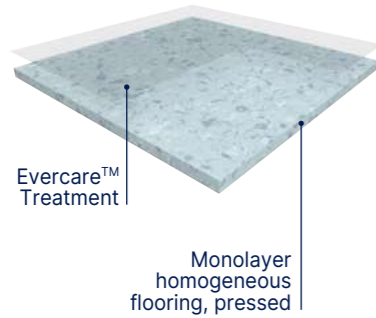

MIPOLAM AFFINITY is a vinyl flooring homogeneous pressed in 2 m sheets, with a thickness of 2 mm and a **weight of 2800 g**. The non-directional design with colour throughout the thickness is available in 50 references presenting a contrasted designed & a **mat finish**. This flooring is recommended for collective buildings making skirtings easier, as well as angles and welding. The flooring is equipped with **Evercare™**, patented surface treatment obtained by **UV laser cross-linking** offering **the best chemical resistance to the main products used in healthcare** environment as Betadine, eosin, hydro alcoholic solutions, making the maintenance easy and the floor long lasting. This treatment **avoids applying any acrylic emulsion** throughout the lifetime of the product. According to ISO 21702, **MIPOLAM AFFINITY** has **anti-viral activity** against Human Coronaviruses: it reduces the number of virus by 99.7% after 2h. According to ISO 22196, **MIPOLAM AFFINITY** has **anti-bacterial activity** against E. coli, S. aureus and MRSA of 99% after 24h. It is free of formaldehyde, heavy metals and CMR 1 & 2 or vPvB (very persistent and very bio-accumulative) or PBT (persistent, bio-accumulative and toxic) and is **REACH compliant**. It is 100% phthalate free and recyclable. Its VOC emissions after 28 days (ISO 16000-6) are below detection levels (<10 microgram/m³) and this product is classified A + (the best class). This flooring is **antistatic** (< 2 kV), its residual indentation is ≤ 0.02 mm to 150 minutes respecting EN ISO 24343-1. This flooring complies with EN ISO 10581 offering a Binder content Type I, which makes it suitable for heavy duty traffic areas. It has a **Bfl-s1 fire** resistance.

Mipolam Accord

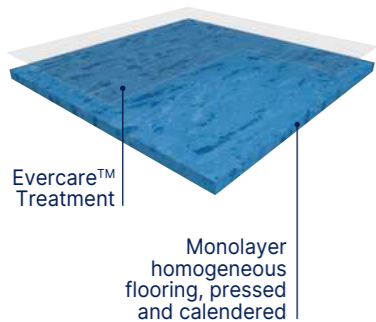

MIPOLAM ACCORD is a vinyl flooring homogeneous calendered and pressed in 2m sheets, with a thickness of 2 mm and a **weight of ≤ 2790 g**. The semi-directional design with colour throughout the thickness is available in 28 references presenting a nice **mat finish**. This flooring is recommended for collective buildings making skirtings easier, as well as angles and welding. The flooring is equipped with **Evercare™** the latest improvements in polyurethane surface treatment obtained by **UV laser cross-linking**. This Evercare™ **avoids staining of chemical products used in Healthcare** like Betadine, eosin or anti-bacterial hand gel and increases the durability of the flooring. This treatment has excellent maintenance characteristics and does not require the application of acrylic polishes. According to ISO 21702, **MIPOLAM ACCORD** has **anti-viral activity** against Human Coronaviruses: it reduces the number of virus by 99.7% after 2h. According to ISO 22196, **MIPOLAM ACCORD** has **anti-bacterial activity** against E. coli, S. aureus and MRSA of 99% after 24h. The flooring is composed of minimum **25% recycled content 100% controlled** and is **REACH compliant**. It is 100% phthalate free and 100% recyclable. This flooring is **antistatic** (<2kV). The product is non-reactive to residual indentation with a value ≤ 0.02 mm to 150 minutes respecting EN ISO 24343-1. The flooring is compliant with EN ISO 10581 norm, has a binder content type I, is suitable for heavy duty traffic areas and has a **Bfl-s1 fire** resistance. The product emission rate of volatile organic compounds is < 10 microgram/m³ (TVOC after 28 days ISO 16000-6).

Mipolam Troplan

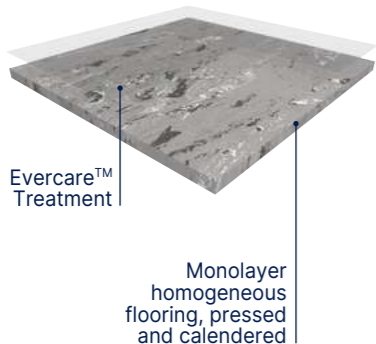

MIPOLAM TROPLAN is a vinyl flooring homogeneous calendered and pressed in 2 m sheets, with a thickness of 2 mm and a **weight ≤ 3300 g**. The directional design with colour throughout the thickness is available in 18 references presenting a nice **mat finish**. This flooring is suitable for medium to high traffic areas, and facilitates floor-wall junctions, angles and welding treatments. The flooring is equipped with **Evercare™**, patented surface treatment obtained by **UV laser cross-linking** offering **the best chemical resistance to the main products used in healthcare** environment as Betadine, eosin, hydro alcoholic solutions, making the maintenance easy and long lasting the flooring. This treatment **avoids applying any acrylic emulsion** throughout the lifetime of the product. According to ISO 21702, **MIPOLAM TROPLAN** has **anti-viral activity** against Human Coronaviruses: it reduces the number of virus by 99.7% after 2h. According to ISO 22196, **MIPOLAM TROPLAN** has **anti-bacterial activity** against E. coli, S. aureus and MRSA of 99% after 24h. It is composed of 45% minerals, 22% of inexhaustible material and at least **25% of recycled 100% controlled**. It is free of formaldehyde, heavy metals and CMR 1 & 2 or vPvB (very persistent and very bio-accumulative) or PBT (persistent, bio-accumulative and toxic) and is **REACH compliant**. **MIPOLAM TROPLAN** is 100% phthalate free and 100% recyclable. VOC emissions after 28 days (ISO 16000-6) are below detection levels with < 10 microgram/m³ and this product is classified A + (the best class). The flooring is **antistatic** (< 2 kV), its residual indentation is ≤ 0.03 mm. The flooring is compliant to the EN ISO 10581 norm, has a binder content type II, is suitable for heavy duty traffic areas and has a **Bfl-s1 fire** resistance.



High performing homogeneous multipurpose floorings

Suitable for heavy traffic areas (education, healthcare, shops)

► **Mipolam Affinity / Mipolam Accord / Mipolam Troplan:**
Evercare™ - New revolutionary patented polyurethane surface treatment with unique performance in staining providing unrivalled chemical and scratching resistance

► **Antistatic**

► **Densely compacted surface for improved wear and ease of maintenance**

			Mipolam Affinity	Mipolam Accord	Mipolam Troplan
Description					
Total thickness	EN ISO 24346	mm	2	2	2
Weight	EN ISO 23997	g/sqm	2800	2790	3300
Width of sheet	EN ISO 24341	cm	200	200	200
Length of sheet	EN ISO 24341	lm	20	20	20
Tile size	EN ISO 24342	mm	608 × 608 ⁽¹⁾	608 × 608 ⁽¹⁾	608 × 608
Number of tiles per package	-	-	20	20	20
Phthalate free	-	-	OK	OK	OK

Classification					
Norm / Product specification	-	-	EN ISO 10581	EN ISO 10581	EN ISO 10581
European classification	EN ISO 10874	class	34-43	34-43	34-43
Fire rating	EN 13501-1	class	Bfl-s1	Bfl-s1	Bfl-s1
Static electrical propensity	EN 1815	kV	< 2	< 2	< 2
Slip resistance	EN 16165:2021 - Appendix B (DIN 51 130)	class	R9	R9	R9

Performances					
Type Binder content	EN ISO 10581	type	I	I	II
Dimensional stability (requirement)	EN ISO 23999	%	Sheet ≤ 0.40 Tile ≤ 0.25	Sheet ≤ 0.40 Tile ≤ 0.25	Sheet ≤ 0.40 Tile ≤ 0.25
Impact Sound Insulation	EN ISO 717-2	dB	5	5	4
Residual indentation (norm)	EN ISO 24343-1	mm	≤ 0.10	≤ 0.10	≤ 0.10
Residual indentation (average measured value)	-	mm	≈ 0.02	≈ 0.02	≈ 0.03
Castor chair test (type H)	ISO 4918	-	OK	OK	OK
Thermal conductivity	EN ISO 10456	W/(m.k)	0.25	0.25	0.25
Colour fastness	EN ISO 105-B02	degree	≥ 6	≥ 6	≥ 6
Surface treatment	-	-	Evercare™	Evercare™	Evercare™
Chemical products resistance	EN ISO 26987	class	OK	OK	OK

Environment					
Recycled content (average)	-	%	25	25	25
Recyclability	-	%	100	100	100
EPD	-	-	Available	Available	Available

Health					
TVOC after 28 days	ISO 16000-6	microgram/m ³	< 10	< 10	< 10
Certification	-	-	Floorscore®	Floorscore®	Floorscore®
Anti-bacterial activity (E. coli - S. aureus - MRSA) after 24h ⁽²⁾	ISO 22196	-	> 99% inhibits growth	> 99% inhibits growth	> 99% inhibits growth
Anti-viral activity (human coronavirus) after 2h ⁽²⁾	ISO 21702	-	> 99.7% virucidal activity	> 99.7% virucidal activity	> 99.7% virucidal activity

CE Marking



EN 14041

(1) Products available in tiles for a minimum order quantity of 500 sqm.

(2) The implementation of an effective cleaning regime is the most important defence against infection.

Mipolam Homogeneous Evercare™

Mipolam Affinity

 Compact
 Compact
 608 x 608 mm
 Evercare™
 100% recyclable

 Matt finish

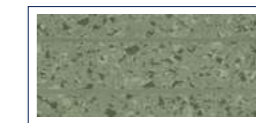
 ▶ MCR40⁽¹⁾
 ▶ CR40⁽²⁾



4476 Amethyst
 

^ Scale 1



4476 Amethyst - 4402 Yuki



(1)  Mentioned colors available with MCR40 specific multicolor welding rod (code: H058)
 (2) All colors available with CR40 matching uni welding rod (code: 0585)

Mipolam Homogeneous Evercare™

Mipolam Affinity

 Compact
 Compact
 608 x 608 mm
 Evercare™
 100% recyclable

 Matt finish

 ▶ MCR40⁽¹⁾
 ▶ CR40⁽²⁾



4402 Yuki
 

^ Scale 1



4402 Yuki - 4447 Light Emerald



(1)  Mentioned colors available with MCR40 specific multicolor welding rod (code: H058)
 (2) All colors available with CR40 matching uni welding rod (code: 0585)

Mipolam Homogeneous Evercare™

Mipolam Accord

 Compact
 Compact
 608 × 608 mm

Evercare™

 100% recyclable

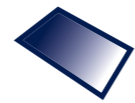

Matt finish

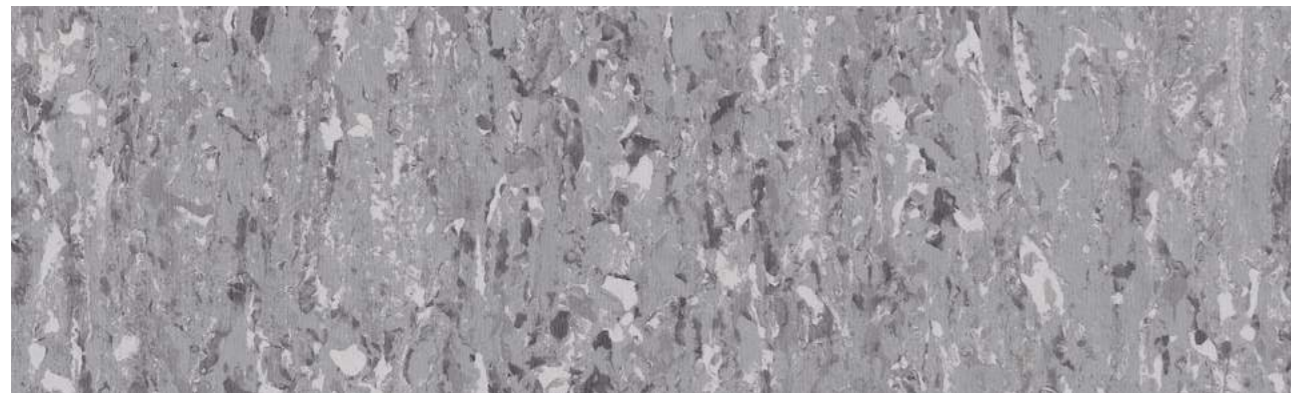
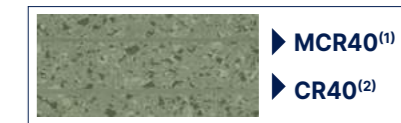

0330 Kruger



^ Scale 1



0330 Kruger / 0321 Salt

			
0321 Salt  	0301 Louise  	0305 Light Sand  	0332 Dore  
			
0312 Powell  	0303 Manitoba  	0324 Sand  	0447 Grunsee  
			
0310 Huron  	0319 Toba  	0441 Loch Ness  	0315 Orange River  
			
0306 Inari  	0320 Ontario  	0463 Bourget  	
			
0316 Malaren  	0450 Thames  	0443 Krumme  	
			
0346 Roxen  	0360 Balaton  	0459 Mississippi  	

Mipolam Homogeneous Evercare™

Mipolam Troplan

 Compact
 Compact
 608 × 608 mm

Evercare™

 100% recyclable

 Matt finish

Mipolam
Homogeneous



1004 Earth



1004 Earth

^ Scale 1



1032 Yellow



1055 Apricot



1002 Beige



1009 Light Grey



1006 Blue



1007 Green



1003 Light Ocre



1010 Grey

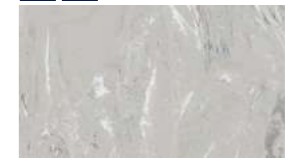

1036 Medium Blue



1037 Medium Green



1035 Ocre



1059 Blue Grey



1056 Dark Blue



1057 Dark Green



1033 Brown



1040 Dark Grey



1060 Anthracite

Mipolam Homogeneous Easycare

Mipolam Astro **New**

Mipolam Astro



MIPOLAM ASTRO is a vinyl flooring homogeneous **pressed** in 2m sheets, with a thickness of 2mm and a **weight of 2900 g**. The Non-directional design with colour throughout the thickness is available in 14 references presenting a nice **matt finish**. This flooring is suitable for medium to high traffic areas, and facilitates floor-wall junctions, angles and welding treatments. The flooring is equipped with **Easycare** offering **chemical resistance to the main products used in healthcare** environment as Betadine, eosin, hydro alcoholic solutions, making the maintenance easy and long lasting the flooring. This treatment **avoids applying any acrylic emulsion** throughout the lifetime of the product. It is composed of 74% sustainable raw materials, and **25% of recycled content**. It is free of formaldehyde, heavy metals and CMR 1 & 2 or vPvB (very persistent and very bio accumulative) or PBT (persistent, bio-accumulative and toxic) and is **REACH compliant**. It is 100% phthalates free and 100% recyclable. According to ISO 21702, **MIPOLAM ASTRO** has **anti viral activity** against Human Coronaviruses: it reduces the number of virus by 99,7% after 2h00. According to ISO 22196, **Mipolam Astro** has **anti bacterial activity** against E. coli, S. aureus and MRSA of 99% after 24h00. COV emissions after 28 days (ISO 16000-6) are below detection levels with <10 µg / m³ and this product is classified A + (the best class). The flooring is **antistatic** (<2kV), its residual indentation is ≤ 0.02 mm. The flooring is compliant with EN ISO 10581 norm, has a binder content type I, is suitable for heavy duty traffic areas and has **Bfl-s1** fire resistance.



Easycare



100% recyclable



Matt finish

Mipolam Homogeneous

- ▶ **Non directional design**
- ▶ **Perfect finishing**
 - Color matching welding rods
 - Coordinated with Gerflor wall coverings
- ▶ **Heavy traffic resistance**

- ▶ **Easy maintenance**
 - Easycare surface treatment
 - Recommended with Gerflor Clean Corner System and entrance mats

Mipolam Astro

Description			
Total thickness	EN ISO 24346	mm	2
Weight	EN ISO 23997	g/sqm	2900
Width of sheet	EN ISO 24341	cm	200
Length of sheet	EN ISO 24341	lm	20
Phthalate free	-	-	OK
Classification			
Norm / Product specification	-	-	EN ISO 10581
European classification	EN ISO 10874	class	34-43
Fire rating	EN 13501-1	class	Bfl-s1
Static electrical propensity	EN 1815	kV	≤ 2
Slip resistance	EN 16165:2021 – Appendix B (DIN 51 130)	class	R9
Performances			
Type Binder content	EN ISO 10581	type	I
Dimensional stability	EN ISO 23999	%	≤ 0.40
Impact Sound Insulation	EN ISO 717-2	dB	5
Residual indentation (norm)	EN ISO 24343-1	mm	< 0.10
Residual indentation (average measured value)	-	mm	≈ 0.02
Castor chair test (type H)	ISO 4918	-	OK
Thermal conductivity	EN ISO 10456	W/(m.k)	0.25
Colour fastness	EN ISO 105-B02	degree	≥ 7
Surface treatment	-	-	Easycare
Chemical products resistance	EN ISO 26987	class	OK
Environment			
Recycled content (average)	-	%	25
Recyclability	-	%	100
EPD	-	-	Available
Health			
TVOC after 28 days	ISO 16000-6	microgram/m ³	< 10
Certification	-	-	Floorscore®
Anti-bacterial activity (E. coli - S. aureus - MRSA) after 24h ⁽¹⁾	ISO 22196	-	> 99% inhibits growth
Anti-viral activity (human coronavirus 229E) after 2h ⁽¹⁾	ISO 21702	-	> 99.7% virucidal activity

CE Marking



EN 14041

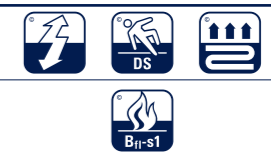

(1) The implementation of an effective cleaning regime is the most important defence against infection.

Mipolam Homogeneous Easycare

Mipolam Astro **New**



Compact
608 x 608 mm

Easycare



100% recyclable



Matt finish

Mipolam
Homogeneous



2496 Skiff / 2430 Panstarrs

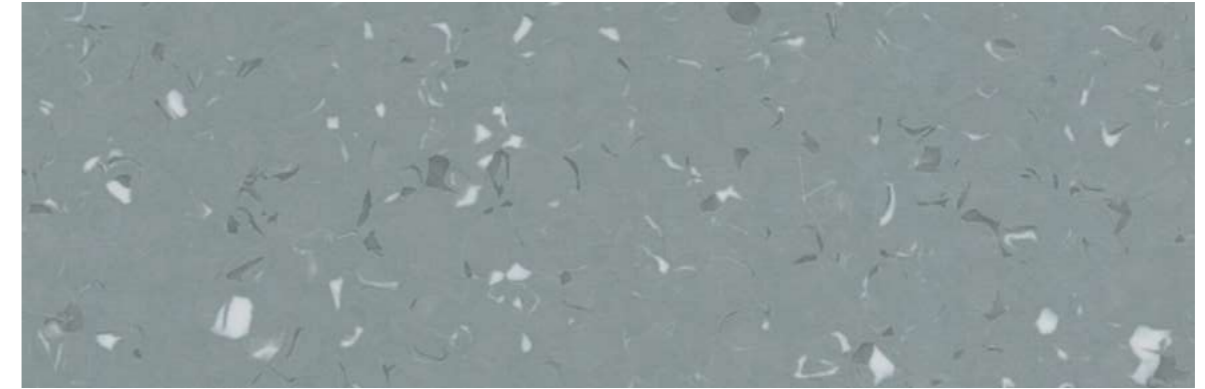

2430 Panstarrs

^ Scale 1

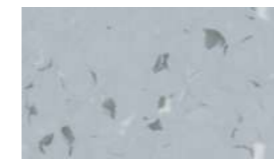

2410 Tempel



2408 Halley

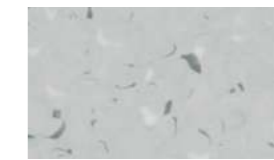

2411 Catalina



2401 Wise



2496 Skiff



2409 Soho



2441 Helin



2424 Biela



2446 Spacewatch

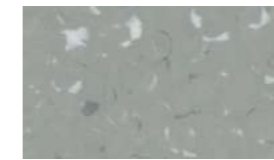

2413 Cineos



2463 Linear

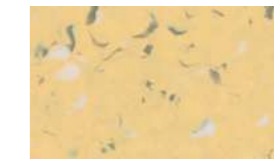

2432 Lemmon

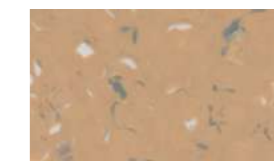

2425 Neat



Mipolam Homogeneous PUR

Mipolam Classic

Mipolam Classic

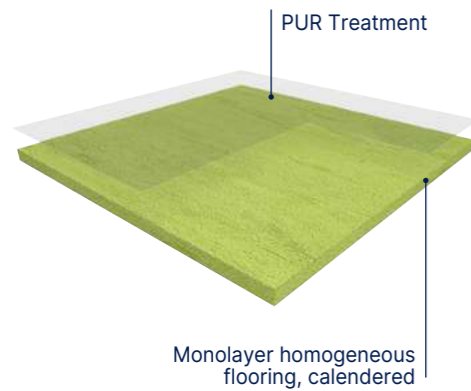

MIPOLAM CLASSIC 1.5 mm is a flexible homogeneous calendered compacted floorcovering in tiles or sheets, with directional design, colour dyed as a raw mixture to ensure even colour throughout the thickness of 1.5 mm and a **weight of ≤ 2520 g**. Its surface is densely compacted for improved wear and ease of maintenance. It receives a polyurethane (**PUR**) surface treatment for ease of maintenance and to avoid the use of an immediate acrylic emulsion after installation. The flooring complies with the **EN ISO 10874** (34-43) and EN ISO 10581, has a binder content type II, has Bfl-s1 fire resistance. It is suitable for heavy traffic areas. It is 100% recyclable. Its VOC emissions after 28 days (ISO 16000-6) are below detection levels (< 10 microgram/m³) and this product is classified A + (the best class).

MIPOLAM CLASSIC 2 mm is a flexible homogeneous calendered compacted floorcovering in tiles or in 2 m sheets, with a thickness of 2 mm and a **weight of ≤ 3300 g**. This directional design, colour dyed as a raw mixture to ensure even colour throughout the thickness is available in 14 references. Its surface is densely compacted for improved wear and ease of maintenance. It receives a polyurethane (**PUR**) surface treatment for ease of maintenance and to avoid the use of an immediate acrylic emulsion after installation. The flooring complies with the **EN ISO 10874** (34-43) and EN ISO 10581, has a binder content type II, has Bfl-s1 fire resistance. It is suitable for heavy traffic areas. It is 100% recyclable. Its VOC emissions after 28 days (ISO 16000-6) are below detection levels (< 10 microgram/m³) and this product is classified A + (the best class).

Mipolam Classic

Description				
Total thickness	EN ISO 24346	mm	1.5	2
Weight	EN ISO 23997	g/sqm	2520	3300
Width of sheet	EN ISO 24341	cm	200	200
Length of sheet	EN ISO 24341	lm	20	20
Tile size	EN ISO 24342	mm	-	300 × 300 ⁽¹⁾ / 608 × 608
Number of tiles per package	-	-	-	50 / 20
Classification				
Norm / Product specification	-	-	EN ISO 10581	EN ISO 10581
European classification	EN ISO 10874	class	23-31	34-43
Fire rating	EN 13501-1	class	Bfl-s1	Bfl-s1
Static electrical propensity	EN 1815	kV	< 2	< 2
Performances				
Type Binder content	EN ISO 10581	type	II	II
Dimensional stability	EN ISO 23999	%	≤ 0.40	Sheet ≤ 0.40 / Tile ≤ 0.25
Impact Sound Insulation	EN ISO 717-2	dB	-	4
Residual indentation (norm)	EN ISO 24343-1	mm	≤ 0.10	≤ 0.10
Residual indentation (average measured value)	-	mm	≈ 0.03	≈ 0.03
Castor chair test (type H)	ISO 4918	-	OK	OK
Thermal conductivity	EN ISO 10456	W/(m.k)	0.25	0.25
Colour fastness	EN ISO 105-B02	degree	≥ 6	≥ 6
Surface treatment	-	-	PUR	PUR
Chemical products resistance	EN ISO 26987	class	OK	OK
Environment				
Recycled content (average)	-	%	25	25
Recyclability	-	%	100	100
EPD	-	-	Available	Available
Health				
TVOC after 28 days	ISO 16000-6	microgram/m ³	< 10	< 10
Certification	-	-	Floorscore®	Floorscore®
CE Marking				



EN 14041



(1) Tiles (300 × 300 mm) available for a minimum order quantity of 500 sqm.



0002 Platinum

▲ Scale 1



0108 Pepper



0122 Pineapple



0123 Corallo

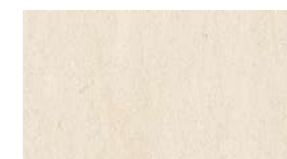

0301 Beige



0005 Steel



0010 Azure



0121 Green Leaf



0003 Ivory



0303 Grey



0013 Pewter



0124 Tortora

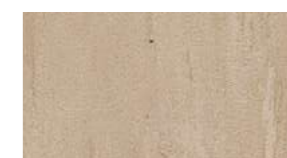

0014 Brown

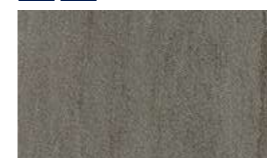

0125 Truffle



All colours available as 300 × 300mm tiles upon request for a minimum order quantity of 500 sqm.
▲ Thickness: 1.5 mm - Sheet format only



Taralay Multilayered

pages 52-343

- 56. Taralay Millenium
- 60. Taralay Libertex **New**
- 66. Taralay Impression
Taralay Impression **hop**
- 92. My Taralay Impression
- 96. Taralay Initial **New**

Taralay Multilayered

Premium
See pages 8/23

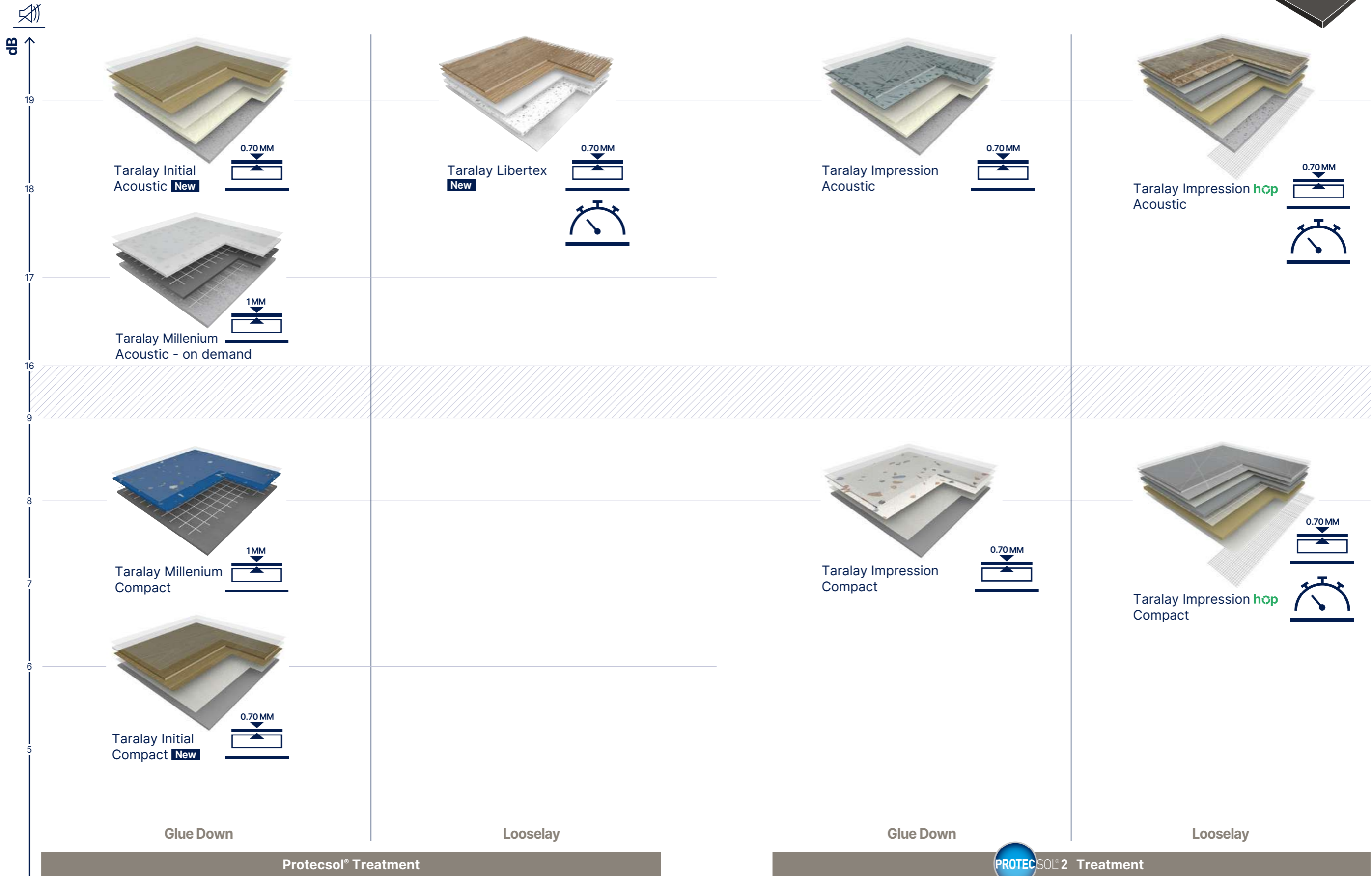

Taralay Multilayered

— Maintenance +

Taralay Multilayered

Taralay Millenium

Taralay Millenium Compact

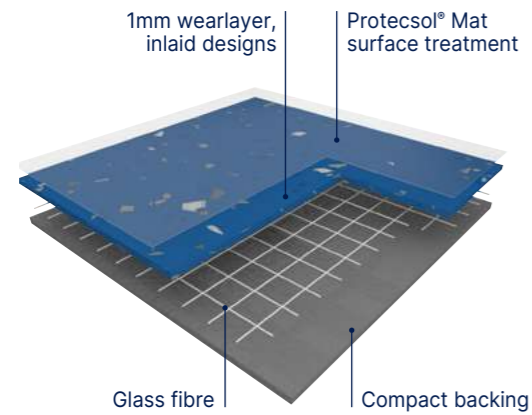

TARALAY MILLENIUM COMPACT is a multilayered vinyl floor covering available in 2m wide sheet, with a group T wear rating. The product comprises a **1 mm thick coated wear layer, made of pure vinyl, coloured throughout its thickness (no transparent wear layer and no filler)**. Its complete thickness is 2 mm. It is reinforced with a fibre glass grid for a better dimensional stability. The construction of the product yields a 8dB sound insulation rating and a **resistance to indentation of 0.03 mm**.

This flooring is protected by the surface treatment, **Protecsol® Mat**, with a minimum thickness of 13µm, ensuring easy maintenance and no required polish for the entire lifetime of the product.

It is composed of 50% mineral and inexhaustible materials. It does not contain any heavy metals or CMR 1&2 components and it is 100% compliant with REACH. The product emission rate of volatile organic compounds is <10 micrograms/m³ (TVOC after 28 days ISO 16000-6).

It is 100% recyclable.

Taralay Millenium Acoustic (on demand)

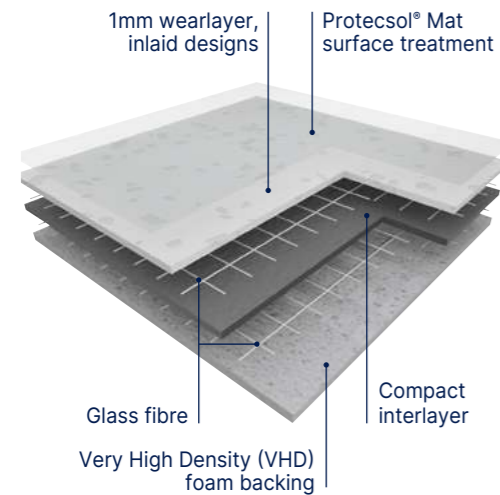

TARALAY MILLENIUM ACOUSTIC is a multilayered vinyl floorcovering available in 2m wide sheet, with a group T wear rating. The product comprises a **1 mm thick coated wear layer, made of pure vinyl, coloured throughout its thickness (no transparent wear layer and no filler)**. Its complete thickness is 3.4 mm. It contains a Very High Density (VHD) foam backing and is reinforced with 2 fibre glass grids which yields a **17dB sound insulation** rating and a **resistance to indentation of 0.07 mm**.

This flooring is protected by the surface treatment, **Protecsol® Mat**, with a minimum thickness of 13µm, ensuring easy maintenance and no required polish for the entire lifetime of the product.

It is composed of 50% mineral and inexhaustible materials. It does not contain any heavy metals or CMR 1&2 components and it is 100% compliant with REACH. The product emission rate of volatile organic compounds is <10 micrograms/m³ (TVOC after 28 days ISO 16000-6).

It is 100% recyclable.



- **Design within the whole thickness – no filler**
Outstanding abrasion resistance
- **Very high density (VHD) foam backing**
Easy rolling for loads
- **Protecsol® Mat Surface Treatment**
Easy cleaning
- **100 % Recyclable**
Eco-responsible solutions

Description			Taralay Millenium Compact	Taralay Millenium Acoustic*
	Total thickness	EN ISO 24346	mm	2.00
Thickness of wearlayer	EN ISO 24340	mm	1	1
Weight	EN ISO 23997	g/sqm	2725	3385
Width of sheet	EN ISO 24341	cm	200	200
Length of sheet	EN ISO 24341	lm	20	25
Classification				
Norm / Product specification	-	-	EN ISO 10582	ISO 11638 (EN 651)
European classification	EN ISO 10874	class	34-43	34-42
Fire rating	EN 13501-1	class	Bfl-s1	Cfl-s1
Static electrical propensity	EN 1815	kV	< 2	< 2
Slip resistance wet	EN 16165:2021 – Appendix B (DIN 51 130)	class	R10	R10
Performances				
Wear resistance	EN 660.2	mm ³	≤ 2.0	≤ 2.0
Wear group	-	group	T	T
Type Binder content	EN ISO 10582	type	I	-
Dimensional stability	EN ISO 23999	%	≤ 0.40	≤ 0.40
Residual indentation (requirement)	EN ISO 24343-1	mm	≤ 0.10	≤ 0.20
Residual indentation (average measured value)	-	mm	≈ 0.03	0,07
Impact sound insulation	EN ISO 717-2	dB	8	17
Castor chair test (type H)	ISO 4918	-	OK	OK
Thermal conductivity	EN ISO 10456	W/(m.k)	0.25	0.25
Colour fastness	EN ISO 105-B02	degree	≥ 6	≥ 6
Surface treatment	-	-	Protecsol® Mat	Protecsol® Mat
Chemical products resistance	EN ISO 26987	-	OK	OK
Environment				
Recyclability	-	%	100	100
Health				
TVOC after 28 days	ISO 16000-6	microgram/m ³	< 10	< 10
Certification	-	-	Floorscore®	Floorscore®
Anti-bacterial activity (E. coli - S. aureus - MRSA) ⁽¹⁾	ISO 22196	-	> 99% inhibits growth	> 99% inhibits growth
Anti-viral activity (human coronavirus) after 2h ⁽¹⁾	ISO 21702	-	> 99.3% virucidal activity	> 99.3% virucidal activity
CE marking				



(1) The implementation of an effective cleaning regime is the most important defence against infection.
*available on demand (minimum order quantity: 1000 sqm)

Taralay Multilayered

Taralay Millenium - Cosmic



 17 dB
 
 Protacosol® Mat
 
 100% recyclable

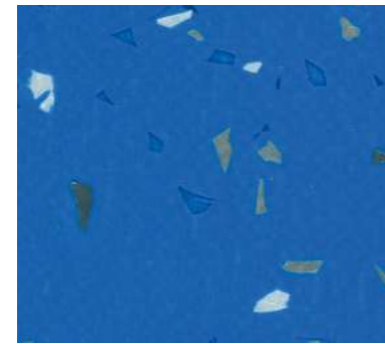

5718 Pallas 



5718 Pallas

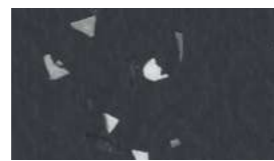

8856 Pandore 

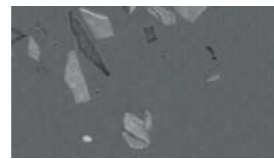

5728 Ilias 



5723 Lotis 



5721 Fortuna 



3442 Doris 



3438 Iris 



4162 Adonis 

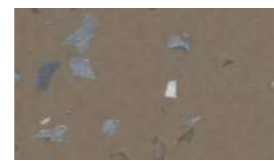

4038 Delia 



4369 Egeria 



4036 Vesta 



4368 Astree 



4037 Gyptis 



4533 Ceres 



3435 Nemesis 



4161 Hilda 

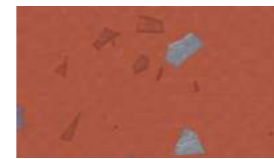

4160 Hermione 



4159 Kalliope 



8645 Bianca 



4374 Aria 



4532 Sylvia 



4531 Camilla 

*Acoustic: available on demand (minimum order quantity: 1000 sqm)

Taralay Millenium - Stellar



 17 dB
 
 Protacosol® Mat
 
 100% recyclable



4163 Flore

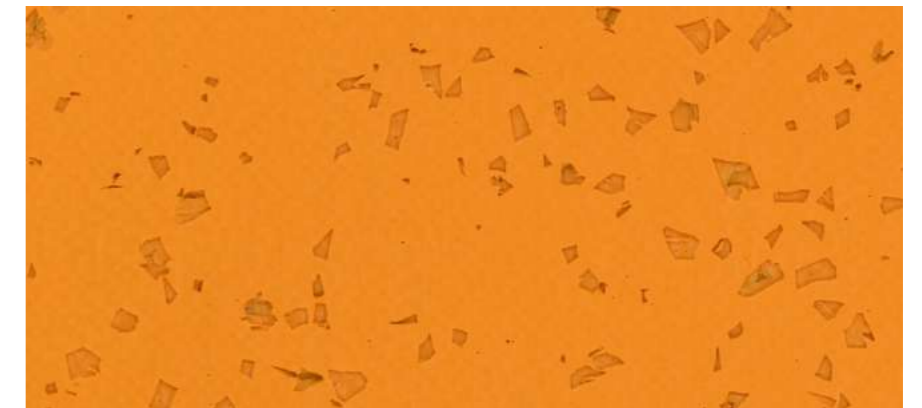

4163 Flore 



3446 Eden 



4039 Pan 



5724 Chicago 



4200 Apolon 



4373 Fudo 



4372 Boree 



4164 Eros 

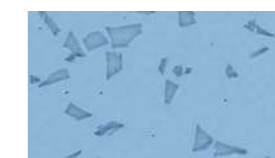

3439 Europa 



5726 Yuna 



5725 Freia 

*Acoustic: available on demand (minimum order quantity: 1000 sqm)

Taralay Multilayered - fast track installation

Taralay Libertex **New**



34

High traffic resistance
0.7mm wearlayer



19 dB

Comfort
Max³ Layer system



Circular Economy
100% recyclable product



Indoor Air Quality
Adhesive Free installation means virtually no VOC!

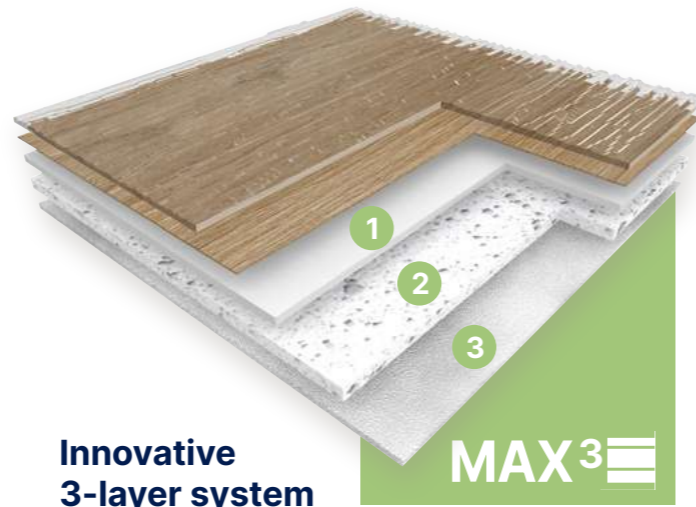

Innovative 3-layer system

- 1 High density foam complexed with fiber glass
- 2 Acoustic foam layer
- 3 Reinforced textile backing

MAX³



19 dB

ProtecSol®



100% recyclable



Textile Backing

Valencay



1442 Valencay Pecan

16 x 100 cm



0368 Valencay Blond

16 x 100 cm



0179 Valencay Patine

16 x 100 cm

Pure Oak



1751 Pure Oak Grey

16 x 100 cm



0720 Pure Oak Clear

16 x 100 cm

Habana



0797 Habana Ivory

20 x 133.3 cm



0828 Habana Beige

20 x 133.3 cm

Azay Cream



2346 Azay Cream

10 x 35 cm

Fast track renovation



No shutdown
No odor, no glue, minimum facility downtime



Renovation
on existing subfloor

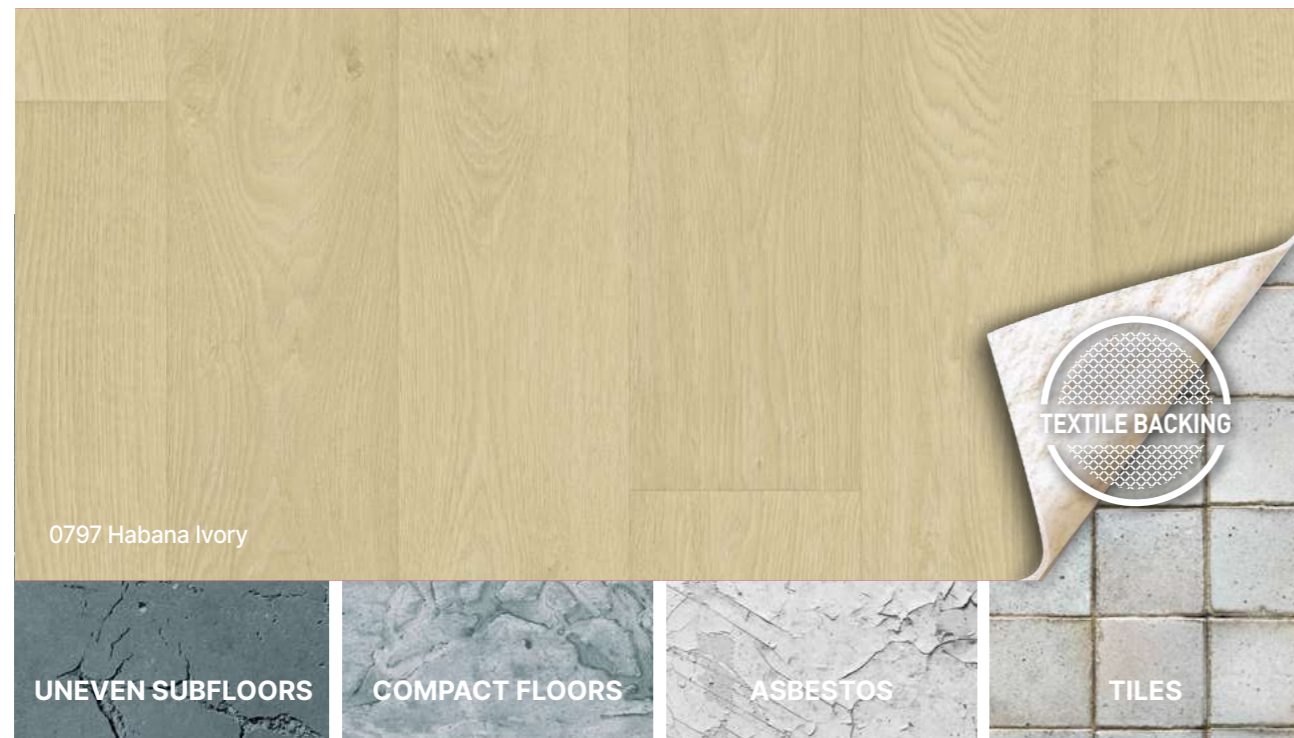

2346 Azay Cream

Taralay Multilayered - fast track installation

Taralay Libertex **New**

 Textile Backing
 19 dB
Protocolsol®
 100% recyclable



Textile Backing



2226 Cordoba Black & White / 2413 Cottage Blond

Cottage



2415 Cottage Clear  20 x 133,3 cm



2413 Cottage Blond  20 x 133,3 cm



2426 Cottage Brown  20 x 133,3 cm

Esterel Blond



0636 Esterel Blond  10 x 100 cm

Cordoba Black & White



2226 Cordoba Black & White  25 x 25 cm



2284 Chicago Storm

Chicago



2460 Chicago Cream  ^ Scale 1



2459 Chicago Haze 

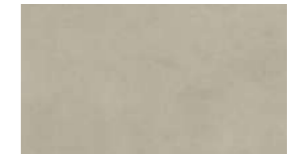

2366 Chicago Sand 



2284 Chicago Storm 

Rough



2225 Rough Light Grey  ^ Scale 1



2218 Rough Taupe 



2219 Rough Chocolate 

Taralay Multilayered - fast track installation

Taralay Libertex New

Taralay Libertex

TARALAY LIBERTEX is ideal for fast track installation or renovations in commercial buildings. It is a multi-layered vinyl floorcovering with a printed design protected by a 0.70 mm thick transparent wear layer. The product features a high density foam complexed with fiber glass, an acoustic foam layer and a reinforced textile backing. It offers **19 dB sound insulation**.

It is available in 2 m and 4 m wide sheet, offers a R10 slip resistance and a group T wear rating. It is mechanically embossed, benefits from **Protectsol®** surface treatment and has an ultra matt look.

TARALAY LIBERTEX is a worry-free looselay solution. It is laid without glue, simply applying a double-sided tape such as Fix&Free on room edge and at the joint. Its textile backing absorbs surface irregularities requiring minimal subfloor preparation on uneven floors. It is compatible with cold welding, hot welding, coving, and Vynaflex skirtings.

It includes at least 30% mineral materials and 20% renewable materials. Textile backing is made at 95% from recycled PET bottles. It is 100% recyclable and 100% REACH compliant. Its VOC emissions after 28 days (ISO 16000) are below 100 microgram/m³. It is classified A + (the best class) for indoor air quality.

Fast installation in one solution!



Adhesive free

Apply double-sided tape (such as Fix&Free 100 Ref. 058U) on welding area and on room edges



Hot welding

for 100% watertight hygienic system (Ref. CR40 0585)



Cold welding

for invisible joint (see Romus #95605)



Wall transition

- Vynaflex skirtings, ideal for commercial applications (H 60 mm - Ref. 0483 / H 80 mm - Ref. 0482 / H 100 mm - Ref. 0477)
- Coving for 100% watertight hygienic system



Entrance Mats

A new quick & easy installation of entrance mats with KIT ESPLANADE 9000 (Ref. 1700) or ROMAT GT (Ref. 1719)



More information on gerflor.com



19 dB

Protectsol®



100% recyclable

Fast track installation

- Minimal subfloor preparation: textile backing absorbs subfloor irregularities
- No shutdown, no odor, ideal for occupied rooms thanks to looselay installation
- No drying time, no glue

Hygienic and easy maintenance: Protectsol® surface treatment

Comfort: 19 dB sound reduction

Libertex			
Description			
Total thickness	EN ISO 24346	mm	3.65
Thickness of wearlayer	EN ISO 24340	mm	0.70
Weight	EN ISO 23997	g/sqm	2900
Width of sheet	EN ISO 24341	cm	200/400
Length of sheet	EN ISO 24341	lm	20
Phthalate free	-	-	OK
Classification			
Norm / Product specification	-	-	EN ISO 11638
European classification	EN ISO 10874	class	34-43
Fire rating	EN 13501-1	class	Cfl-s1
Static electrical propensity	EN 1815	kV	< 2
Slip resistance wet	EN 16165:2021 - Appendix B (DIN 51 130)	class	R10
Performances			
Wear resistance	EN 660.2	mm ³	≤ 2.0
Wear group	-	group	T
Dimensional stability (requirement)	EN ISO 23999	%	≤ 0.40
Dimensional stability (measured value)	-	-	≤ 0.05
Residual indentation (requirement)	EN ISO 24343-1	mm	≤ 0.20
Impact sound insulation	EN ISO 717-2	dB	19
Room impact	NF S 31 074	dB	< 65
Thermal conductivity	EN ISO 10456	W/(m.k)	0.25
Colour fastness	EN ISO 105-B02	degree	≥ 6
Surface treatment	-	-	Protectsol®
Chemical products resistance ⁽¹⁾	EN ISO 26987	-	OK
Environment			
Recyclability	-	%	100
EPD	-	-	Available
Health			
TVOC after 28 days	ISO 16000-6	microgram/m ³	< 100
CE marking			



EN 14041



(1) Regarding the resistance to chemicals, please download the corresponding leaflet from our website.

Taralay Multilayered

Taralay Impression

Taralay Impression Compact

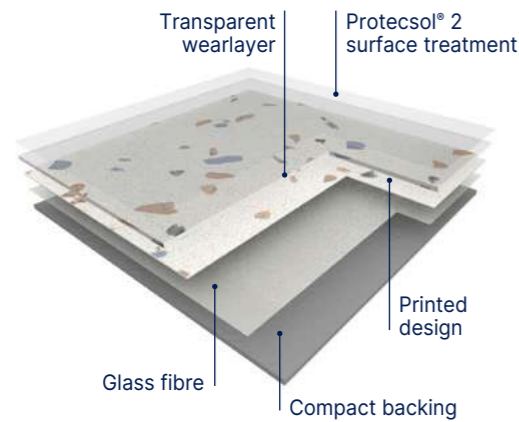

TARALAY IMPRESSION COMPACT 0,7 is a multi-layered vinyl floorcovering, integrating a fiber glass and a printed design. It's available in 2 m wide sheet, with a group T wear rating. Total width of the product is 2 mm, including a transparent wear layer of 0.70 mm thick. **It offers 8 dB sound insulation and an indentation resistance of ca. 0.03 mm.** Its **dimensional stability** performs down to 0,08% (average measure). **TARALAY IMPRESSION COMPACT** is made in France. It's **100% recyclable**, and the floorcovering will have its individual EPD sheet. The flooring is equipped with **Protocolsol® 2**, patented surface treatment obtained by UV laser cross-linking offering the best chemical resistance to the main products used in healthcare environment as betadine, eosin, hydro alcoholic solutions, making the maintenance easy and the floor long lasting. This treatment avoids applying any acrylic emulsion throughout the lifetime of the product. It is **free of formaldehyde, heavy metals and CMR 1 & 2 or vPvB** (very persistent and very bio accumulative) or PBT (persistent, bio-accumulative and toxic) and is 100% REACH compliant. Its VOC emissions after 28 days (ISO 16000-6) are below detection levels (<10 µg / m³) and this product is classified A + (the best class) and Floorscore® & M1 certified for indoor air quality. Taralay Impression Compact has antibacterial efficacy (E.coli / S.aureus / MRSA): >99% after 24 hours according to ISO22196.

Taralay Impression Acoustic

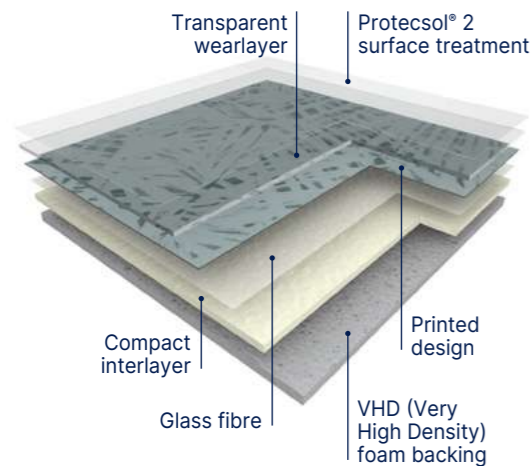

TARALAY IMPRESSION ACOUSTIC 0,65 is a multi-layered vinyl floorcovering, integrating a **Very High Density foam backing**, reinforced with a fiber glass and a printed design. It's available in 2 m wide sheet, with a group T wear rating. Total width of the product is **3,35 mm**, including a transparent wear layer of 0.65 mm thick. It offers **19 dB sound insulation and an indentation resistance of ca. 0.08 mm.** Its **dimensional stability** performs down to **0,08%** (average measure). **TARALAY IMPRESSION ACOUSTIC** is made in France, with green electricity. It's **100% recyclable**, and the floorcovering will have its individual EPD sheet. The flooring is equipped with **Protocolsol® 2**, patented surface treatment obtained by UV laser cross-linking offering the best chemical resistance to the main products used in healthcare environment as betadine, eosin, hydro alcoholic solutions, making the maintenance easy and the floor long lasting. This treatment avoids applying any acrylic emulsion throughout the lifetime of the product. It is **free of formaldehyde, heavy metals and CMR 1 & 2 or vPvB** (very persistent and very bio accumulative) or PBT (persistent, bio-accumulative and toxic) and is 100% REACH compliant. Its VOC emissions after 28 days (ISO 16000-6) are below detection levels (<10 µg / m³) and this product is classified A + (the best class) and Floorscore® & M1 certified for indoor air quality. Taralay Impression Compact has antibacterial efficacy (E.coli / S.aureus / MRSA): >99% after 24 hours according to ISO22196.



- **Ultra-realistic designs:** Realistic embosses and plank dimensions for wood designs
- **Matt effect**
- **Extreme stain resistance, easy maintenance:** Protocolsol® 2 surface treatment (patented technology by Gerflor)
- **High traffic resistance, long-lasting appearance** Available with a 0.7 mm wearlayer and available with a 0.9 mm wearlayer upon request (minimum order quantity of 800 sqm)
- **The best acoustic / indentation performance on the market**
COMPACT: 0.03 mm / 8 dB
ACOUSTIC: 0.08 mm / 19 dB
- **Eco-responsible solution**
Best in class for indoor air quality (TVOC < 10 microgram/m³ after 28 days)

Description			Taralay Impression Compact	Taralay Impression Acoustic
Total thickness	EN ISO 24346	mm	2.00	3.35
Wearlayer Thickness	EN ISO 24340	mm	0.70	0.65
Weight	EN ISO 23997	g/sqm	2635	2825
Width of sheet	EN ISO 24341	cm	200	200
Length of sheet	EN ISO 24341	lm	25	25
Phthalate free	-	-	OK	OK
Classification				
Norm / Product specification	-	-	EN ISO 10582	EN ISO 11638
European classification	EN ISO 10874	class	34-43	34-42
Fire rating	EN 13501-1	class	Bfl-s1	Bfl-s1
Static electrical propensity	EN 1815	kV	< 2	< 2
Slip resistance	EN 16165:2021 – Appendix B (DIN 51 130)	class	R10	R10
Performances				
Wear resistance	EN 660.2	mm ³	≤ 2.0	≤ 2.0
Wear group	-	group	T	T
Type Binder content	EN ISO 10582	type	I	-
Dimensional stability (requirement)	EN ISO 23999	%	≤ 0.40	≤ 0.40
Dimensional stability (measured value)	-	%	0,08	0,08
Residual indentation (requirement)	EN ISO 24343-1	mm	≤ 0.10	≤ 0.20
Residual indentation (average measured value)	-	mm	≈ 0.03	≈ 0.08
Impact sound insulation	EN ISO 717-2	dB	8	19
Castor chair test (type H)	ISO 4918	-	OK	OK
Thermal conductivity	EN ISO 10456	W/(m.k)	0.25	0.25
Colour fastness	EN ISO 105-B02	degree	≥ 6	≥ 6
Surface treatment	-	-	PROTECSOL® 2	PROTECSOL® 2
Chemical products resistance ⁽¹⁾	EN ISO 26987	-	OK	OK
Environment				
Recycled content (average)	-	%	14	17
Recyclability	-	%	100	100
EPD	-	-	Available	Available
Health				
TVOC after 28 days	ISO 16000-6	microgram/m ³	< 10	< 10
Certification	-	-	Floorscore®	Floorscore®
Anti-bacterial activity (E. coli - S. aureus - MRSA) after 24h ⁽²⁾	ISO 22196	-	> 99% inhibits growth	> 99% inhibits growth
Anti-viral activity (human coronavirus) after 2h ⁽²⁾	ISO 21702	-	> 99.7% virucidal activity	> 99.7% virucidal activity
CE Marking				



EN 14041



(1) Regarding the resistance to chemicals, please download the corresponding leaflet from our website.
(2) The implementation of an effective cleaning regime is the most important defence against infection.

Taralay Multilayered

Taralay Impression **hop**: the looselay solution



Eco-design valued at each stage of the life cycle

GERFLOR COMMITTED

to communicating transparently about the carbon impact of its products and focusing on eco-design, including the use of sustainable raw materials, the sustainability of its products and circular economy

1- Raw materials

+ 23% Recycled content

TVOC < 10 micrograms/m³

Reach compliant*

4- A second life made easier

100% RECYCLABLE 100% recyclable

Uninstall and re-use:
 • Flooring can be uninstalled without damaging either the product or the surface underneath
 • Flooring can be re-used for another building

Easy to recycle
 • Qualifies for the **the Second Life Programme**
 • Flooring is incorporated back into our production lines

FLOOR TO FLOOR A unique partnership with Paprec, recycling programmes that are certified by Europlast



Accelerating recycling is essential for building a more circular economy. Preserving resources and reducing the carbon footprint of our business are our commitments for Sustainable Development.

* Registration, Evaluation and Authorisation of Chemicals

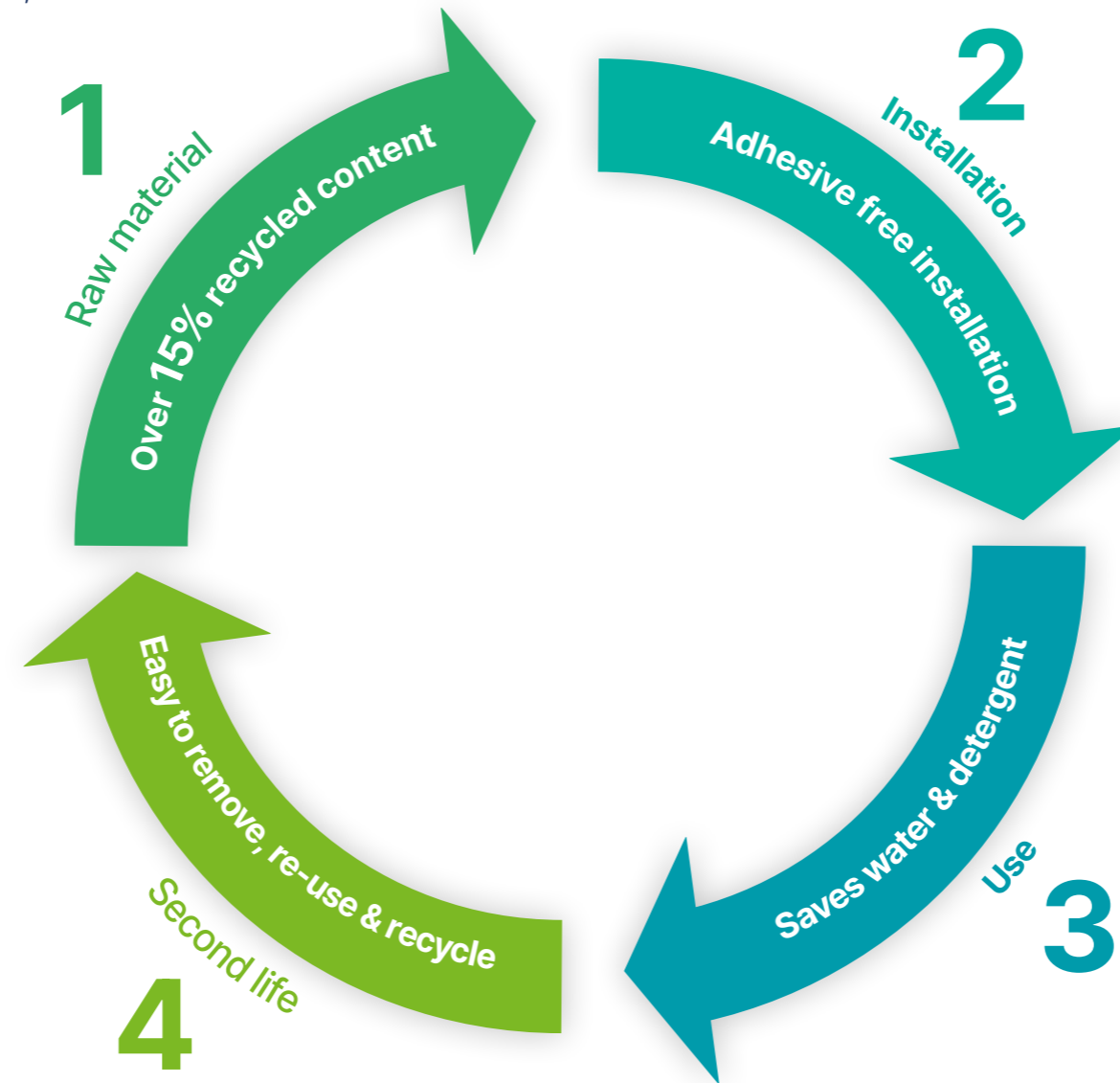

2- Installation

made easy in busy environments

hop Reinforced holding tape!

Adhesive free

Reduced downtime

Qualifies for the **Second Life Programme**

3- Use

Long-lasting performance

Protecsol® 2: stain resistant water-repellent surface saves water and detergent

Withstands wheeling heavy loads (straight or circular) up to 500 kg

Excellent resistance to indentation 0.03 mm (compact) / 0.08mm (acoustic)

Excellent stability, even during temperature changes: expansion < 0.03%

Improved resistance to moisture

Taralay Multilayered

Taralay Impression hop

Taralay Impression hop Compact

TARALAY IMPRESSION HOP COMPACT 0,7 is a multi-layered vinyl floorcovering, integrating a **double fiber frame** and a printed design. It's available in 2 m wide sheet, with a group T wear rating.

The system TARALAY IMPRESSION HOP COMPACT - floorcovering + holding tape « HOP tape », code 059E0001- enables to **lay down flooring gluefree**.

Thanks to its **double fiber frame** -fiber veil + fiber grid-, and its calendared interlayer, the floorcovering achieves a **high level of stability**, even under temperature variations and heavy rolling loads. It can be laid down onto **various existing supports**, including asbestos. Perfectly suitable for renovation or new buildings construction.

Without any glue, its **end life removal is fast and easy**. The Gerflor holding tape doesn't affect the support, to ease renovation. Re-use of the floorcovering, recycle or renovation are then facilitated.

Total width of the product is **2,30 mm**, including a transparent wear layer of 0.70 mm thick. It offers **8 dB sound insulation** and an **indentation resistance of ca. 0.03 mm**. Its **dimensional stability** performs down to **0,03%** (average measure).

TARALAY IMPRESSION HOP COMPACT is made in France and contains 23% of recycled content.

The flooring is equipped with **Protecsol® 2**, patented surface treatment obtained by UV laser cross-linking offering the best chemical resistance to the main products used in healthcare environment as betadine, eosin, hydro alcoholic solutions, making the maintenance easy and the floor long lasting. This treatment avoids applying any acrylic emulsion throughout the lifetime of the product.

It is **free of formaldehyde, heavy metals and CMR 1 & 2 or vPvB** (very persistent and very bio accumulative) or PBT (persistent, bio-accumulative and toxic) and is 100% REACH compliant. Its VOC emissions after 28 days (ISO 16000-6) are below detection levels (<10 µg / m³) and this product is classified A + (the best class) and Floorscore® & M1 certified for indoor air quality. Taralay Impression Compact has antibacterial efficacy (E.coli / S.aureus / MRSA): >99% after 24 hours according to ISO22196.

It's **100% recyclable**, and the floorcovering will have its individual EPD sheet.

Taralay Impression hop Acoustic

TARALAY IMPRESSION HOP ACOUSTIC 0,7 is a multi-layered vinyl floorcovering, integrating a **double fiber frame**, a **Very High Density foam** backing and a printed design. It's available in 2 m wide sheet, with a group T wear rating.

The system TARALAY IMPRESSION HOP ACOUSTIC - floorcovering + holding tape « HOP tape », code 059E0001- enables to **lay down flooring gluefree**.

Thanks to its **double fiber frame** -fiber veil + fiber grid-, and its **calendared interlayer**, the floorcovering achieves a **high level of stability**, even under temperature variations and heavy rolling loads. It can be laid down onto **various existing supports**, including asbestos. Perfectly suitable for renovation or new buildings construction.

Without any glue, its **end life removal is fast and easy**. The Gerflor holding tape doesn't affect the support, to ease renovation. Re-use of the floorcovering, recycle or renovation are then facilitated.

Total width of the product is **4,35 mm**, including a transparent wear layer of 0.70 mm thick. It offers **19 dB sound insulation** and an **indentation resistance of ca. 0.08 mm**. Its **dimensional stability** performs down to **0,03%** (average measure).

TARALAY IMPRESSION HOP ACOUSTIC is made in France and contains 23% of recycled content.

The flooring is equipped with **Protecsol® 2**, patented surface treatment obtained by UV laser cross-linking offering the best chemical resistance to the main products used in healthcare environment as betadine, eosin, hydro alcoholic solutions, making the maintenance easy and the floor long lasting. This treatment avoids applying any acrylic emulsion throughout the lifetime of the product.

It is **free of formaldehyde, heavy metals and CMR 1 & 2 or vPvB** (very persistent and very bio accumulative) or PBT (persistent, bio-accumulative and toxic) and is 100% REACH compliant. Its VOC emissions after 28 days (ISO 16000-6) are below detection levels (<10 µg / m³) and this product is classified A + (the best class) and Floorscore® & M1 certified for indoor air quality. Taralay Impression Compact has antibacterial efficacy (E.coli / S.aureus / MRSA): >99% after 24 hours according to ISO22196.

It's **100% recyclable**, and the floorcovering will have its individual EPD sheet.

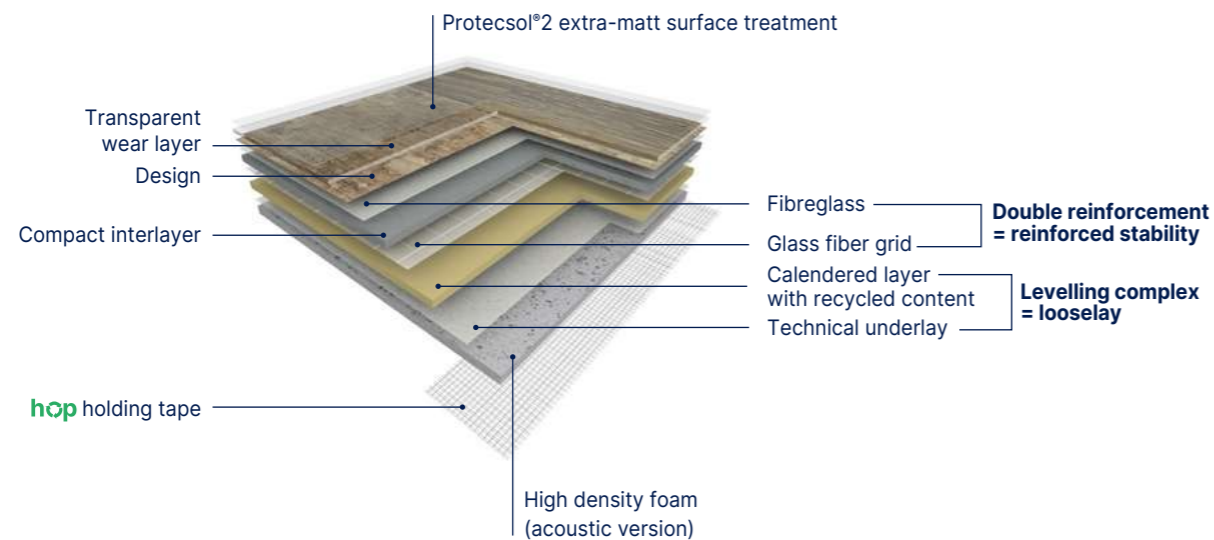

- **Innovative & eco designed solution for looselay installation**
- **Gluefree solution means quick and easy:** save up to 50% installation time
- **23% recycled content inside**
- **Protecsol®2 surface treatment:** the best stain resistance thanks to water-repellent properties
- **Acoustic version:** VHD foam for an acoustic insulation (-19db) - walking wellness and low impact sound

Description	Taralay Impression hop Compact		Taralay Impression hop Acoustic	
Classification				
Norm / Product specification	-	-	EN ISO 10582	EN ISO 11638
European classification	EN ISO 10874	class	34-43	34-42
Fire rating	EN 13501-1	class	Bfl-s1	Bfl-s1
Static electrical propensity	EN 1815	kV	< 2	< 2
Slip resistance	EN 16165:2021 - Appendix B (DIN 51 130)	class	R10	R10
Performances				
Wear resistance	EN 660.2	mm³	≤ 2.0	≤ 2.0
Wear group	-	group	T	T
Type Binder content	EN ISO 10582	type	I	I
Dimensional stability (requirement)	EN ISO 23999	%	≤ 0.40	≤ 0.40
Dimensional stability (measured value)	-	%	0,03	0,03
Residual indentation (requirement)	EN ISO 24343-1	mm	≤ 0.10	≤ 0.20
Residual indentation (average measured value)	-	mm	≈ 0.03	≈ 0.08
Impact sound insulation	EN ISO 717-2	dB	8	19
Castor chair test (type H)	ISO 4918	-	OK	OK
Thermal conductivity	EN ISO 10456	W/(m.k)	0.25	0.25
Colour fastness	EN ISO 105-B02	degree	≥ 6	≥ 6
Surface treatment	-	-	PROTECSOL® 2	PROTECSOL® 2
Chemical products resistance ⁽¹⁾	EN ISO 26987	-	OK	OK
Environment				
Recycled content (average)	-	%	23	23
Recyclability	-	%	100	100
EPD	-	-	Available	Available
Health				
TVOC after 28 days	ISO 16000-6	microgram/m³	< 10	< 10
Certification	-	-	Floorscore®	Floorscore®
Anti-bacterial activity (E. coli - S. aureus - MRSA) after 24h ⁽²⁾	ISO 22196	-	> 99% inhibits growth	> 99% inhibits growth
Anti-viral activity (human coronavirus) after 2h ⁽²⁾	ISO 21702	-	> 99.7% virucidal activity	> 99.7% virucidal activity
CE Marking				
CE	EN 14041			

(1) Regarding the resistance to chemicals, please download the corresponding leaflet from our website.
 (2) The implementation of an effective cleaning regime is the most important defence against infection.

Taralay Multilayered

Taralay Impression / Taralay Impression **hop**

 Compact
  Acoustic
 19 dB
  Protectsol® 2
  100% recyclable



1104 Wood Fusion Nature

Wood Fusion



1104 Wood Fusion Nature   Scale 5% Digital print 20 cm



1100 Habana 3D Blossom

Habana 3D



1100 Habana 3D Blossom   Scale 10% Digital print 16,6 cm



1069 Habana 3D Trinidad  16,6 cm



1070 Habana 3D Vinales  16,6 cm



1110 Rivau Nature

Rivau Nature



1110 Rivau Nature   Scale 30% 7 x 35 cm

*Available in Taralay Impression **hop**



1077 Raintree Natural

Raintree



1077 Raintree Natural  2,5 cm



1076 Raintree Grey  2,5 cm

*Available in Taralay Impression **hop**

Taralay Multilayered

Taralay Impression / Taralay Impression **hop**

 Compact
  Acoustic
 19 dB
  Protectsol® 2
  100% recyclable



1055 Nature Oak Clear

Nature Oak



1055 Nature Oak Clear   16,6 cm 



1053 Nature Oak Blond   16,6 cm 

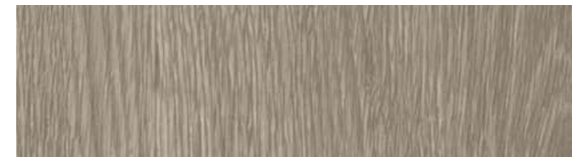

1056 Nature Oak Dark   16,6 cm 



1054 Nature Oak Brown   16,6 cm 

Noma



0519 Noma Beige   16,6 cm 



0373 Noma Ice   16,6 cm 

*Available in Taralay Impression **hop**



1093 Charme Kraft

Charme



1093 Charme Kraft   20 cm 



0723 Charme Pecan   20 cm 

Walnut



1314 Walnut Brown   10 cm 



0760 Moon Island

Moon Island

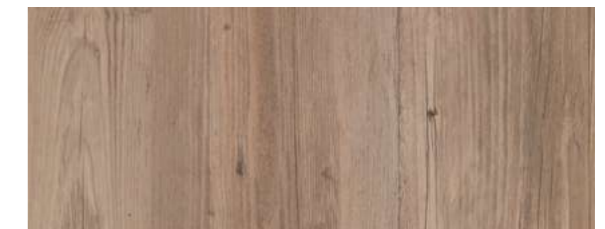

0760 Moon Island   16,6 cm 

*Available in Taralay Impression **hop**

Taralay Multilayered

Taralay Impression / Taralay Impression **hop**

 Compact
  Acoustic
 19 dB
  Protectsol® 2
  100% recyclable



0725 Sycamore Light Brown

Sycamore



0725 Sycamore Light Brown



No plank
Continuous design



0727 Sycamore Vanilla



No plank
Continuous design



0773 Portobello

Portobello



0773 Portobello



16,6 cm



0720 Infinity Aube

Infinity



0680 Infinity Greige



No plank
Continuous design



0720 Infinity Aube



No plank
Continuous design

*Available in Taralay Impression **hop**

Taralay Multilayered

Taralay Impression / Taralay Impression **hop**

 Compact
  Acoustic
 19 dB
  Protectsol® 2
  100% recyclable



Cemento

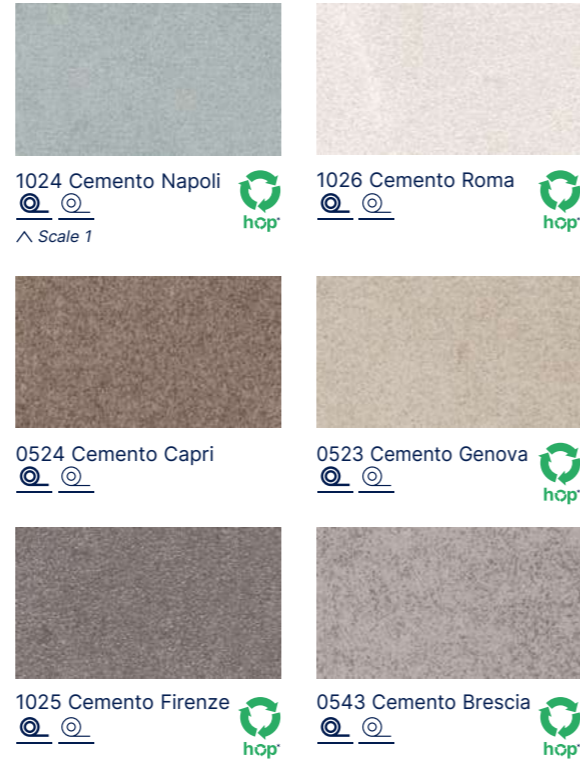

Rough

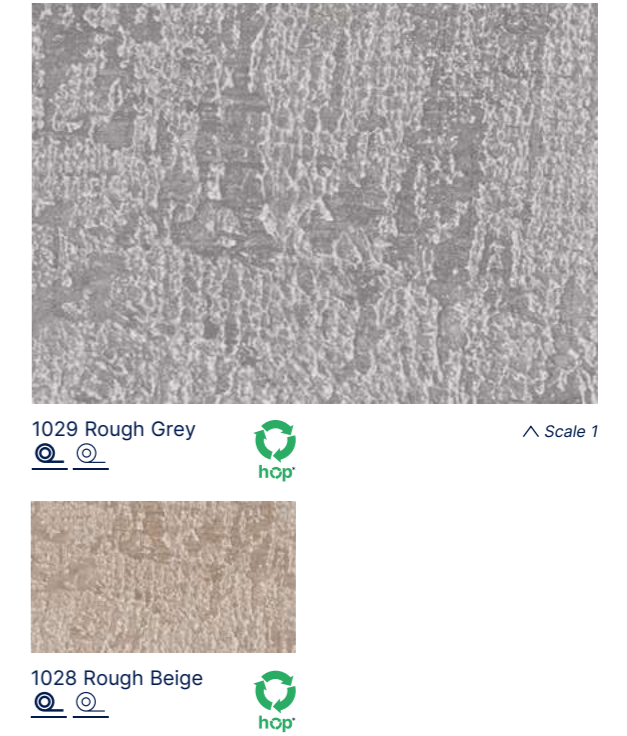

Terrazzo



Riverside



*Available in Taralay Impression **hop**

Taralay Multilayered

Taralay Impression / Taralay Impression **hop**

 Compact
  Acoustic
 19 dB
  Protectsol® 2
  100% recyclable



Gentlemen



1068 Gentlemen Denim 



1067 Gentlemen Black & White 



0770 Gentlemen Clear  



Pure Wool



1072 Pure Wool Grey 



1071 Pure Wool Taupe 

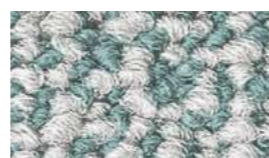

1074 Pure Wool Teal 



1073 Pure Wool Beige 

*Available in Taralay Impression **hop**



1063 Finesse Brown 



1064 Finesse Nature  



1065 Finesse Paille 



1066 Finesse Poudre 

*Available in Taralay Impression **hop**

Taralay Multilayered

Taralay Impression / Taralay Impression **hop**

 Compact
  Acoustic
 19 dB
  Protectsol® 2
  100% recyclable



Envol



1099 Envol Forest   Scale 1
 Digital print



1098 Envol Black & White  Digital print



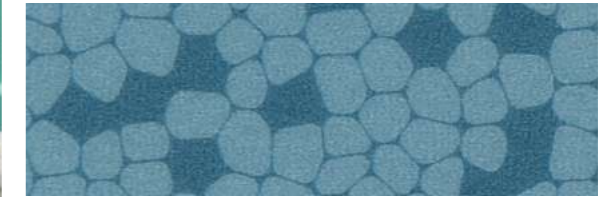

Nido



1037 Nido Teal  Scale 1
 





1036 Nido Brick  



1062 Nido Beige  



1035 Nido Grey  





Jungle



1039 Jungle Green  Scale 1
 



1038 Jungle Copper  



1040 Jungle Grey  

*Available in Taralay Impression **hop**



Rice



0736 Rice Champa  Scale 1
 



0763 Rice Greige  



0737 Rice Souris  

Taralay Multilayered

Taralay Impression



19 dB

Protecsol® 2



100% recyclable



Kubes

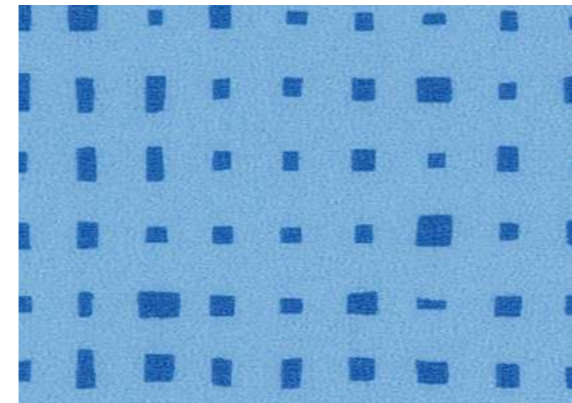

1050 Kubes Indigo



^ Scale 1

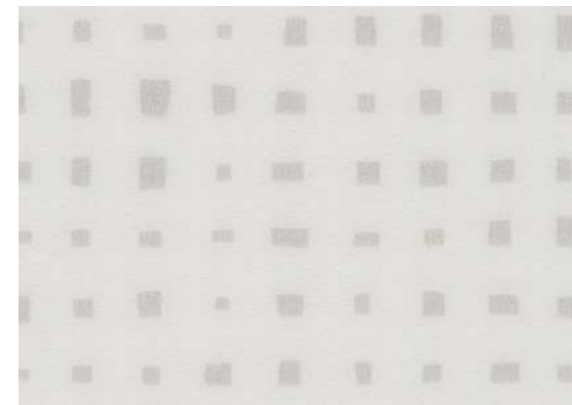

0755 Kubes White



^ Scale 1



1030 Kubes Fuschia



1031 Kubes Carmine



1047 Kubes Lemon



1027 Kubes Corail



1046 Kubes Anis



Flipkube

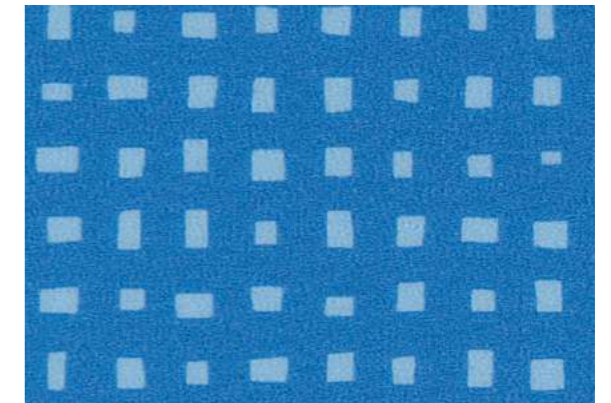

1042 Flipkube Indigo



^ Scale 1



1045 Flipkube White



^ Scale 1



1044 Flipkube Lagoon



1075 Flipkube Purple



1043 Flipkube Garden



Taralay Multilayered

Taralay Impression / Taralay Impression **hop**

 Compact
  Acoustic
 19 dB
  Protectsol® 2
  100% recyclable



Metallic



1048 Metallic Gold

^ Scale 1

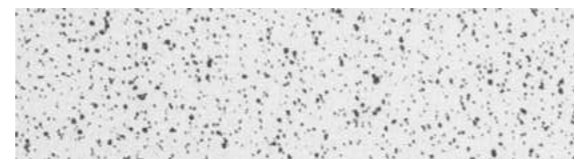

1049 Metallic Silver



Nest

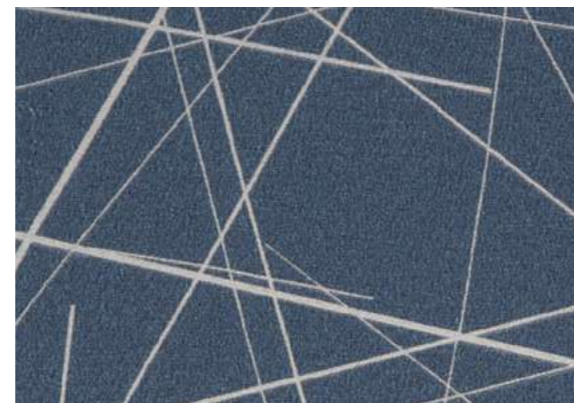

1051 Nest Blue

^ Scale 1

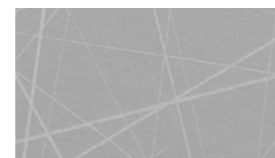

0745 Nest Metal



1052 Nest White



*Available in Taralay Impression **hop**



Chess Black & White



1041 Chess Black & White

^ Scale 10%



25x25 cm

Taralay Multilayered

Taralay Impression

 Compact
  Acoustic
 19 dB
  Protecsol® 2
  100% recyclable





Happy Number



1102 Happy Number Blue
  ^ Scale 5%
 Digital print



1103 Happy Number Grey
  ^ Scale 5%
 Digital print



Happy Form



1101 Happy Form
  ^ Scale 5%
 Digital print



Happy Road



0923 Happy Road
  ^ Scale 10%
 Digital print

Taralay Multilayered

Taralay Impression / Taralay Impression **hop**

 Compact
  Acoustic
 19 dB
  Protocolsol® 2
  100% recyclable



1092 Uni Matt Light Beige / 1103 Happy Number Grey



1084 Uni Matt Jungle Grey
 

^ Scale 1



0832 Uni Matt Grey
 

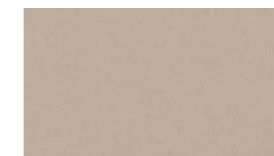

1088 Uni Matt Dark Beige
 

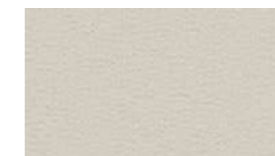

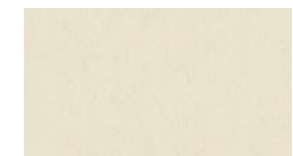

1092 Uni Matt Light Beige
 



0848 Uni Matt White
 



1091 Uni Matt Corail
 



1089 Uni Matt Copper
 



1090 Uni Matt Brick
 



1086 Uni Matt Poudre
 



1087 Uni Matt Yellow
 



1082 Uni Matt Light Green
 



1081 Uni Matt Lagoon
 



1078 Uni Matt Indigo
 

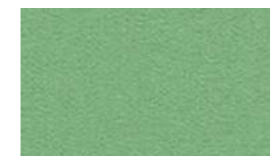

1080 Uni Matt Green
 



1079 Uni Matt Dark Green
 



1085 Uni Matt Teal
 



1083 Uni Matt Navy
 

*Available in Taralay Impression **hop**

Taralay Multilayered

My Taralay Impression

Beyond the norm

As you are unique and each of your projects represents a new challenge, Gerflor gives you the chance to stand out, from 200 sqm.

One atmosphere, one style, one floor, but several possibilities...

3 possibilities

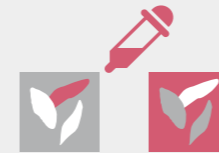

1 - COLOUR

the possibility to recolour 32 designs in the Taralay Impression range as you wish



1

Select a design* from the Taralay Impression range

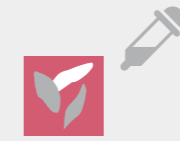

2

Change the colour scheme as you wish

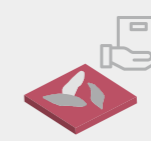

3

Receive your floor sample within 10 days of acceptance of your inquiry by Gerflor



4

Receive and install your customised flooring; delivery lead time: 6 weeks from receipt of your order

* from among 32 eligible designs (see Brochure My Taralay Impression)

"ENVOL" DESIGN
STANDARD COLOUR SCHEME



CUSTOMISED COLOUR 1



CUSTOMISED COLOUR 2



Minimum order: 50 m² (special pricing system)

If you have any questions (pricing, feasibility, technical information), do not hesitate to contact your sales representative

Taralay Multilayered

My Taralay Impression



2 - COLLECTION

the possibility to select from among **50 exclusive designs**

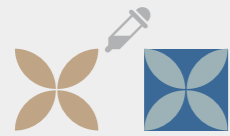

1

Draw inspiration from Gerflor's 50 exclusive designs and change, if you so wish, the design's colour scheme on www.myfloorbygerflor.com



2

View your customised design on your computer screen before approving it

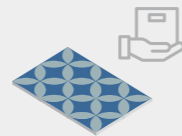

3

Receive your floor sample within 10 days of acceptance of your inquiry by Gerflor

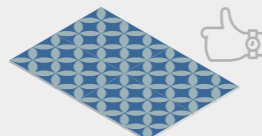

4

Receive and install your customised flooring; delivery lead time: 6 weeks from receipt of your order



3 - CUSTOMISATION

the possibility to make your floor unique



1

Send us your own file in accordance with the process described in our **specifications**



2

Approval by our technical team

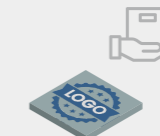

3

Receive your floor sample within 10 days and before all of your floor is made

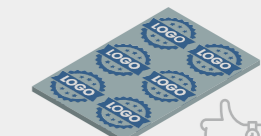

4

Receive and install your customised flooring; delivery lead time: 6 weeks from receipt of your order



File formats accepted



Files free from copyright only



300 DPI resolution



RAL, Pantone and NCS colour reference



To enhance the visual identity of your company or that of your clients, you can have your logo printed across the width of the roll.

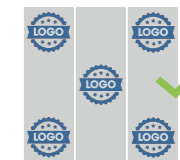

- No metallic ink
- No printing on a plain background
- Design only across the width (2 m)
- No continuity of designs over several rolls



Taralay Multilayered

Taralay Initial New

Taralay Initial Compact

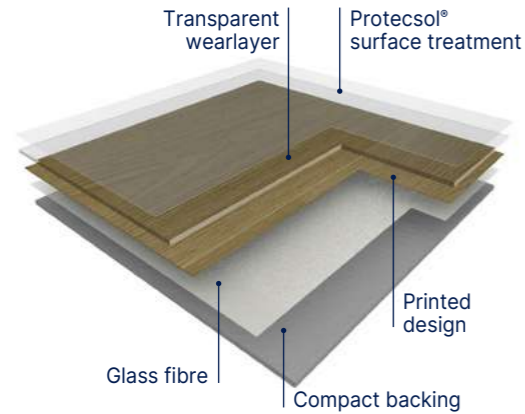

TARALAY INITIAL COMPACT is a multi-layered vinyl floorcovering, available in 2 m wide sheet, with a group T wear rating.

The product comprises a compacted backing reinforced with a glass fibre and a printed design that is protected by a transparent wear layer (0.70 mm thick). It offers 6 dB sound insulation and an indentation resistance of 0.03 mm.

It is treated with **ProtecSol®**, a UV cured surface treatment, which facilitates ease of maintenance and eliminates permanently the need for acrylic emulsion (metallisation).

According to ISO 21702, **TARALAY INITIAL COMPACT** has **anti-viral activity** against Human Coronaviruses: it reduces the number of virus by 99.3% after 2h.

According to ISO 22196, **TARALAY INITIAL COMPACT** has **anti-bacterial activity** against E. coli, S. aureus and MRSA of 99% after 24h.

These products do not contain any heavy metals or CMR 1&2 and are 100% compliant with REACH. The products emission rate of volatile organic compounds is < 10 microgram/m³ (TVOC after 28 days – ISO 16000-6).

It is 100% recyclable.

Taralay Initial Acoustic

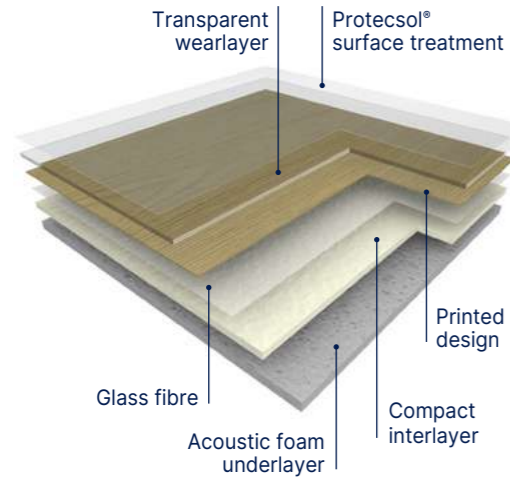

TARALAY INITIAL ACOUSTIC is an acoustic multi-layered vinyl floorcovering, available in 2 m wide sheet, with a group T wear rating.

The product comprises a foam backing reinforced with a glass fibre and a printed design that is protected by a transparent wear layer (0.65 mm thick). It offers **19 dB** sound insulation and an indentation resistance of 0.10 mm.

It is treated with **ProtecSol®**, a UV cured surface treatment, which facilitates ease of maintenance and eliminates permanently the need for acrylic emulsion (metallisation).

According to ISO 21702, **TARALAY INITIAL ACOUSTIC** has **anti-viral activity** against Human Coronaviruses: it reduces the number of virus by 99.3% after 2h.

According to ISO 22196, **TARALAY INITIAL ACOUSTIC** has **anti-bacterial activity** against E. coli, S. aureus and MRSA of 99% after 24h.

It does not contain any heavy metals or CMR 1&2 and is 100% compliant with REACH. The products emission rate of volatile organic compounds is < 10 microgram/m³ (TVOC after 28 days – ISO 16000-6).

It is 100% recyclable.



- All references are available in **Compact** and **Acoustic**
- High resistance to indentation **0.03 mm (Compact)** and **0.10 mm (Acoustic)**
- High impact insulation **6 dB (Compact)** and **19 dB (Acoustic)**
- **ProtecSol®** Surface Treatment (easy maintenance & no wax)
- Highest performance in **TVOC emission < 10 microgram/m³**

			Taralay Initial Compact Pro	Taralay Initial Acoustic Pro
Description				
Total thickness	EN ISO 24346	mm	2.00	3.35
Thickness of wearlayer	EN ISO 24340	mm	0.70	0.65
Weight	EN ISO 23997	g/sqm	2635	2825
Width of sheet	EN ISO 24341	cm	200	200
Length of sheet	EN ISO 24341	lm	25	25
Phthalate free	-	-	OK	OK
Classification				
Norm / Product specification	-	-	EN ISO 10582	EN ISO 11638
European classification	EN ISO 10874	class	34-43	34-42
Fire rating	EN 13501-1	class	Bfl-s1	Bfl-s1
Static electrical propensity	EN 1815	kV	< 2	< 2
Slip resistance wet	EN 16165:2021 – Appendix B (DIN 51 130)	class	R10	R10
Performances				
Wear resistance	EN 660.2	mm ³	≤ 2.0	≤ 2.0
Wear group	-	group	T	T
Type Binder content	EN ISO 10582	type	I	-
Dimensional stability	EN ISO 23999	%	≤ 0.40	≤ 0.40
Residual indentation (requirement)	EN ISO 24343-1	mm	≤ 0.10	≤ 0.20
Residual indentation (average measured value)	-	mm	≈ 0.03	≈ 0.10
Impact sound insulation	EN ISO 717-2	dB	6	19
Castor chair test (type H)	ISO 4918	-	OK	OK
Thermal conductivity	EN ISO 10456	W/(m.k)	0.25	0.25
Colour fastness	EN ISO 105-B02	degree	≥ 6	≥ 6
Surface treatment	-	-	ProtecSol®	ProtecSol®
Chemical products resistance	EN ISO 26987	-	OK	OK
Environment				
Recycled content (average)	-	%	14	17
Recyclability	-	%	100	100
EPD	-	-	Available	Available
Health				
TVOC after 28 days	ISO 16000-6	microgram/m ³	< 10	< 10
Certification	-	-	Floorscore®	Floorscore®
Anti-bacterial activity (E. coli - S. aureus - MRSA) ⁽¹⁾	ISO 22196	-	> 99% inhibits growth	> 99% inhibits growth
Anti-viral activity (human coronavirus) after 2h ⁽¹⁾	ISO 21702	-	> 99.3% virucidal activity	> 99.3% virucidal activity
CE marking				



EN 14041



(1) The implementation of an effective cleaning regime is the most important defence against infection.

Taralay Multilayered

Taralay Initial **New**



 19 dB **Protectsol®**

 100% recyclable



Chicago



1242 Chicago Sage



^ Scale 1



1279 Chicago Mint



1245 Chicago Haze



1249 Chicago Storm



1278 - Chicago Sunshine



1244 - Chicago Cream



1247 Chicago Sand



1281 Chicago Coral



1243 Chicago Terra



1248 Chicago Sirocco



1280 Chicago Sky

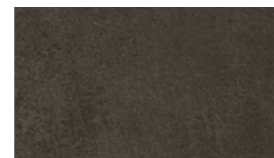

1246 Chicago Hurricane



1250 Chicago Typhoon



1282 Chicago Ocean



1254 Cottage Clear /
1242 Chicago Sage /
1260 Terrazzo Sage



1283 Fiesta Rainbow

Fiesta Rainbow



1283 Fiesta Rainbow



^ Scale 50%



1261 Terrazzo Terra - 1238 Azay Cream

Terrazzo

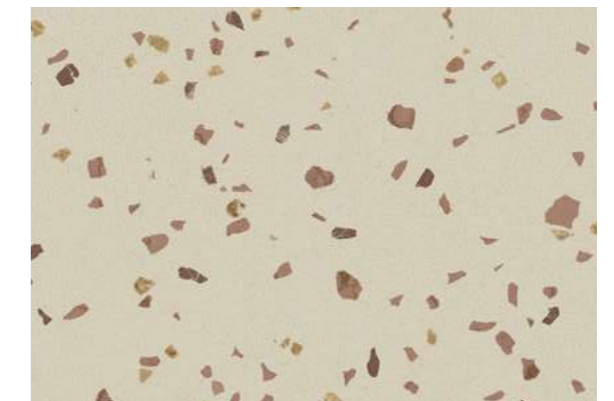

1261 Terrazzo Terra



^ Scale 1



1260 Terrazzo Sage



Taralay Multilayered

Taralay Initial **New**

 Compact
  Acoustic
 19 dB
  Protectsol®
  100% recyclable



Cordoba Black & White



2226 Cordoba Black & White
 

^ Scale 15%

Verone Navona



1263 Verone Navona
 

^ Scale 1

Filament



1256 Filament Golden
 

No plank
Continuous design

0799 Filament Light
 

No plank
Continuous design

0271 Filament Alto
 

No plank
Continuous design

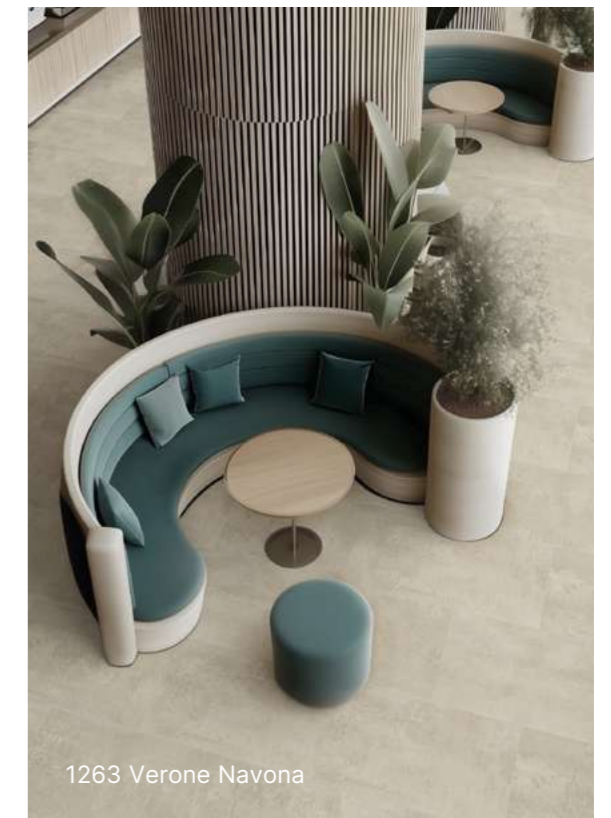

Valencay



1442 Valencay Pecan
 

16,6 cm



0179 Valencay Patine
 

16,6 cm





0368 Valencay Blond
 

16,6 cm





Bali

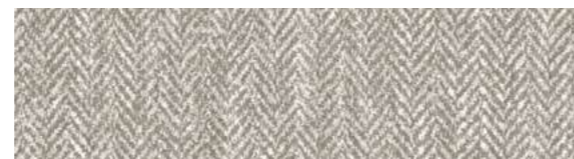

1239 Bali Beige
 

^ Scale 1



1240 Bali Gris
 

Taralay Multilayered

Taralay Initial **New**



 19 dB **Protecsol®**

 100% recyclable



1238 Azay Cream

Esterel



0636 Esterel Blond

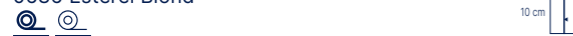

10 cm



1255 Esterel Clear



10 cm

Azay

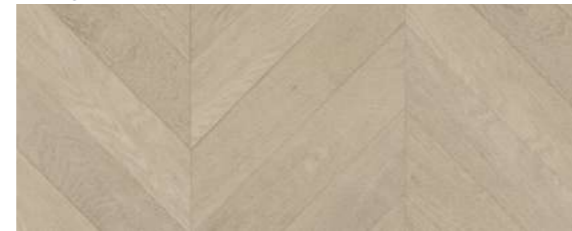

1238 Azay Cream



75x35 cm



1271 Azay Gold



75x35 cm

Moon Island



0760 Moon Island



16,6 cm

Habana 3D



0797 Habana 3D Ivory



16,6 cm



0828 Habana 3D Beige



16,6 cm

Cottage



1252 Cottage Brown



20 cm



1253 Cottage Cinnamon



20 cm



1251 Cottage Blond



20 cm



1254 Cottage Clear



20 cm



1252 Cottage Brown

Bostonian



0961 Bostonian Honey



20 cm



1241 Bostonian Chatain



20 cm

Pattern repeat Taralay Initial

Colour Reference	Colour Name	Pattern Repeat		Drawing dimension
		Width	Length	
1238	Azay Cream	1000x1000	75 x 350	
1271	Azay Gold	1000x1000	75 x 350	
1239	Bali Beige	1000x1000	all-over	
1240	Bali Gris	1000x1000	all-over	
1241	Bostonian Chatain	1000x1000	200 x 1000	
0961	Bostonian Honey	1000x1000	200 x 1000	
1281	Chicago Coral	1000x1000	all-over	
1244	Chicago Cream	1000x1000	all-over	
1245	Chicago Haze	1000x1000	all-over	
1246	Chicago Hurricane	1000x1000	all-over	
1279	Chicago Mint	1000x1000	all-over	
1282	Chicago Ocean	1000x1000	all-over	
1242	Chicago Sage	1000x1000	all-over	
1247	Chicago Sand	1000x1000	all-over	
1248	Chicago Sirocco	1000x1000	all-over	
1280	Chicago Sky	1000x1000	all-over	
1249	Chicago Storm	1000x1000	all-over	
1278	Chicago Sunshine	1000x1000	all-over	
1243	Chicago Terra	1000x1000	all-over	
1250	Chicago Typhoon	1000x1000	all-over	
2226	Cordoba Black & White	1000x1000	250 x 250	
1251	Cottage Blond	1000x1000	200 x 1000	
1252	Cottage Brown	1000x1000	200 x 1000	
1253	Cottage Cinnamon	1000x1000	200 x 1000	
1254	Cottage Clear	1000x1000	200 x 1000	
0636	Esterel Blond	1000x1000	100 x 1000	
1255	Esterel Clear	1000x1000	100 x 1000	
1283	Fiesta Rainbow	1000x1000	all-over	
0271	Filament Alto	1000x1000	all-over	
1256	Filament Golden	1000x1000	all-over	
0799	Filament Light	1000x1000	all-over	
0828	Habana 3D Beige	1000x1000	166 x 1000	
0797	Habana 3D Ivory	1000x1000	166 x 1000	
0760	Moon Island	1000x1000	166 x 1000	
1260	Terrazzo Sage	1000x1000	all-over	
1261	Terrazzo Terra	1000x1000	all-over	
1704	Valencay Blond	1000x1000	166 x 1000	
0179	Valencay Patine	1000x1000	166 x 1000	
1262	Valencay Pecan	1000x1000	166 x 1000	
1263	Verone Navona	1000x1000	333 x 500	

European Creation Tiles & Planks
manufacturer since 1985

- 7 Tiles & Planks factories
including 5 in Europe
- Stock in Europe
12 logistics hubs
- Internal Design Center
> exclusive designs

The Reference in Tiles & Planks

Creation Tiles & Planks

pages 104-183

- 108. **Creation 30/40/55/70 Dry Back** **New**
Creation 40/55/70 Clic **New**
Creation 40/55 Clic Acoustic **New**
- 134. **Creation 55 Looselay /**
Looselay Acoustic
Creation 70 Looselay
- 150. **Creation Saga²**
- 156. **Creation 70 Connect**
- 160. **Creation 70 Megaclitc** **New**
- 168. **Creation 40 /55/70 Zen**
- 178. **My Creation**
My Creation Zen
My Saga
- 180. **Technical data**

Creation Tiles & Planks

Full technical data sheet pages 180/183

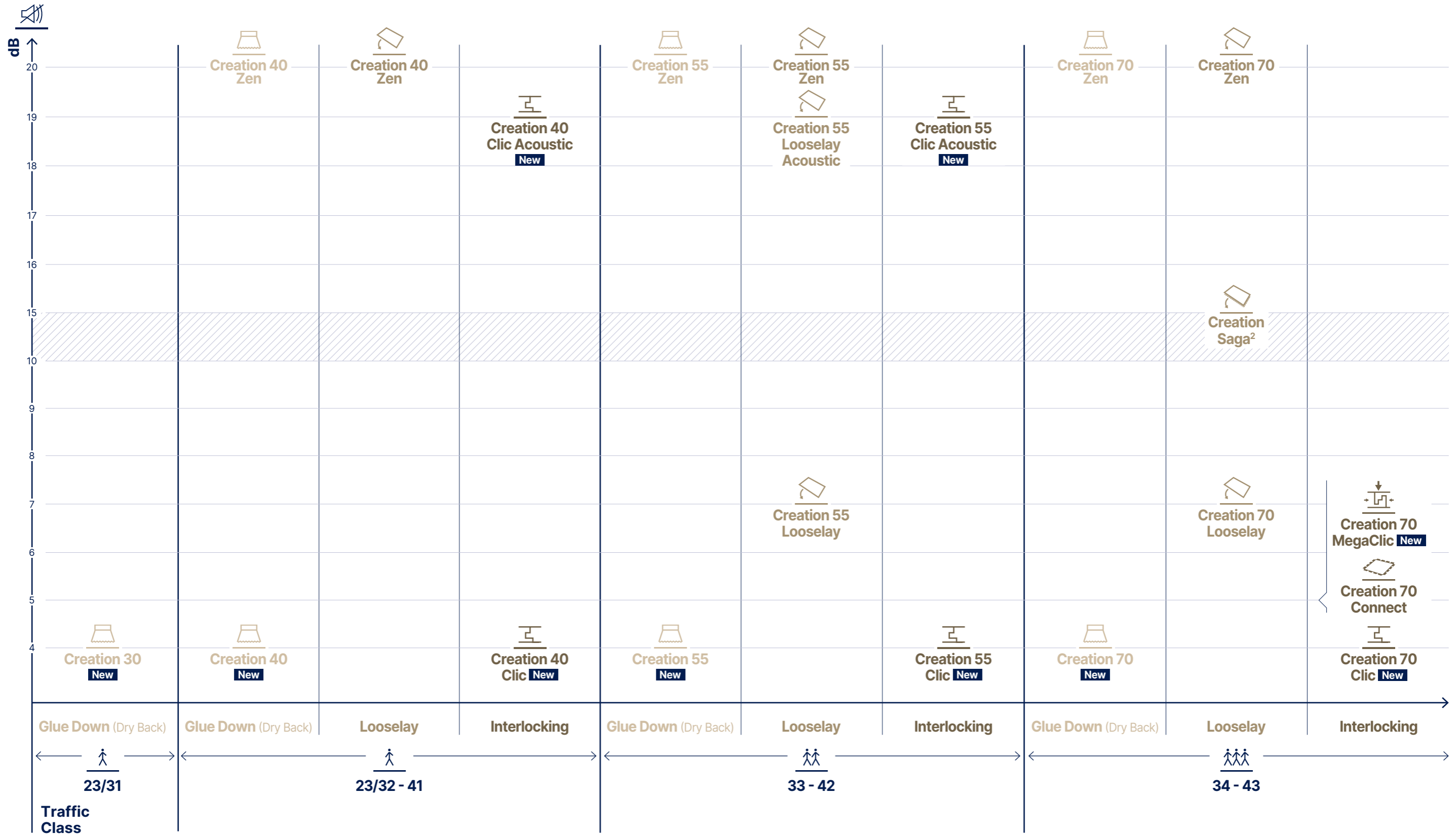

Creation Tiles & Planks

Simulator Visualize your design in any room setting on gerflor.com > Services > Interior Designer

Create without limits

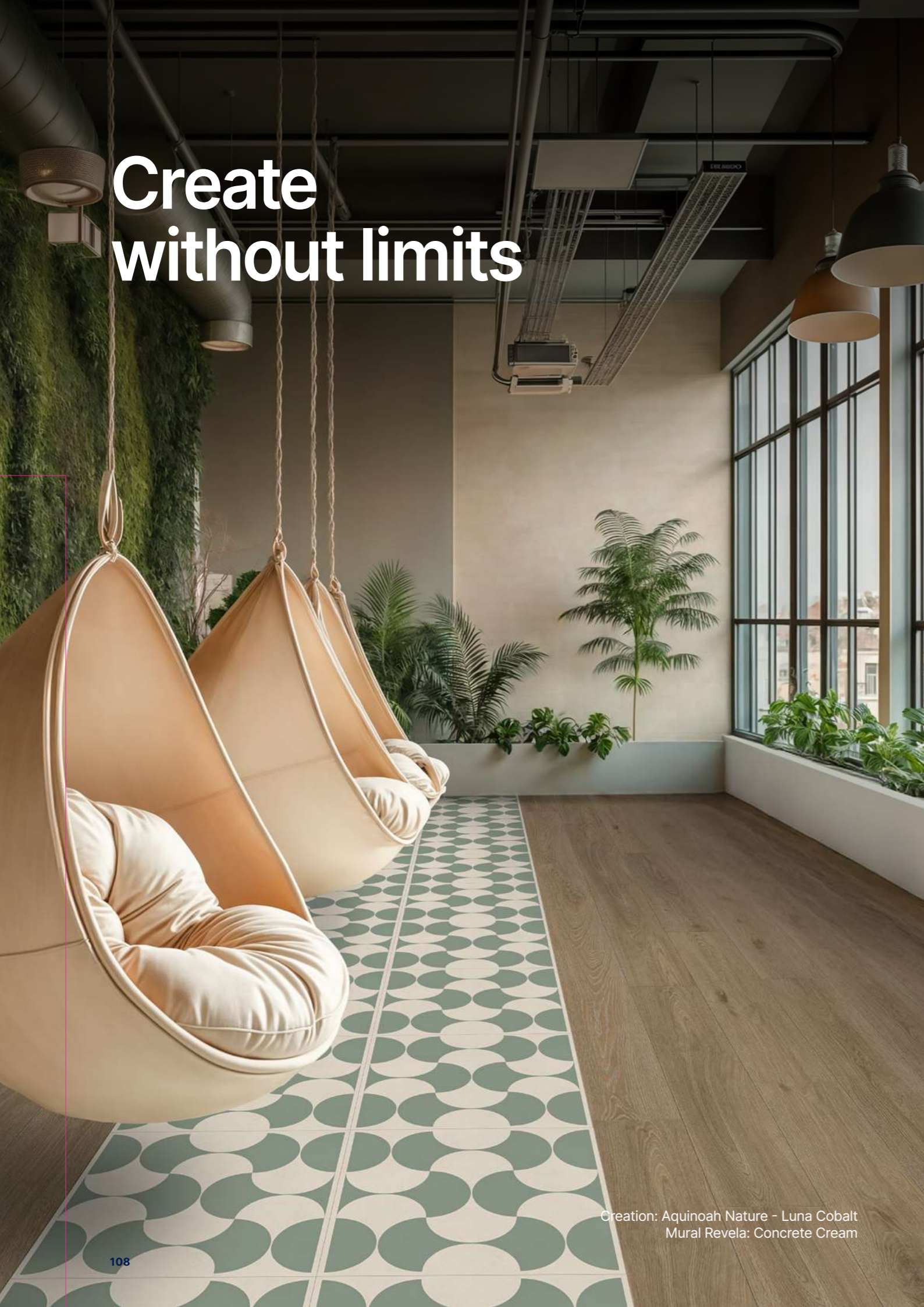

Creation: Aquinoah Nature - Luna Cobalt
Mural Revela: Concrete Cream



New Collection Creation 30/40/55/70

85 colors

12 formats

100% coordinated

Inspired by the latest interior design trends, a collection with **shades and woodgrains carefully selected for perfect harmony.**

Ultra-natural look & feel

Textures inspired by raw materials, with authentic, ultra-realistic finishing touches.

Acoustic & thermal comfort

Reduced footstep sounds, improved insulation, and a constant pleasant temperature assured.

Harmony: from floor to wall

Creation & Revela Wall: endless possibilities to reach perfect harmony.

Our collections are designed for easy mix and match.

All your needs in one Collection

Available for every application and traffic requirement, for new built or renovation, with or without acoustic.



Creation: Bloom Uni Cream
Mural Revela: Concrete Cream

Creation Tiles & Planks

Creation 30/40/55/70 - Dry Back / Clic / Clic Acoustic
Unique construction to maximize comfort



① Exclusive ProtecShield™ surface treatment

- Long-lasting Protection
- Ease of maintenance
- Durable Matte finish



② Smart design

Expanded design variation for minimized repetition (Doubled pattern design)



③ Acoustic Top Layer

- Acoustic Comfort (in the room)
- Thermal Comfort
- Walking Comfort



④ Rigid Core

(Creation Clic & Clic Acoustic)

- Effortless Installation
- User-Friendly Installation
- Durability



⑤ Acoustic back Layer

(Creation Acoustic & Clic Acoustic)

- Acoustic Comfort (in the room)
- Walking Comfort



Creation 30 / 40 / 55 / 70 Dry Back

CREATION DRY BACK is a synthetic, decorative, and flexible PVC flooring solution, available in planks and tiles with four-sided beveled edges. It features a 0,70 mm wear-layer in CREATION 70, 0,55 mm in CREATION 55, 0,40 mm in CREATION 40, and 0,30 mm in CREATION 30. It has a high definition printed decorative film, offering an extensive design variety. The product also includes an acoustic top layer for enhanced walking comfort, along with a resilient core that facilitates easy cutting during installation.

With a total thickness of 2,5mm in CREATION 70 / 55, 2 mm in CREATION 40/30,

It benefits from a crosslinked polyurethane surface treatment (**Protecshield™**), which ensures easy maintenance and improved resistance to micro-scratches.

CREATION DRY BACK is designed for glue-down installation. It is classified as Bfl-s1 according to EN 13501-1 fire safety standard.

It meets the following European usage classification: 34/43 in CREATION 70, 33/42 in CREATION 55, 23/32-41 in CREATION 40, and 23/31 in CREATION 30.

CREATION DRY BACK is free from phthalates (except for recycled content) and is 100% recyclable. Installation offcuts and end-of-life material, under certain conditions, can be collected and recycled through Gerflor's "Second Life" program. The product contains an average of 35% recycled content and complies with REACH regulations. Its indoor air quality performance is excellent, with TVOC emissions after 28 days (NF EN 16000) below 10 µg/m³, earning an A+ rating - the highest level under health labeling standards, Floorscore®, IAC Gold & M1.

Creation 40 / 55 / 70 Clic

CREATION CLIC is a decorative, flexible flooring solution, classified in abrasion group T, available in planks and tiles with four-sided beveled edges.

It features a 0,70 mm wear-layer in CREATION 70 CLIC, 0,55 mm in CREATION 55 CLIC and 0,40 mm in CREATION 40 CLIC. It has a high definition printed decorative film, offering an extensive design variety.

The product also includes an acoustic top layer for improved walking comfort and easier cutting during installation and a rigid core, which allows installation over existing subfloors, making it suitable for renovation projects.

The total thickness is 5mm in CREATION 55/70 CLIC and 4,5 mm in CREATION 40 CLIC;

It benefits from a cross-linked polyurethane surface treatment (**Protecshield™**), which facilitates maintenance and provides resistance to micro-scratches.

CREATION CLIC is quick and easy to install thanks to its Gerflor Fold Down clic system: vertical locking on the short side and horizontal locking on the long side.

It is classified Bfl-s1 according to the fire standard EN 13501-1. It meets the following European usage classification: 34/43 in CREATION 70 CLIC, 33/42 in CREATION 55 CLIC and 23/32-41 in CREATION 40 CLIC.

CREATION CLIC is phthalate-free (except for recycled content) and 100% recyclable. Installation offcuts and end-of-life flooring (under certain conditions) can be collected and recycled through the Gerflor "Second Life" program.

It contains an average of 33% recycled content, certified by SCS Global Services (except Creation 70 Clic and Creation 55 Clic Acoustic HB). It complies with REACH regulations. TVOC emissions at 28 days (NF EN 16000) are < 10 µg/m³, rated A+ (the highest rating), and certified Floorscore® and M1.

CREATION CLIC has an individual Environmental Product Declaration (EPD), verified and certified by UL Certification.

Creation 40 / 55 Clic Acoustic

CREATION CLIC ACOUSTIC is a decorative, flexible flooring solution, classified in abrasion group T, available in planks and tiles with four-sided beveled edges. It features a 0,55mm wear layer and a 2m high definition printed decorative film, offering maximum design variety.

The product also includes a double acoustic layer:
- An acoustic top layer for improved walking comfort and easier cutting during installation.
- An acoustic back layer to enhance sound insulation (19 dB).

Between these two layers is a rigid core, which allows installation over existing subfloors, making it suitable for renovation projects. The total thickness is 6mm.

It benefits from a cross-linked polyurethane surface treatment (**Protecshield™**), which facilitates maintenance and provides resistance to micro-scratches.

CREATION CLIC ACOUSTIC is quick and easy to install thanks to its Gerflor Fold Down clic system: vertical locking on the short side and horizontal locking on the long side.

It is classified Bfl-s1 according to the fire standard EN 13501-1. It meets the following European usage classification: 33/42 in CREATION 55 CLIC ACOUSTIC and 23/32-41 in CREATION 40 CLIC ACOUSTIC.

CREATION CLIC ACOUSTIC is phthalate-free (except for recycled content) and 100% recyclable. Installation offcuts and end-of-life flooring (under certain conditions) can be collected and recycled through the Gerflor "Second Life" program.

It contains an average of 33% recycled content, certified by SCS Global Services. It complies with REACH regulations. TVOC emissions at 28 days (NF EN 16000) are < 10 µg/m³, rated A+ (the highest rating), and certified Floorscore® and M1.

CREATION CLIC ACOUSTIC has an individual Environmental Product Declaration (EPD), verified and certified by UL Certification.

Creation Tiles & Planks

Creation 30/40/55/70 - Dry Back / Clic / Clic Acoustic

From floor to wall

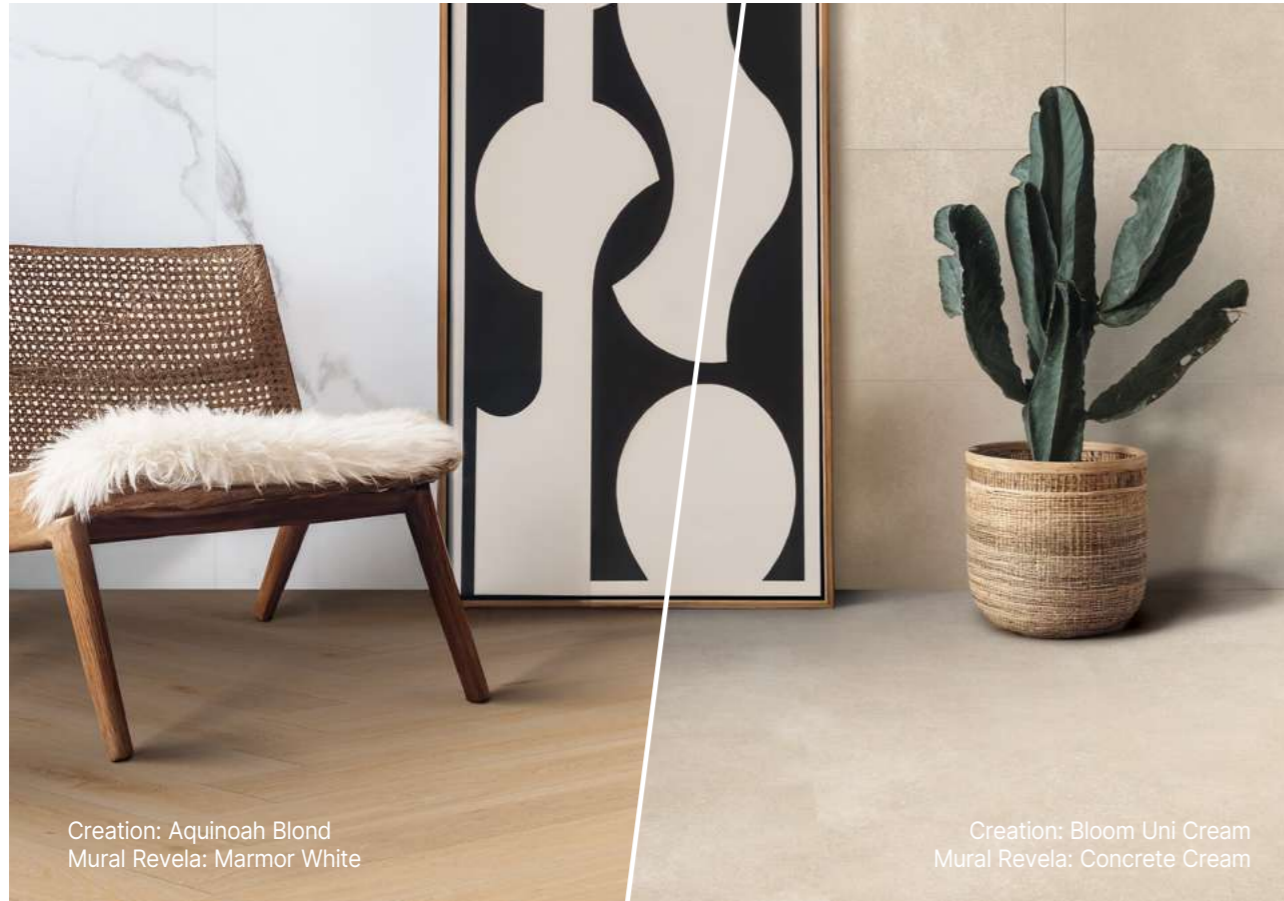

Creation: Aquinoah Blond
Mural Revela: Marmor White

Creation: Bloom Uni Cream
Mural Revela: Concrete Cream

Perfect harmony between Creation & Mural Revela

7 matching designs Creation & Mural Revela

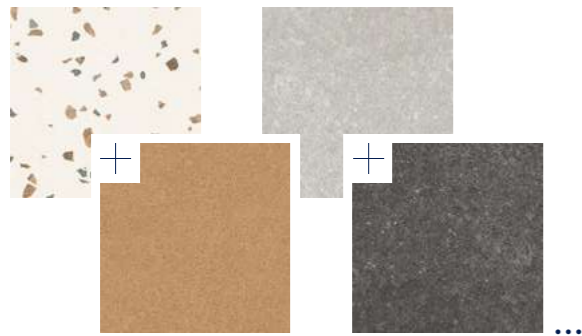

Creation
1745 Confetti Cobalt
Mural Revela
Terrazzo Cobalt

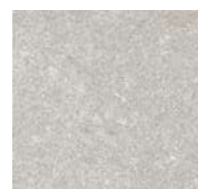

Creation
1599 Bloom Uni Clear
Mural Revela
Concrete Clear

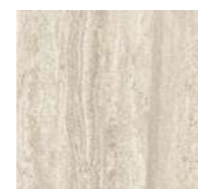

Creation
1729 Paradiso Bone
Mural Revela
Travertine Bone

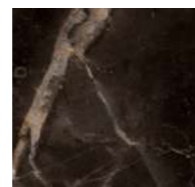

Creation
1742 Sahara Noir
Mural Revela
Marbre Noir

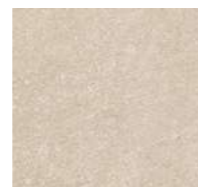

Creation
1600 Bloom Uni Cream
Mural Revela
Concrete Cream



Creation
1701 Linear Wood Clear
Mural Revela
Wood Clear

Full Mural Revela
collection page 198
and on gerflor.com

Ultra Natural Look & Feel

More than 60% of our collection is using our new emboss technology - designed by our Artistic Team.



NEW

Scandinavian

A delicate surface, with a linear grain that accentuates the orientation of the material.



NEW

Authentic

Highlighting the wood's cathedral grain for a tactile realism.



Brushed

The sensory expression of rustic wood, with a structured and random surface.



Lounge Oak & Charming Oak

The registered surface perfectly follows the grain patterns for visual and tactile consistency.



Stone

A surface with a fine and uniform texture, evoking the subtle softness of the polished stone or concrete.



Hammered

A surface with a slightly grainy feel, where subtle irregularities evoke the authenticity of stone.



In addition to these ultra realistic embossing, Protecshield™ surface treatment offers a velvet touch, with a matt surface, ease of maintenance and micro scratch resistance.

Creation Tiles & Planks

Creation 30/40/55 - Dry Back / Clic / Clic Acoustic

Formats details on page 132



Tamo



1598 Tamo Cream Dry Back: 30 / 40 / 55
Clic Ac: 40 / 55



1561 Tamo Natural Dry Back: 30 / 40 / 55
Clic Ac: 40 / 55



1567 Tamo Clear Dry Back: 30 / 40 / 55
Clic Ac: 40 / 55



1568 Tamo Light Brown Dry Back: 30 / 40 / 55
Clic Ac: 40 / 55

Lounge Oak



1272 Lounge Oak Beige Dry Back: 30 / 40 / 55
Clic: 40 / 55
Clic Ac: 40 / 55



1273 Lounge Oak Natural Dry Back: 30 / 40 / 55
Clic: 40 / 55
Clic Ac: 40 / 55



1271 Lounge Oak Golden Dry Back: 30 / 40 / 55
Clic: 40 / 55
Clic Ac: 40 / 55



1274 Lounge Oak Chesnut Dry Back: 30 / 40 / 55
Clic: 40 / 55
Clic Ac: 40 / 55



Lounge Oak Golden

Quartet



0870 Quartet Honey Dry Back: 30 / 40 / 55
Clic: 40 / 55
Clic Ac: 40 / 55



0503 Quartet Dry Back: 30 / 40 / 55
Clic: 40 / 55
Clic Ac: 40 / 55



0545 Quartet Natural Dry Back: 30 / 40 / 55
Clic: 40 / 55
Clic Ac: 40 / 55



1597 Quartet Dark Brown Dry Back: 30 / 40 / 55
Clic: 40 / 55
Clic Ac: 40 / 55

Aquinoah



1704 Aquinoah Blond Dry Back: 30 / 55
Clic: 55
Clic Ac: 40 / 55



1706 Aquinoah Honey Dry Back: 30 / 55
Clic: 55
Clic Ac: 40 / 55



Quartet Honey



1707 Aquinoah Nature Dry Back: 30 / 55
Clic: 55
Clic Ac: 40 / 55



1705 Aquinoah Brown Dry Back: 30 / 55
Clic: 55
Clic Ac: 40 / 55

Creation Tiles & Planks

Creation 30/40/55 - Dry Back / Clic / Clic Acoustic

Formats details on page 132



Savage Oak



1708 Savage Oak Greige

Dry Back: 30 / 55
Clic Ac: 40 / 55



1709 Savage Oak Honey

Dry Back: 30 / 55
Clic: 55
Clic Ac: 40 / 55



1710 Savage Oak Smoked

Dry Back: 30 / 55
Clic: 55
Clic Ac: 55



Cedar



1605 Cedar Dark Brown

Dry Back: 30 / 40 / 55
Clic: 40 / 55
Clic Ac: 40 / 55



XL Plank

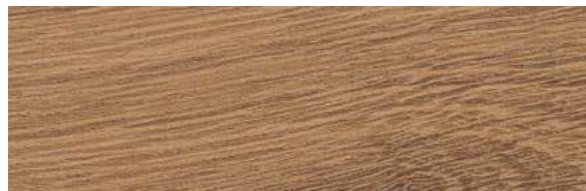

1606 Cedar Golden

Dry Back: 30 / 40 / 55
Clic: 40 / 55
Clic Ac: 40 / 55



XL Plank



0850 Cedar Brown

Dry Back: 30 / 40 / 55
Clic: 40 / 55
Clic Ac: 40 / 55



XL Plank



1607 Cedar Natural

Dry Back: 30 / 40 / 55
Clic: 40 / 55
Clic Ac: 40 / 55



XL Plank



Creation: Savage Oak Honey
Mural Revela: Liverpool



0441 Honey Oak

Dry Back: 30 / 40 / 55
Clic: 40 / 55
Clic Ac: 40 / 55



0347 Ballerina

Dry Back: 30 / 40 / 55
Clic: 40 / 55
Clic Ac: 40 / 55



0455 Long Board

Dry Back: 30 / 40 / 55
Clic: 40 / 55
Clic Ac: 40 / 55



0504 Twist

Dry Back: 30 / 40 / 55
Clic: 40 / 55
Clic Ac: 40 / 55



0584 White Lime

Dry Back: 30 / 40 / 55
Clic: 40 / 55
Clic Ac: 40 / 55



0456 Ranch

Dry Back: 30 / 40 / 55
Clic: 40 / 55
Clic Ac: 40 / 55



Honey Oak

Bostonian Oak



0851 Bostonian Oak Honey

Dry Back: 30 / 40 / 55
Clic Ac: 40 / 55



0853 Bostonian Oak Beige

Dry Back: 30 / 40 / 55
Clic Ac: 40 / 55

*Clic & Clic Acoustic for Cedar designs

116 Design shade variation: Light Medium high

Smart Design by Gerflor offers twice the design variety for a floor that always looks unique.

Creation Tiles & Planks

Creation 30/40/55 - Dry Back / Clic / Clic Acoustic

Linear Wood



1702 Linear Wood Honey Dry Back: 55



1701 Linear Wood Clear Dry Back: 55
Clic: 55
Clic Ac: 55



1703 Linear Wood Nature Dry Back: 55
Clic: 55
Clic Ac: 55



Charming Oak Emboss in register



1278 Charming Oak Beige Dry Back: 30 / 55
Clic Ac: 55



1279 Charming Oak Grey Dry Back: 30 / 55
Clic Ac: 55



1714 Charming Oak Smoked Dry Back: 30 / 55



*Clic Acoustic for Charming designs

118 Design shade variation:  Light  Medium  high

Versailles



1750 Versailles Honey Dry Back: 55



1706 Aquinoah Honey

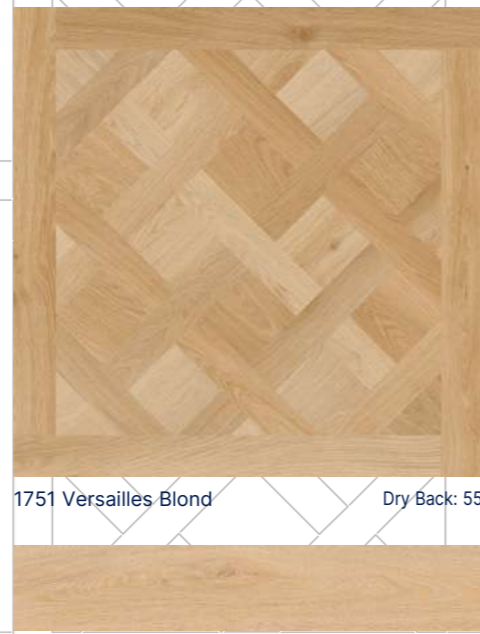

1751 Versailles Blond Dry Back: 55

1704 Aquinoah Blond



Smart Design by Gerflor offers twice the design variety for a floor that always looks unique.

 Formats details on page 132



Herringbone



1706 Aquinoah Honey



1704 Aquinoah Blond



0347 Ballerina



0504 Twist



1707 Aquinoah Nature

0503 Quartet

Hungarian Point



1706 Aquinoah Honey

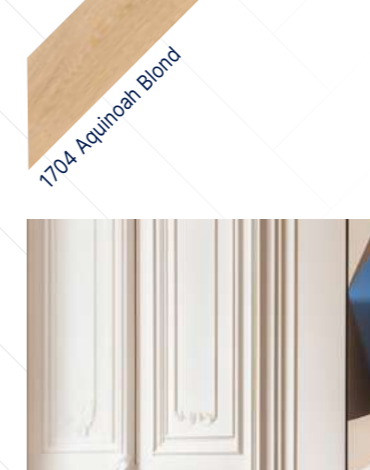

1704 Aquinoah Blond



Hungarian Point Aquinoah Blond



Herringbone Aquinoah Nature

Creation Tiles & Planks

Creation 30/40/55 - Dry Back / Clic / Clic Acoustic

Formats details on page 132



Bloom Uni

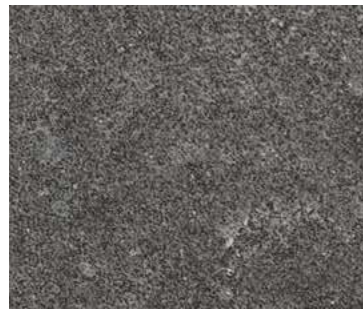

1601 Bloom Uni Dark
Dry Back: 30 / 40 / 55
Clic: 55
Clic Ac: 40 / 55

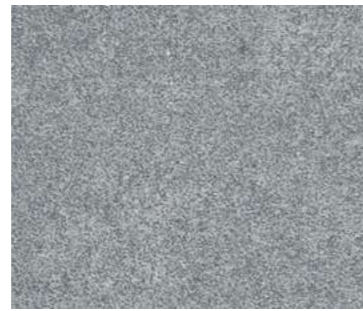

1602 Bloom Uni Pearl
Dry Back: 30 / 40 / 55
Clic: 55
Clic Ac: 40 / 55



1599 Bloom Uni Clear
Dry Back: 30 / 40 / 55
Clic: 55
Clic Ac: 40 / 55



1600 Bloom Uni Cream
Dry Back: 30 / 40 / 55
Clic Ac: 40 / 55

Curton Stone



1603 Curton Stone Clear
Dry Back: 30 / 40 / 55
Clic: 40 / 55
Clic Ac: 40 / 55



1604 Curton Stone Taupe
Dry Back: 30 / 40 / 55
Clic: 40 / 55
Clic Ac: 40 / 55



Curton Stone Taupe

Urban Street & Resin Marble

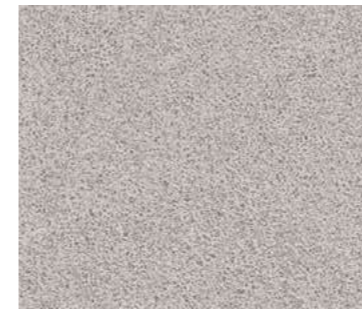

1283 Urban Street Light
Dry Back: 55
Clic Ac: 55



1284 Urban Street Medium
Dry Back: 55
Clic Ac: 55



1565 Urban Street Cream
Dry Back: 55
Clic Ac: 55



1757 Resin Marble
Dry Back: 55



Resin Marble /
Urban Street Cream

Backyard

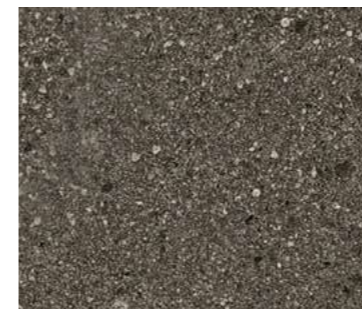

1711 Backyard Dark
Dry Back: 30 / 55
Clic Ac: 40 / 55



1713 Backyard Taupe
Dry Back: 30 / 55
Clic Ac: 40 / 55



1712 Backyard Light Beige
Dry Back: 30 / 55
Clic Ac: 40 / 55

Creation Tiles & Planks

Creation 30/40/55 - Dry Back / Clic / Clic Acoustic

Formats details on page 132



Confetti & Urban Street



1745 Confetti Cobalt
Dry Back: 55
Clic Ac: 55

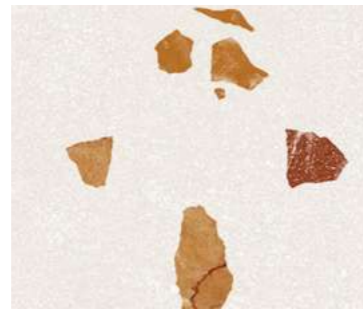

1744 Confetti Amber
Dry Back: 55
Clic Ac: 55

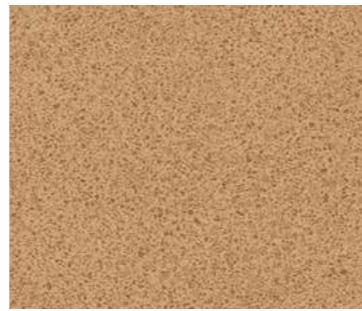

1726 Urban Street Amber
Dry Back: 55

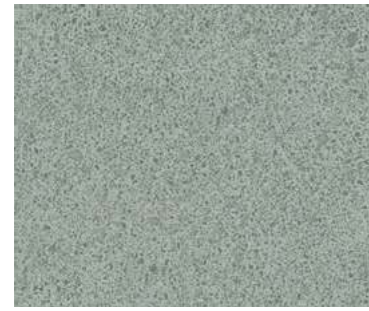

1727 Urban Street Cobalt
Dry Back: 55



Confetti Amber /
Urban Street Amber

Luna



1749 Luna Cobalt
Dry Back: 55



1748 Luna Beige
Dry Back: 55



1747 Luna Amber
Dry Back: 55

Color scan scale: 1/10

122 Design shade variation: Light Medium high

Marble & Travertin



1729 Paradiso Bone
Dry Back: 55



1730 Paradiso Cream
Dry Back: 55



Creation: Paradiso Bone
Mural Revela: Travertine Bone

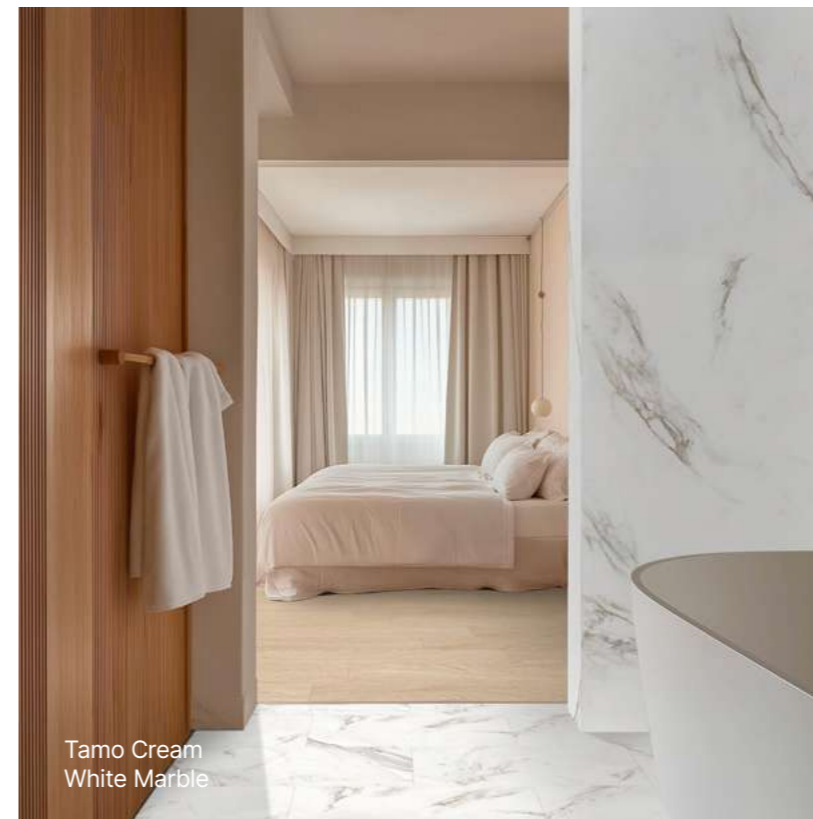

Tamo Cream
White Marble



1743 White Marble
Dry Back: 55
Clic Ac: 55

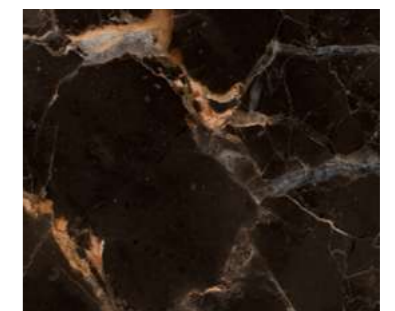

1742 Sahara Noir
Dry Back: 55

Creation Tiles & Planks

Creation 70 - Dry Back / Clic

Formats details on page 132



City Oak



1719 City Oak Honey

Dry Back



1717 City Oak Dark Brown

Dry Back Clic



1715 City Oak Beige

Dry Back Clic



City Oak Beige



1716 City Oak Brown

Dry Back



1718 City Oak Grey

Dry Back Clic



Lounge Oak



1272 Lounge Oak Beige

Dry Back Clic

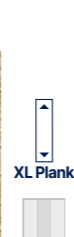

1271 Lounge Oak Golden

Dry Back Clic



1273 Lounge Oak Natural

Dry Back Clic



1274 Lounge Oak Chesnut

Dry Back Clic

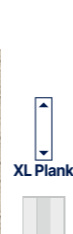

Quartet



0870 Quartet Honey

Dry Back Clic



0545 Quartet Natural

Dry Back Clic



0503 Quartet

Dry Back Clic



1597 Quartet Dark Brown

Dry Back Clic

Cedar



1605 Cedar Dark Brown

Dry Back Clic



1606 Cedar Golden

Dry Back Clic



0850 Cedar Brown

Dry Back Clic



1607 Cedar Natural

Dry Back Clic



Cedar Dark Brown

*Clic version only for Cedar design

Creation Tiles & Planks

Creation 70 - Dry Back / Clic

Formats details on page 132



Onka



1056 Onka Pearl

Dry Back
Clic



1721 Onka Greige

Dry Back



1720 Onka Caramel

Dry Back
Clic



Onka Greige



0441 Honey Oak

Dry Back
Clic



0347 Ballerina

Dry Back
Clic



0455 Long Board

Dry Back
Clic



0504 Twist

Dry Back
Clic



0584 White Lime

Dry Back
Clic



0456 Ranch

Dry Back
Clic



Long Board



0556 Clifton

Dry Back



0577 Albion

Dry Back
Clic

Linear Wood



Linear Wood Clear



1702 Linear Wood Honey

Dry Back
Clic



1701 Linear Wood Clear

Dry Back



1703 Linear Wood Nature

Dry Back
Clic



Creation Tiles & Planks

Creation 70 - Dry Back / Clic

Formats details on page 132



Stony & Urban Street

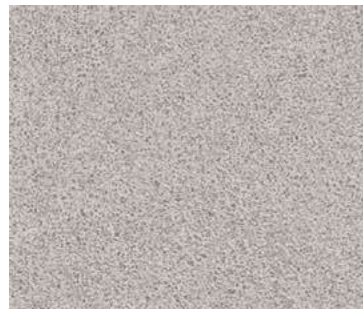

1283 Urban Street Light
Dry Back / Clic



1284 Urban Street Medium
Dry Back / Clic



1565 Urban Street Cream
Dry Back

Dock & East Village

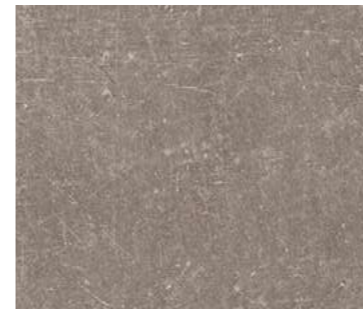

0087 Dock Taupe
Dry Back

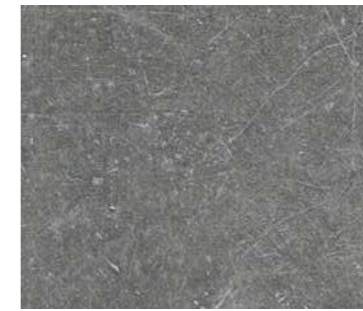

0085 Dock Grey
Dry Back



0522 East Village
Dry Back



1575 Stony Cream
Dry Back

Color scan scale: 1/4

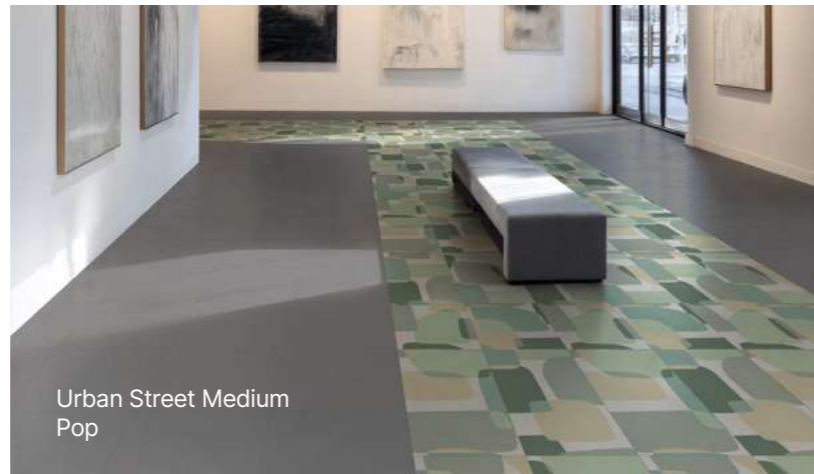

Urban Street Medium
Pop



Dock Taupe

Backyard & Pop



1711 Backyard Dark
Dry Back / Clic



1713 Backyard Taupe
Dry Back / Clic



1758 Pop
Dry Back

Color scan scale: 1/10



1723 Backyard Grey
Dry Back / Clic



1712 Backyard Light Beige
Dry Back

Marble

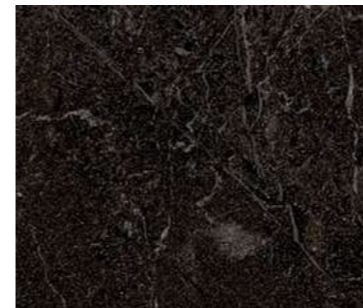

1722 Marble Black
Dry Back / Clic



1755 Marble Light Grey
Dry Back



Marble Black - Marble Light Grey

Creation Tiles & Planks

Creation 70 - Dry Back / Clic



Formats details on page 132



Chips & Urban Street



1725 Chips Cobalt
Dry Back



1724 Chips Amber
Dry Back

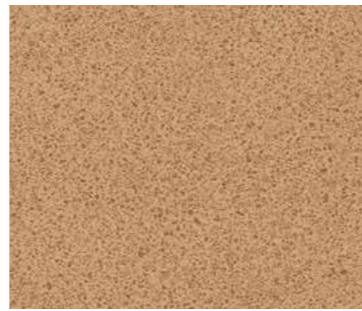

1726 Urban Street Amber
Dry Back

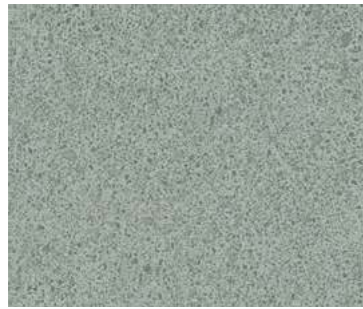

1727 Urban Street Cobalt
Dry Back



Curton Stone



1604 Curton Stone Taupe
Dry Back / Clic



Etna



1603 Curton Stone Clear
Dry Back / Clic



1068 Etna Beige
Dry Back



1069 Etna Dark
Dry Back

Full Design Concept



PVC Design Skirting
6086 + Color code
Cap x10: 60870001



MDF Design Skirting
5947 + Color code
Clip x 30: 59480001



Design Coverstrip
0642 + Color code

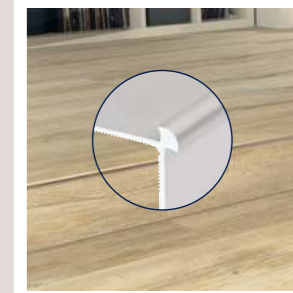

Stair Profile
E042 0001



Access for all
Easyplot: 059C0002 Grey
059C0003 Black / 059D0100 Alu
Easyguide: E2190006 Black



Transition Profile
0505 0001

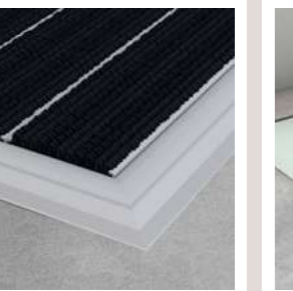

Entrance Mat
1700 0001 KIT ESPLANADE 9000
12MM - 1500X1518
1719 0001 ROMAT GT 12MM- 1500X1000

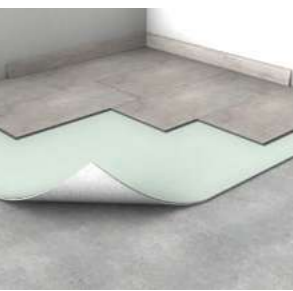

Acoustic Underlayer
1698 0001 Smartfix - Creation 30/40/55
5949 0001 Silence Plus 19dB - Creation 40/55 Clic
0704 0001 Acoustic Plus 19dB - Creation 40/55/70 Clic
1798 0001 Acoustic 15dB - Creation 40/55/70 Clic

Acoustic Underlayers

Impact sound insulation reduction:
Smartfix underlayer +
Creation 30/40/55 Dry Back: **16 dB**

Silence Plus 19 dB + Creation 40/55 Clic: **19 dB**

Acoustic 15 dB + Creation 40/55/70 Clic: **15 dB**

Acoustic Plus 19 dB + Creation 40/55/70 Clic: **19 dB**

Refer to Gerflor Installation guidelines on gerflor.com

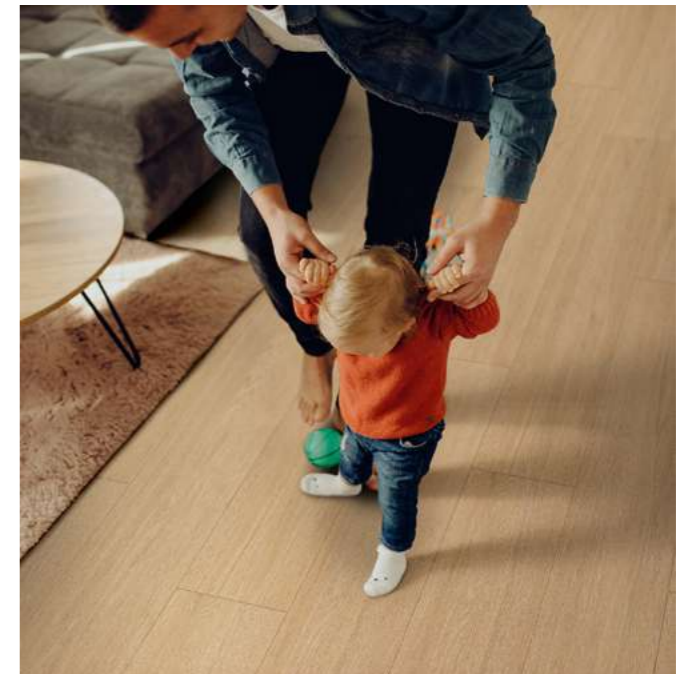

Creation Tiles & Planks

Cross references table

Code	Color Design	Creation 30				Creation 40				Creation 55				Creation 70	
		Dry Back	Dry Back	Clic	Clic Acoustic	Dry Back	Clic	Clic Acoustic	Dry Back	Clic	Dry Back	Clic			
0577	ALBION	-	-	-	-	-	-	-	-	-	-	-	-	-	-
1704	AQUINOAH BLOND	184x1219	-	-	-	184x1219 / HB: 152x762 / HP: 133x800	212x1239	212x1239 / HB: 125x750	-	-	-	-	184x1219	212x1239	-
1705	AQUINOAH BROWN	184x1219	-	-	-	184x1219	-	212x1239	-	-	-	-	-	-	-
1706	AQUINOAH HONEY	184x1219	-	-	-	184x1219 / HB: 152x762 / HP: 133x800	212x1239	212x1239 / HB: 125x750	-	-	-	-	-	-	-
1707	AQUINOAH NATURE	184x1219	-	-	-	184x1219 / HB: 152x762	212x1239	212x1239 / HB: 125x750	-	-	-	-	-	-	-
1711	BACKYARD DARK	610x610	-	-	-	389x729	-	389x729	-	-	-	610x610	389x729	-	-
1723	BACKYARD GREY	-	-	-	-	-	-	-	-	-	-	610x610	389x729	-	-
1712	BACKYARD LIGHT BEIGE	610x610	-	-	-	389x729	-	389x729	-	-	-	610x610	389x729	-	-
0347	BALLERINA	610x610	-	-	-	389x729	-	389x729	-	-	-	610x610	389x729	-	-
1599	BLOOM UNI CLEAR	610x610	-	-	-	389x729	-	389x729	-	-	-	610x610	389x729	-	-
1600	BLOOM UNI CREAM	610x610	-	-	-	389x729	-	389x729	-	-	-	610x610	389x729	-	-
1601	BLOOM UNI DARK	610x610	-	-	-	389x729	-	389x729	-	-	-	610x610	389x729	-	-
1602	BLOOM UNI PEARL	610x610	-	-	-	389x729	-	389x729	-	-	-	610x610	389x729	-	-
0853	BOSTONIAN OAK BEIGE	184x1219	184x1219	212x1239	212x1239	184x1219 / HB: 152x762	212x1239	212x1239 / HB: 125x750	184x1219	212x1239	212x1239	184x1219	212x1239	-	-
0851	BOSTONIAN OAK HONEY	184x1219	184x1219	-	-	184x1219	-	212x1239	-	-	-	-	-	-	-
0850	CEDAR BROWN	230x1500	230x1500	240x1461	240x1461	230x1500	240x1461	240x1461	230x1500	240x1461	240x1461	230x1500	240x1461	-	-
1605	CEDAR DARK BROWN	230x1500	230x1500	240x1461	240x1461	230x1500	240x1461	240x1461	230x1500	240x1461	240x1461	230x1500	240x1461	-	-
1606	CEDAR GOLDEN	230x1500	230x1500	240x1461	240x1461	230x1500	240x1461	240x1461	230x1500	240x1461	240x1461	230x1500	240x1461	-	-
1607	CEDAR NATURAL	230x1500	230x1500	240x1461	240x1461	230x1500	240x1461	240x1461	230x1500	240x1461	240x1461	230x1500	240x1461	-	-
1278	CHARMING OAK BEIGE	184x1219	-	-	-	184x1219	-	212x1239	-	-	-	-	-	-	-
1279	CHARMING OAK GREY	184x1219	-	-	-	184x1219	-	212x1239	-	-	-	-	-	-	-
1714	CHARMING OAK SMOKED	184x1219	-	-	-	184x1219	-	212x1239	-	-	-	-	-	-	-
1724	CHIPS AMBER	-	-	-	-	-	-	-	-	-	-	610x610	-	-	-
1725	CHIPS COBALT	-	-	-	-	-	-	-	-	-	-	610x610	-	-	-
1715	CITY OAK BEIGE	-	-	-	-	-	-	-	-	-	-	230x1500	240x1461	-	-
1716	CITY OAK BROWN	-	-	-	-	-	-	-	-	-	-	230x1500	240x1461	-	-
1717	CITY OAK DARK BROWN	-	-	-	-	-	-	-	-	-	-	230x1500	240x1461	-	-
1718	CITY OAK GREY	-	-	-	-	-	-	-	-	-	-	230x1500	240x1461	-	-
1719	CITY OAK HONEY	-	-	-	-	-	-	-	-	-	-	230x1500	240x1461	-	-
0556	CLIFTON	-	-	-	-	-	-	-	-	-	-	184x1219	-	-	-
1744	CONFETTI AMBER	-	-	-	-	-	-	-	-	-	-	610x610	389x729	-	-
1745	CONFETTI COBALT	-	-	-	-	-	-	-	-	-	-	610x610	389x729	-	-
1603	CURTON STONE CLEAR	457x914	457x914	389x729	389x729	457x914	389x729	389x729	457x914	389x729	389x729	457x914	389x729	-	-
1604	CURTON STONE TAUPE	457x914	457x914	389x729	389x729	457x914	389x729	389x729	457x914	389x729	389x729	457x914	389x729	-	-
0085	DOCK GREY	-	-	-	-	-	-	-	-	-	-	457x914	-	-	-
0087	DOCK TAUPE	-	-	-	-	-	-	-	-	-	-	457x914	-	-	-
0522	EAST VILLAGE	-	-	-	-	-	-	-	-	-	-	610x610	-	-	-
1068	ETNA BEIGE	-	-	-	-	-	-	-	-	-	-	457x914	-	-	-
1069	ETNA DARK	-	-	-	-	-	-	-	-	-	-	457x914	-	-	-
0441	HONEY OAK	184x1219	184x1219	212x1239	212x1239	184x1219	212x1239	212x1239	184x1219	212x1239	212x1239	184x1219	212x1239	-	-
1701	LINEAR WOOD CLEAR	-	-	-	-	-	-	-	-	-	-	184x1219	-	-	-
1702	LINEAR WOOD HONEY	-	-	-	-	-	-	-	-	-	-	184x1219	-	-	-
1703	LINEAR WOOD NATURE	-	-	-	-	-	-	-	-	-	-	184x1219	212x1239	-	-
0455	LONG BOARD	184x1219	184x1219	212x1239	212x1239	184x1219	212x1239	212x1239	184x1219	212x1239	212x1239	184x1219	212x1239	-	-
1272	LOUNGE OAK BEIGE	230x1500	230x1500	240x1461	240x1461	230x1500	240x1461	240x1461	230x1500	240x1461	240x1461	230x1500	240x1461	-	-
1274	LOUNGE OAK CHESTNUT	230x1500	230x1500	240x1461	240x1461	230x1500	240x1461	240x1461	230x1500	240x1461	240x1461	230x1500	240x1461	-	-
1271	LOUNGE OAK GOLDEN	230x1500	230x1500	240x1461	240x1461	230x1500	240x1461	240x1461	230x1500	240x1461	240x1461	230x1500	240x1461	-	-
1273	LOUNGE OAK NATURAL	230x1500	230x1500	240x1461	240x1461	230x1500	240x1461	240x1461	230x1500	240x1461	240x1461	230x1500	240x1461	-	-
1747	LUNA AMBER	-	-	-	-	-	-	-	-	-	-	610x610	-	-	-
1748	LUNA BEIGE	-	-	-	-	-	-	-	-	-	-	610x610	-	-	-
1749	LUNA COBALT	-	-	-	-	-	-	-	-	-	-	610x610	-	-	-
1722	MARBLE BLACK	-	-	-	-	-	-	-	-	-	-	914x914	389x729	-	-
1755	MARBLE LIGHT GREY	-	-	-	-	-	-	-	-	-	-	914x914	-	-	-
1720	ONKA CARAMEL	-	-	-	-	-	-	-	-	-	-	230x1500	240x1461	-	-
1721	ONKA GREIGE	-	-	-	-	-	-	-	-	-	-	230x1500	-	-	-
1056	ONKA PEARL	-	-	-	-	-	-	-	-	-	-	230x1500	240x1461	-	-
1729	PARADISO BONE	-	-	-	-	457x914	-	-	-	-	-	-	-	-	-
1730	PARADISO CREAM	-	-	-	-	457x914	-	-	-	-	-	-	-	-	-
1758	POP	-	-	-	-	-	-	-	-	-	-	496x996	-	-	-
0503	QUARTET	184x1219	184x1219	212x1239	212x1239	184x1219 / HB: 152x762	212x1239	212x1239 / HB: 125x750	184x1219	212x1239	212x1239	184x1219	212x1239	-	-
1597	QUARTET DARK BROWN	184x1219	184x1219	212x1239	212x1239	184x1219	212x1239	212x1239	184x1219	212x1239	212x1239	184x1219	212x1239	-	-
0870	QUARTET HONEY	184x1219	184x1219	212x1239	212x1239	184x1219	212x1239	212x1239	184x1219	212x1239	212x1239	184x1219	212x1239	-	-
0545	QUARTET NATURAL	184x1219	184x1219	212x1239	212x1239	184x1219	212x1239	212x1239	184x1219	212x1239	212x1239	184x1219	212x1239	-	-
0456	RANCH	184x1219	184x1219	212x1239	212x1239	184x1219	212x1239	212x1239	184x1219	212x1239	212x1239	184x1219	212x1239	-	-
1757	RESIN MARBLE	-	-	-	-	-	-	-	-	-	-	496x996	-	-	-
1742	SAHARA NOIR	-	-	-	-	-	-	-	-	-	-	457x914	-	-	-
1708	SAVAGE OAK GREIGE	184x1219	-	-	-	184x1219	-	212x1239	-	-	-	184x1219	-	-	-
1709	SAVAGE OAK HONEY	184x1219	-	-	-	184x1219	-	212x1239	-	-	-	184x1219	-	-	-
1710	SAVAGE OAK SMOKED	184x1219	-	-	-	184x1219	-	212x1239	-	-	-	184x1219	-	-	-
1575	STONY CREAM	-	-	-	-	-	-	-	-	-	-	610x610	-	-	-
1567	TAMO CLEAR	184x1219	184x1219	-	-	184x1219	-	212x1239	-	-	-	184x1219	-	-	-
1598	TAMO CREAM	184x1219	184x1219	-	-	184x1219	-	212x1239	-	-	-	184x1219	-	-	-
1568	TAMO LIGHT BROWN	184x1219	184x1219	-	-	184x1219	-	212x1239	-	-	-	184x1219	-	-	-
1561	TAMO NATURAL	184x1219	184x1219	-	-	184x1219	-	212x1239	-	-	-	184x1219	-	-	-
0504	TWIST	184x1219	184x1219	212x1239	212x1239	184x1219 / HB: 152x762	212x1239	212x1239 / HB: 125x750	184x1219	212x1239	212x1239	184x1219	212x1239	-	-
1726	URBAN STREET AMBER	-	-	-	-	610x610	-	-	-	-	-	610x610	-	-	-
1727	URBAN STREET COBALT	-	-	-	-	610x610	-	-	-	-	-	610x610	-	-	-
1565	URBAN STREET CREAM	-	-	-	-	610x610	-	389x729	-	-	-	610x610	-	-	-
1283	URBAN STREET LIGHT	-	-	-	-	914x914	-	389x729	-	-	-	914x914	389x729	-	-
1284	URBAN STREET MEDIUM	-	-	-	-	914x914	-	389x729	-	-	-	914x914	389x729	-	-

Structure your spaces,
create harmony



Creation Looselay

Creation
Tiles & Planks

52 designs

6 sizes

100% design harmony

Discover the quality and expertise of Gerflor in this collection designed to perfectly combine colours, patterns and formats.

The most comprehensive Looselay range

Creation 55 Looselay
Creation 55 Looselay Acoustic
Creation 70 Looselay
Creation Saga²

Multi-formats



A dedicated collection for hospitality, offices, commercial areas, and retail stores

Full design concept



Skirtings
Plinthes



Profiles
Profilsés



Mats
Tapis



Wall - Mural
Revela

EASY TO MATCH WITH GERFLOR
CARPET COLLECTIONS

Chips Green / Tamo Light / Marble Dark

Creation Tiles & Planks

Creation 55/70 Looselay



The fastest to install!

- No adhesive, no clic
- No down time - Direct use after installation



The easiest to mix!

- Easy herringbone installation
- Square format
- Easy mix & match



The most durable!

- Reinforced structure with fiber glass veil
- Easy replacement



All the benefits of Looselay engineered by Gerflor

- Renovation on ceramic
- Compatible with raised access floors
- Acoustic comfort (walking noise < 73 dB)



Designed by Gerflor

- High definition design
- Ultra realistic surface
- 4 bevelled edges
- 52 designs to be mixed



① Exclusive ProtecShield™ surface treatment

② 4D Design

③ Duocore Technology

④ Grip-wave backlayer
Anti-slip backing

⑤ Creation 55 Looselay Acoustic
Integrated acoustic underlay
Sound insulation 19 dB

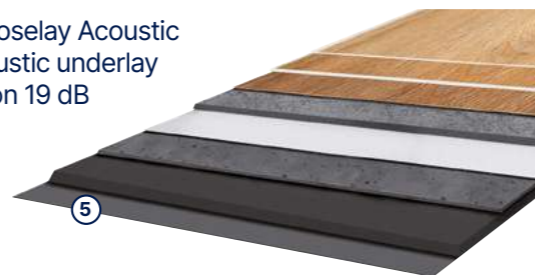

Creation 55 Looselay

Creation 55 Looselay is a synthetic, decorative, flexible, antistatic, abrasion group T floorcovering available in tiles and planks. It consists in a 0.55 mm thick transparent wear layer, a design film and a Duo Core Technology, made with a rigid core back layer reinforced with a fiber veil, combined with a flexible core top layer to provide softness and comfort surface. The overall thickness is 4.5 mm. It also includes anti-skid backing to allow an easy installation and a glue-free installation up to 30 sqm. It benefits from a cross-linked polyurethane surface treatment (**Protecshield™**), making maintenance easier and eliminating the need for initial polishes.

Creation 55 Looselay is a looselay floorcovering, resistant to use (commercial / industrial use) of 33-42 according to EN-ISO 10874 and has Bfl-s1 class for smoke emission according to EN 13501-1.

Creation 55 Looselay is made with phthalate free plasticizers, except recycled content. It is 100% recyclable and made with 35% of recycled content. It is REACH compliant. **The product emission rate of organic compounds is < 10 microgram/m³** (TVOC < 28 days – ISO 16000-6).

Creation 55 Looselay Acoustic

Creation 55 Looselay Acoustic is a synthetic, decorative, flexible, antistatic, abrasion group T floorcoverings available in tiles and planks with bevelled edges. It consists in a 0.55 mm thick transparent wear layer, a design film and a Duo Core Technology, made with a rigid core back layer reinforced with a fiber veil, combined with a flexible core top layer to provide softness and comfort surface. The backing integrates an acoustic core reaching 19 dB acoustic impact noise reduction. The overall thickness is 5.5 mm. They benefit from a cross-linked polyurethane surface treatment (**Protecshield™**), making maintenance easier and

eliminating the need for initial polishes.

Creation 55 Looselay Acoustic is a looselay floorcovering, resistant to use (commercial / industrial use) of 33-42 according to EN-ISO 10874 and has Bfl-s1 class for smoke emission according to EN 13501-1.

Creation 55 Looselay Acoustic is made with phthalate free plasticizers, except recycled content. It is 100% recyclable and made with 35% of recycled content. It is REACH compliant. **The product emission rate of organic compounds is < 10 microgram/m³** (TVOC < 28 days – ISO 16000-6).

Creation 70 Looselay

Creation 70 Looselay is a synthetic, decorative, flexible, antistatic, abrasion group T floorcovering available in tiles and planks, with bevelled edges. It consists in a 0.70 mm thick transparent wear layer, a design film and a Duo Core Technology, made with a rigid core back layer reinforced with a fiber veil, combined with a flexible core top layer to provide softness and comfort surface. The overall thickness is 6 mm. It also includes anti-skid backing to allow an easy installation. It benefits from a cross-linked polyurethane surface treatment (**PUR+ Matt**), making maintenance easier and eliminating the need for initial polishes.

Creation 70 Looselay is a looselay floorcovering, resistant to use (commercial / industrial use) of 34-43 according to EN-ISO 10874 and has Bfl-s1 class for smoke emission according to EN 13501-1.

Creation 70 Looselay is made with phthalate free plasticizers, except recycled content. It is 100% recyclable and made with 35% of recycled content. It is REACH compliant.

The product emission rate of organic compounds is < 10 microgram/m³ (TVOC < 28 days – ISO 16000-6).

Sustainability & comfort in one product!



100% recyclable through Gerflor's Second Life Program
Up to 35% recycled content



Great indoor air quality
TVOC emissions
<10 micrograms/m³ after 28 days



Reach compliant



Carbon footprint
EPD available



Adhesive Free Installation
Up to 30 sqm



Easy to remove
Easy to re-use

Creation Tiles & Planks

Creation 55 - Looselay / Looselay Acoustic

Chevrons 



1561 Tamo Natural / 1567 Tamo Clear /
1568 Tamo Light Brown



Formats details
on page 149



Looselay

Tamo



1559 Tamo Light

Looselay
Looselay Ac



1561 Tamo Natural

Looselay
Looselay Ac



1560 Tamo Dainty

Looselay
Looselay Ac



1568 Tamo Light Brown

Looselay



1567 Tamo Clear

Looselay



Tamo Dainty



Creation Tiles & Planks

Creation 55 - Looselay / Looselay Acoustic

Formats details on page 149



0455 Long Board

Looselay
Looselay Ac



0441 Honey Oak

Looselay



0347 Ballerina

Looselay
Looselay Ac



0456 Ranch

Looselay
Looselay Ac



0504 Twist

Looselay



0796 Swiss Oak Golden

Looselay



Twist & Swiss Oak Golden

Urban Street



1565 Urban Street Cream
Looselay



Urban Street Light 1283
Looselay
Looselay Ac



1284 Urban Street Medium
Looselay
Looselay Ac

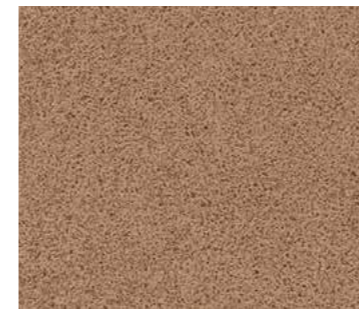

1566 Urban Street Terra
Looselay



Urban Street Terra / Gentleman Terra

Creation Tiles & Planks

Creation 55 - Looselay / Looselay Acoustic



Formats details on page 149



Gentleman Grey

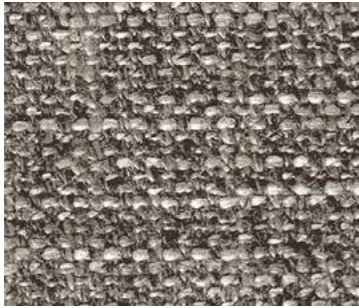

1083 Gentleman Taupe
Looselay



1563 Gentleman Cream
Looselay



1564 Gentleman Terra
Looselay

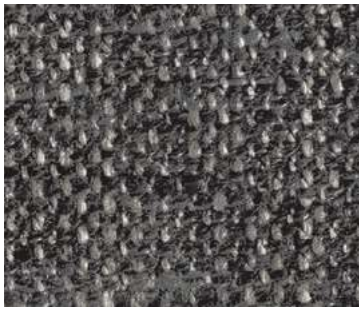

1058 Gentleman Grey
Looselay



Gentleman Grey /
Urban Street Light



0374 Parker Station
Looselay



0436 Riverside
Looselay

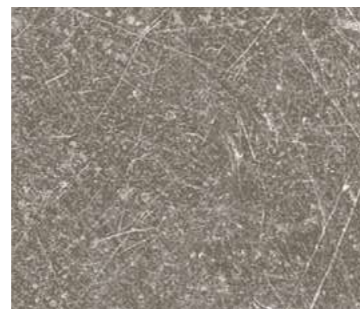

0087 Dock Taupe
Looselay



0868 Bloom Uni Taupe
Looselay

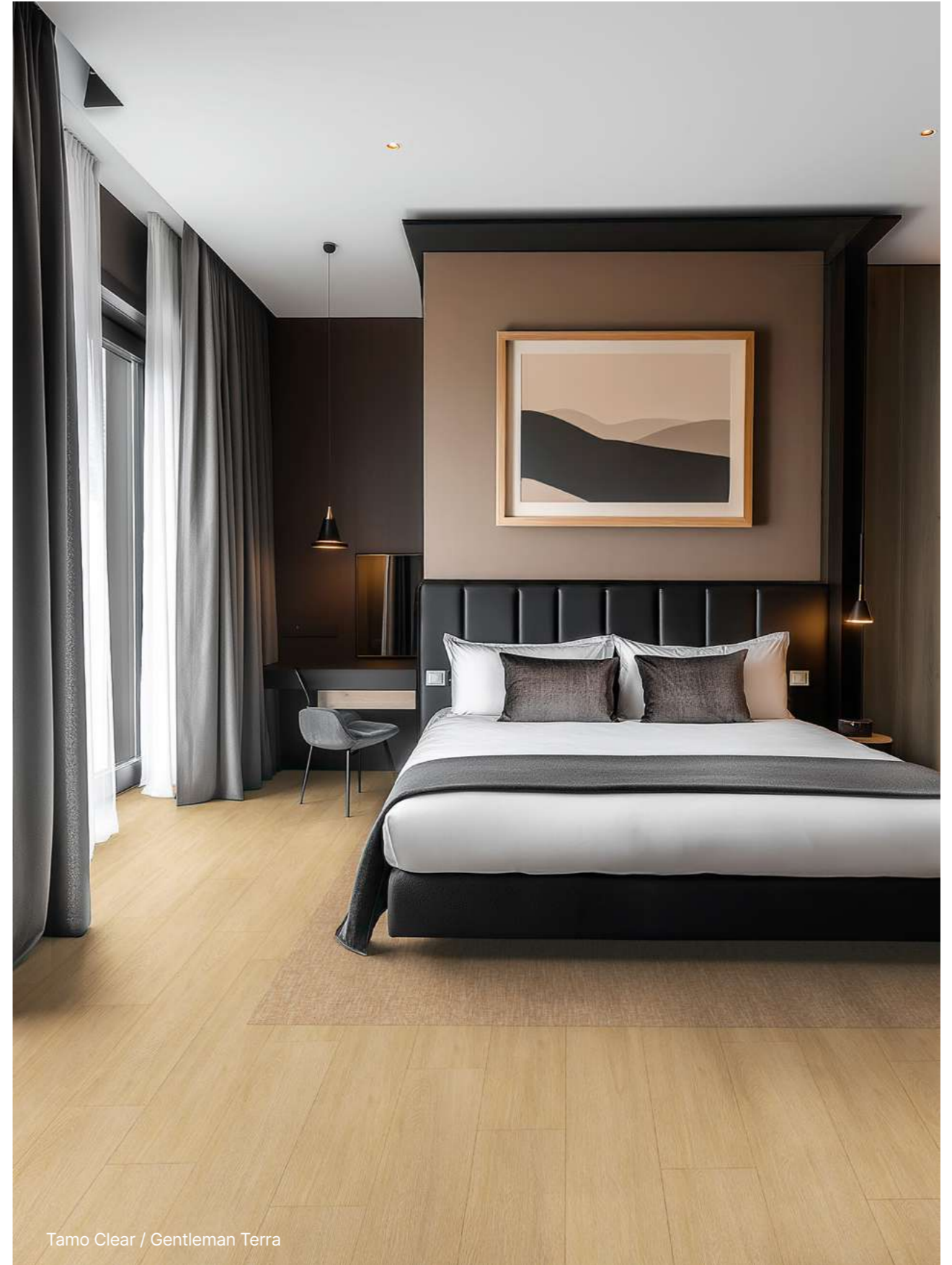

Tamo Clear / Gentleman Terra

Creation Tiles & Planks

Creation 70 Looselay

Chevrons 



 Formats details on page 149



Tamo



1559 Tamo Light

Looselay



1560 Tamo Dainty

Looselay



1567 Tamo Clear

Looselay



1561 Tamo Natural

Looselay



1568 Tamo Light Brown

Looselay

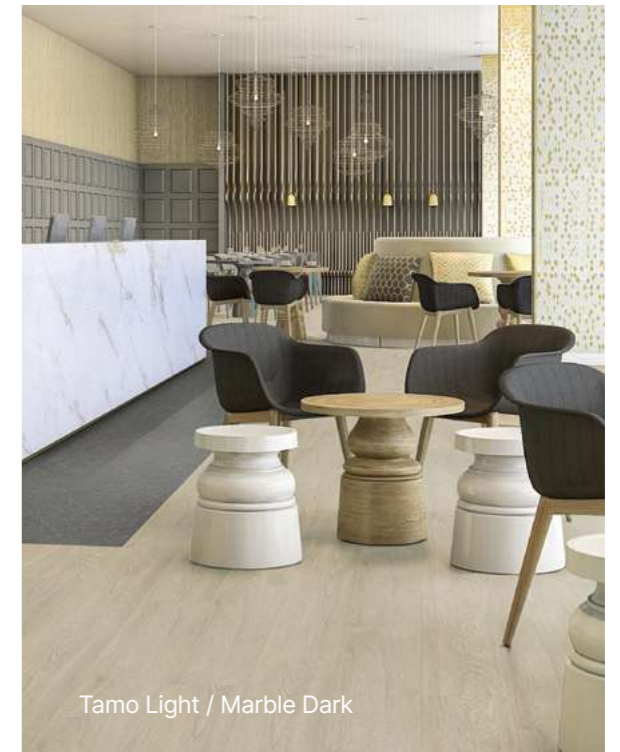

Namou



1578 Namou Light Honey

Looselay



1579 Namou Honey

Looselay



1580 Namou Dark Honey

Looselay

Creation Tiles & Planks

Creation 70 Looselay

Formats details on page 149



0060 Arena

Looselay



0504 Twist

Looselay



0456 Ranch

Looselay



0455 Long Board

Looselay

Chips



1574 Chips Terra
Looselay



1573 Chips Green
Looselay



1572 Chips Blue
Looselay



Marble Green / Chips Green

Urban Street



1577 Urban Street Dark
Looselay



1566 Urban Street Terra
Looselay

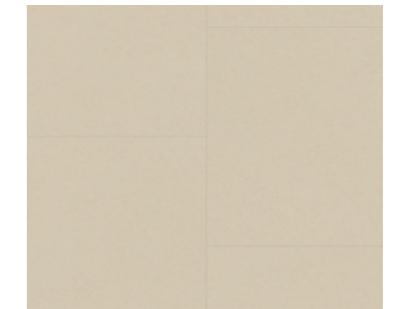

1565 Urban Street Cream
Looselay



1284 Urban Street Medium
Looselay



1283 Urban Street Light
Looselay



Stony Cream /
Urban Street Cream

Stony



1576 Stony Medium
Looselay

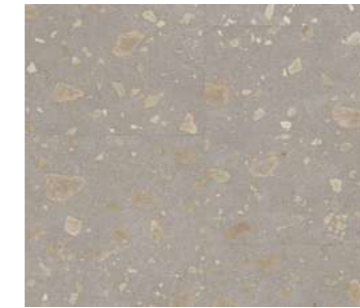

1575 Stony Cream
Looselay

Creation Tiles & Planks

Creation 70 Looselay

Formats details on page 149



Marble

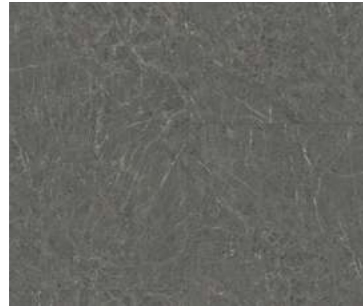

1570 Marble Dark Looselay



0085 Dock Grey Looselay



1569 Marble Clear Looselay

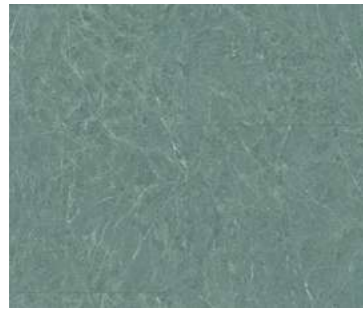

1571 Marble Green Looselay



Marble Dark / Marble Clear

Code	Color	Design	Creation 55 Looselay	Creation 55 Looselay Acoustic	Creation 70 Looselay	Skirting Matching Design	Coverstrip Matching Design	Emboss	NCS	LRV
0060	Arena	-	-	-	229x1220	S026	-	Natural	4005-Y20R	37,2
0347	Ballerina	229 x 1220	229 x 1220	-	-	S008	C008	Natural	4040-Y20R	28,4
0868	Bloom Uni Taupe	600 x 600	-	-	-	S072	C019	Hammered	4502-Y	28,5
1572	Chips Blue	-	-	600x600	-	-	-	Hammered	1502-B	62,5
1573	Chips Green	-	-	600x600	-	-	-	Hammered	1502-G	53,2
1574	Chips Terra	-	-	600x600	-	-	-	Hammered	1502-Y	64,6
0085	Dock Grey	-	-	914x914	-	S111	C015	Hammered	6500-N	20,1
0087	Dock Taupe	914 x 914	-	-	-	S020	C019	Hammered	6005-Y50R	19,2
1563	Gentleman Cream	600 x 600 152 x 914	-	-	-	-	-	Textile	3010-Y40R	40,1
1058	Gentleman Grey	600 x 600 152 x 914	-	-	-	-	-	Textile	7500-N	12,7
1083	Gentleman Taupe	600 x 600	-	-	-	-	-	Textile	5502-Y	21,2
1564	Gentleman Terra	600 x 600	-	-	-	-	-	Textile	4020-Y30R	27
0441	Honey Oak	229 x 1220	-	-	-	S033	C006	Natural	4020-Y20R	27,7
0455	Long Board	229 x 1220	229 x 1220	229x1220	-	S034	C006	Brushed	4010-Y30R	24,8
1569	Marble Clear	-	-	914x914 / 152x914	-	-	-	Hammered	2000-N	53,8
1570	Marble Dark	-	-	914x914 / 152x914	-	-	-	Hammered	7502-R	13,9
1571	Marble Green	-	-	914x914	-	-	-	Hammered	5010-G10Y	24,6
1580	Namou Dark Honey	-	-	235x1505	-	S008	-	Natural	4030-Y20R	23,5
1579	Namou Honey	-	-	235x1505	-	S058	-	Natural	4020-Y20R	33,6
1578	Namou Light Honey	-	-	235x1505	-	S019	C006	Natural	3020-Y20R	34,5
0374	Parker Station	914 x 914	-	-	-	S047	C023	Hammered	8000-N	12,6
0456	Ranch	229 x 1220	229 x 1220	229x1220	-	S053	C014	Brushed	5005-Y50R	23,5
0436	Riverside	600 x 600	-	-	-	S032	-	Hammered	6502-Y	16,7
1575	Stony Cream	-	-	600x600	-	-	-	Hammered	3502-Y	35,8
1576	Stony Medium	-	-	600x600	-	-	-	Hammered	3502-B	38,1
0796	Swiss Oak Golden	229 x 1220	-	-	-	S015	C003	Natural	4030-Y20R	25,8
1567	Tamo Clear	229 x 1220 152 x 914	-	229x1220 / 152x914	-	S168	C006	Natural	3020-Y20R	33,3
1560	Tamo Dainty	229 x 1220	229 x 1220	229x1220	-	-	-	Natural	4020-Y30R	24
1559	Tamo Light	229 x 1220 152 x 914	229 x 1220	229x1220 / 152x914	-	S188	C005	Natural	3010-Y20R	36,6
1568	Tamo Light Brown	229 x 1220 152 x 914	-	229x1220 / 152x914	-	S202	C003	Natural	5020-Y30R	17,2
1561	Tamo Natural	229 x 1220	229 x 1220	229x1220	-	S016	C004	Natural	4020-Y20R	24,4
0504	Twist	229 x 1220	-	229x1220	-	S039	C011	Natural	3010-Y30R	38,9
1565	Urban Street Cream	600 x 600	-	600x600	-	-	-	Hammered	2005-Y20R	50
1577	Urban Street Dark	-	-	914x914	-	-	-	Hammered	7500-N	11,1
1283	Urban Street Light	914 x 914	600 x 600	914x914	-	S094	-	Hammered	3000-N	42,3
1284	Urban Street Medium	914 x 914	600 x 600	914x914	-	S180	C016	Hammered	4502-R	26,5
1566	Urban Street Terra	600 x 600	-	600x600	-	-	-	Hammered	5020-Y50R	21,6

S001: White S001: Aluminium

Packaging

Format (mm)	m ² /box	m ² /palett
Creation 55 Looselay		
229 x 1220	1,67	113,6
152 x 914	1,67	110,2
600 x 600	2,16	103,7
914 x 914	3,34	116,9
Creation 55 Looselay Acoustic		
229x1220	2,23	124,9
600x600	2,16	103,7
Creation 70 Looselay		
229 x 1220	1,67	100,2
152 x 914	1,67	100,2
235 x 1505	1,41	95,9
600 x 600	1,44	83,5
914 x 914	3,34	100,2

Exclusive embosses



Textile

Hammered



Brushed

Natural

Creation Tiles & Planks

Creation Saga²
Eco-design "made in Europe"



71% Natural, mineral & recycled content



100% recyclable through Gerflor's Second Life Program

Up to 35% recycled content



100% Made in Europe



Carbon footprint EPD available

70% Content coming from France



**Easy to remove
Easy to re-use**

Cork: performance by nature



Natural & rapidly renewable (7 years)



Strong indentation resistance



Natural acoustic properties
(15dB insulation & walking noise <65dB)

15 dB



<65 dB

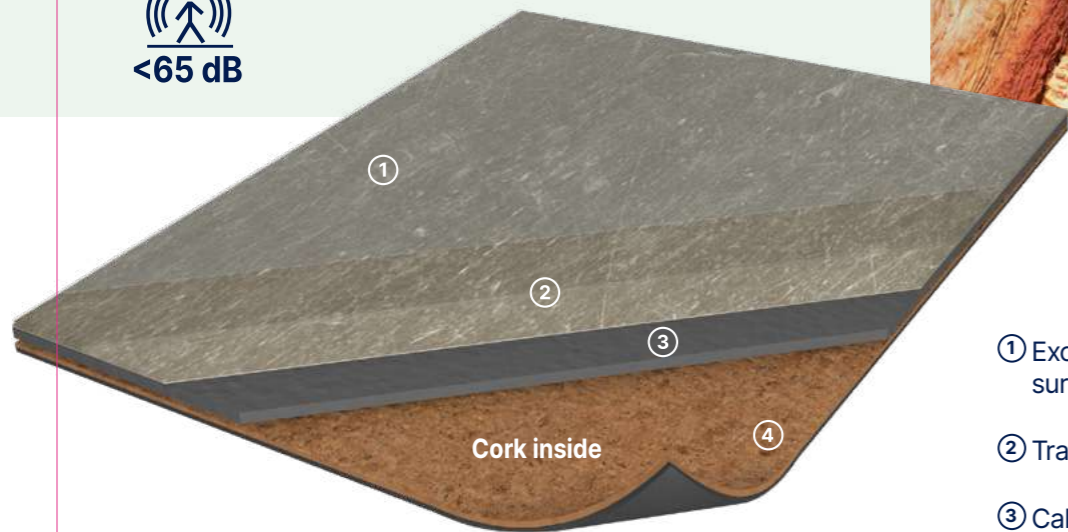

Cork inside

- ① Exclusive ProtecShield™ surface treatment
- ② Transparent 0.7 mm wearlayer
- ③ Calendered interlay
- ④ Cork + PVC underlayment

Creation Saga²

SAGA² is a synthetic, decorative, flexible, antistatic, abrasion group T floorcoverings available in tiles and planks. It consists in a 0,70 mm thick transparent wear layer, a design film and an exclusive double calandered layer which integrated cork particles. The overall thickness is 4.6 mm. The cork particles bring a natural acoustic insulation of 15dB and walking noise <65dB.

It benefits from a cross-linked polyurethane surface treatment (**Protecshield™**), making maintenance easier and eliminating the need for initial polishes.

SAGA² is a looselay floorcovering, resistant to use (commercial / industrial use) of 34 / 43 according to EN-ISO 10874 and has Bfl-s1 class for smoke emission according to EN 13501-1. **SAGA²** is made with phthalate free plasticizers, except recycled content. It is 100% recyclable and have up to 35% of recycled content. It is REACH compliant. **The product emission rate of organic compounds is < 10µg/m³ (TVOC <28 days – ISO 16000-6).**

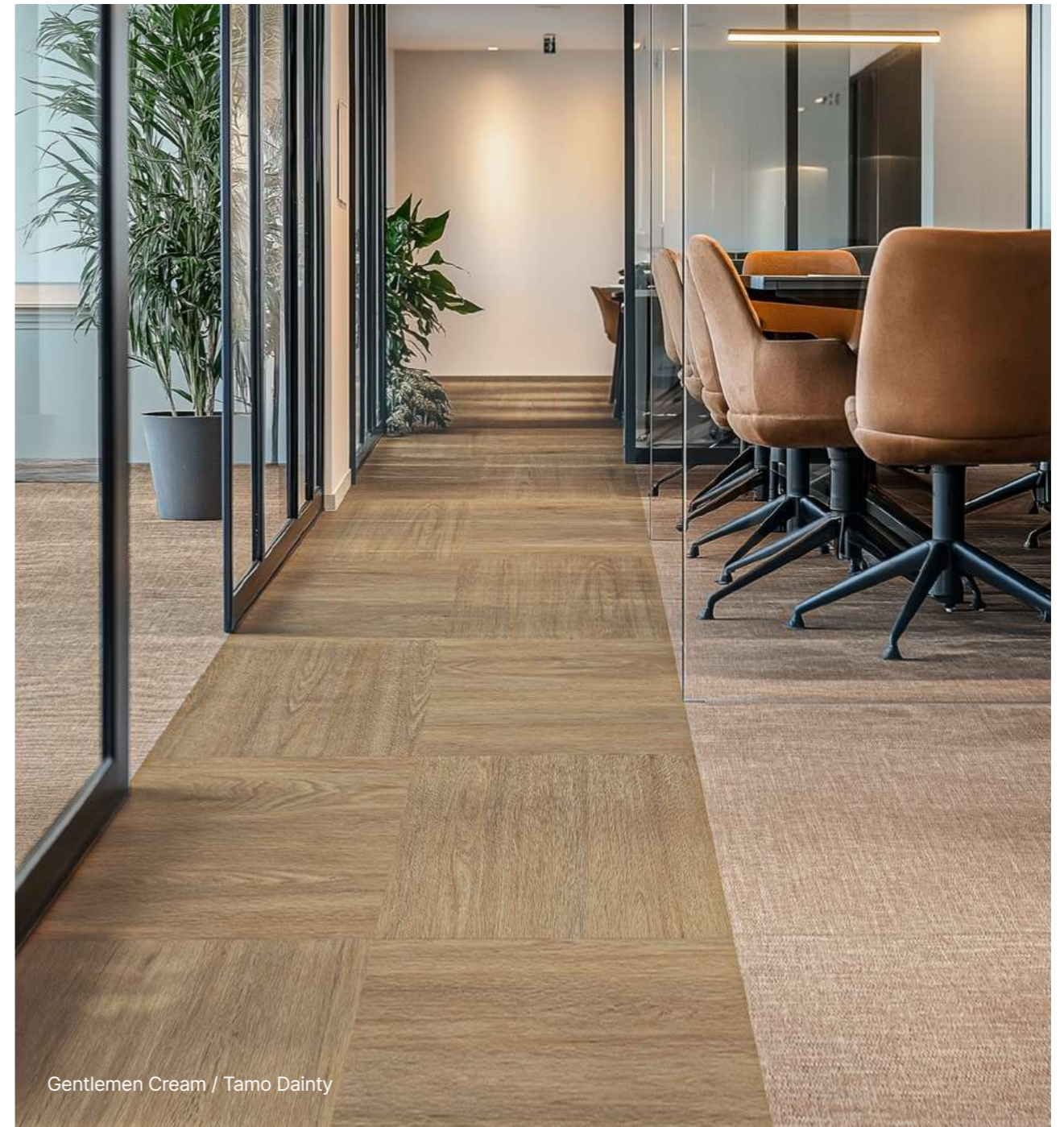

Gentlemen Cream / Tamo Dainty

For more information, please refer to Gerflor installation guidelines.

Creation Tiles & Planks

Creation Saga²

500 x 500 mm **Protecshield™**



Tweed



1587 Tweed Medium Beige



1584 Tweed Chine Amande



1585 Tweed Green Chine



Gentleman



0088 Gentleman Grey



1582 Gentleman Jean Chine



0030 Gentleman Blue

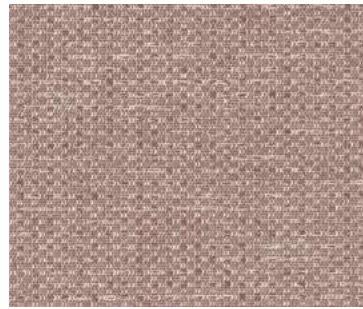

1588 Tweed Rose Ancien

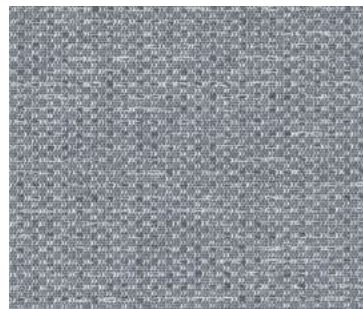

1586 Tweed Light Grey



0089 Gentleman Taupe



1564 Gentleman Terra



1563 Gentleman Cream



1581 Gentleman Abricot



Oxyd Light

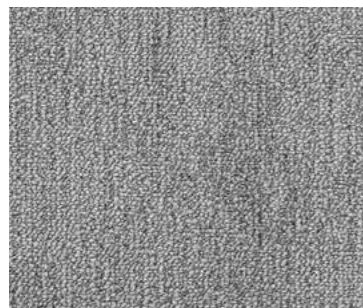

1610 Oxyd Light Grey



1608 Oxyd Light Beige



1609 Oxyd Light Green



Scale: 1/5th

Creation Tiles & Planks

Creation Saga²



Urban Street

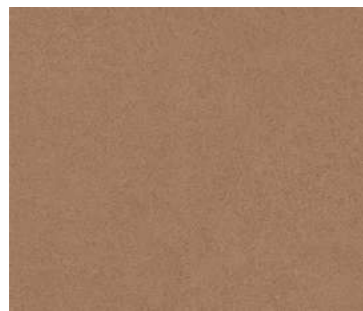

1566 Urban Street Terra



1284 Urban Street Medium



1283 Urban Street Light



1565 Urban Street Cream



Tamo



1559 Tamo Light



Tamo Light

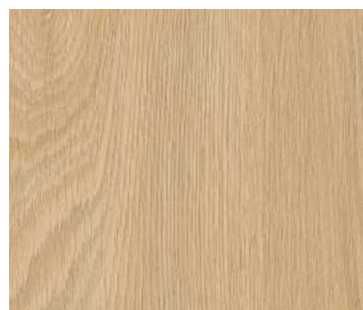

1567 Tamo Clear



1560 Tamo Dainty



1561 Tamo Natural



Scale: 1/5th

154 Design shade variation: Light Medium high

Code	Color Design	Skirting Matching Design	Emboss	NCS	LRV
1581	Gentleman Abricot	S001	Textile	4030-Y40R	23,5
0030	Gentleman Blue	S001	Textile	8010-R70B	8,7
1563	Gentleman Cream	S001	Textile	3010-Y40R	40,1
0088	Gentleman Grey	S001	Textile	7500-N	12,7
1582	Gentleman Jean Chine	S001	Textile	6005-B20G	22,8
0089	Gentleman Taupe	S001	Textile	5502-Y	21,2
1564	Gentleman Terra	S001	Textile	4020-Y30R	27,0
1608	Oxyd Light Beige	S001	Textile	4502-Y	30
1609	Oxyd Light Green	S001	Textile	4020-B50G	24,2
1610	Oxyd Light Grey	S001	Textile	-	-
1567	Tamo Clear	S001	Natural	3020-Y20R	33,3
1560	Tamo Dainty	S001	Natural	4020-Y30R	24,0
1559	Tamo Light	S001	Natural	3010-Y20R	36,6
1561	Tamo Natural	S001	Natural	4020-Y20R	24,4
1584	Tweed Chine Amande	S001	Textile	5010-G10Y	27,8
1585	Tweed Jean Chine	S001	Textile	-	-
1586	Tweed Light Grey	S001	Textile	4502-B	29,3
1587	Tweed Medium Beige	S001	Textile	-	-
1588	Tweed Rose Ancien	S001	Textile	4010-Y90R	31,9
1565	Urban Street Cream	S178	Hammered	2005-Y20R	50,0
1283	Urban Street Light	S094	Hammered	3500-N	39,1
1284	Urban Street Medium	S180	Hammered	4502-B	28,4
1566	Urban Street Terra	S001	Hammered	5020-Y50R	21,6
1284	Urban Street Medium	S180	Hammered	4502-R	26,5
1566	Urban Street Terra	S001	Hammered	5020-Y50R	21,6

S001: White

Packaging

Format (mm)	m ² /box	m ² /palett
500 × 500	2,5	110

Exclusive embosses



Natural



Hammered



Textile

Creation Tiles & Planks

Creation 70 Connect



 Interlocking installation with dovetails

 Fast and easy renovation

 Adhesive free

 All over effect



- ① PUR+ Matte surface treatment
- ② 4D Design
- ③ Resilient reinforced core
- ④ Exclusive patented dovetails



Oak Golden

Creation 70 Connect

Creation 70 Connect is a synthetic, decorative, flexible, antistatic, abrasion group T floorcovering available in tiles. It consists in a 0.70 mm thick transparent wear layer, a design film, a calendered layer and a PVC compact sublayer reinforced with fibers. The overall thickness is 5 mm. It benefits from a cross-linked polyurethane surface treatment (**PUR+ Matt**), making maintenance easier and eliminating the need for initial polishes.

Creation 70 Connect is an interlocking floorcovering, resistant to use (commercial / industrial use of 34-43 according to EN-ISO 10874 and has Bfl-s1 class for smoke emission according to EN 13501-1. **Creation 70 Connect** is made with phthalate free plasticizers, except recycled content. It is 100% recyclable and made with 55% of recycled content. It is REACH compliant. **The product emission rate of organic compounds is < 10 microgram/m³ (TVOC < 28 days – ISO 16000-6).**



Gentleman Taupe / Dalma Grey



Entrance mats / Tapis d'entrée
Kit Romat GT 1719
1500x1000 mm



Aluminium Profile 0505
(Corner 1513)



Anti Bounce Mallet / Maillet anti-rebond 5951

Creation Tiles & Planks

Creation 70 Connect



Gentleman



1083 Gentleman Taupe



1058 Gentleman Grey

Dock



0085 Dock Grey

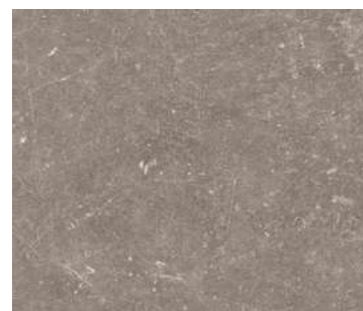

0087 Dock Taupe

Rough Textile



0063 Rough Textile Grey



0062 Rough Textile Beige

Dalma

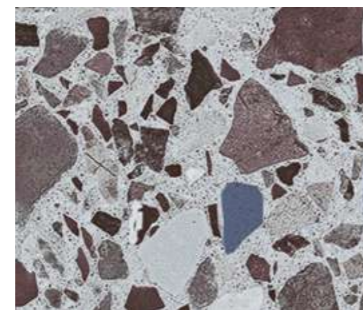

1089 Dalma Burgundy

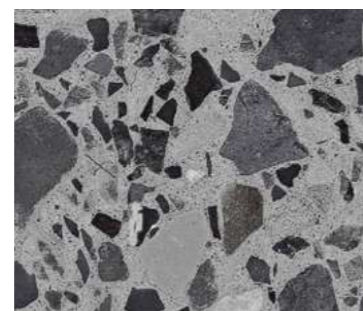

1088 Dalma Grey

Oak



0090 Oak Light



1492 Oak Golden



0091 OSB Natural

Code	Color Design	Connect	Skirting Matching Design	Emboss	NCS	LRV
0085	Dock Grey				6500-N	20.1
0087	Dock Taupe				6005-Y50R	19.2
1058	Gentleman Grey				7500-N	12.7
1083	Gentleman Taupe				5502-Y	21.2
1089	Dalma Burgundy				6005-Y80R	24.7
1088	Dalma Grey				7005-R80B	19
1492	Oak Golden				4020-Y30R	27.9
0090	Oak Light				5500-N	21.1
0091	Os Natural				2010-Y40R	41.6
0062	Rough Textile Beige				5005-Y20R	25.4
0063	Rough Textile Grey				5500-N	21.1

└ S001: White ─┘

Packaging

Format (mm)	m ² /box	m ² /palett
701,3 × 701,3	-	49,14

Exclusive embosses



Natural



Hammered



Textile



OSB Natural

Creation Tiles & Planks

Creation 70 MegaClic **New**



New design collection

 **Inspired by the latest Interior Design Trends for Commercial Spaces**

 **Designed to combine with GTI® or Design Tile and reach perfect harmony**

Designed for Comfort & Safety

 **Noise reduction vs ceramic**
Acoustic comfort

 **R10**
Slip resistance

 **ProtecShield™ surface treatment**
Easy cleaning

Patented by Gerflor

 **Patented double vertical clic specifically designed for high traffic environments**

 **Rolling traffic compliant* up to 700kg**

 **Adhesive free installation***

 **Renovation over ceramic**

 **Easy to replace**



- ① ProtecShield® High Performance Surface Treatment
- ② Ultrarealistic & Embossed Wear Layer
- ③ Smart Design Expanded pattern variation → Authentic, natural look
- ④ Resilient reinforced core
- ⑤ Patented double vertical clic

Creation 70 MegaClic

Creation 70 MegaClic is a synthetic, decorative, flexible, antistatic, abrasion group T floor coverings available in tiles and planks, with beveled edges. It consists of a 0,70 mm thick transparent wear layer, a design film and reinforced with glass fiber particles, combined with a flexible core top layer to provide softness and comfort surface. The overall thickness is 6 mm. They benefit from a cross-linked polyurethane surface treatment (ProtecShield™), making maintenance easier and eliminating the need for initial polishes.

Creation 70 MegaClic is an interlocking floor covering assembled with a double vertical clic on the long and short side for a quick and solid installation. The resistance to use (commercial / industrial use) of 34 / 43 according to EN-ISO 10874 and has Bfl-s1 class for smoke emission according to EN 13501-1. **Creation 70 MegaClic** is made with phthalate free plasticizers, except recycled content. It is 100% recyclable and made with 29% recycled content. It is REACH compliant. The product emission rate of organic compounds is <math>< 10\mu\text{g}/\text{m}^3</math> (TVOC <math>< 28</math> days – ISO 16000-6).

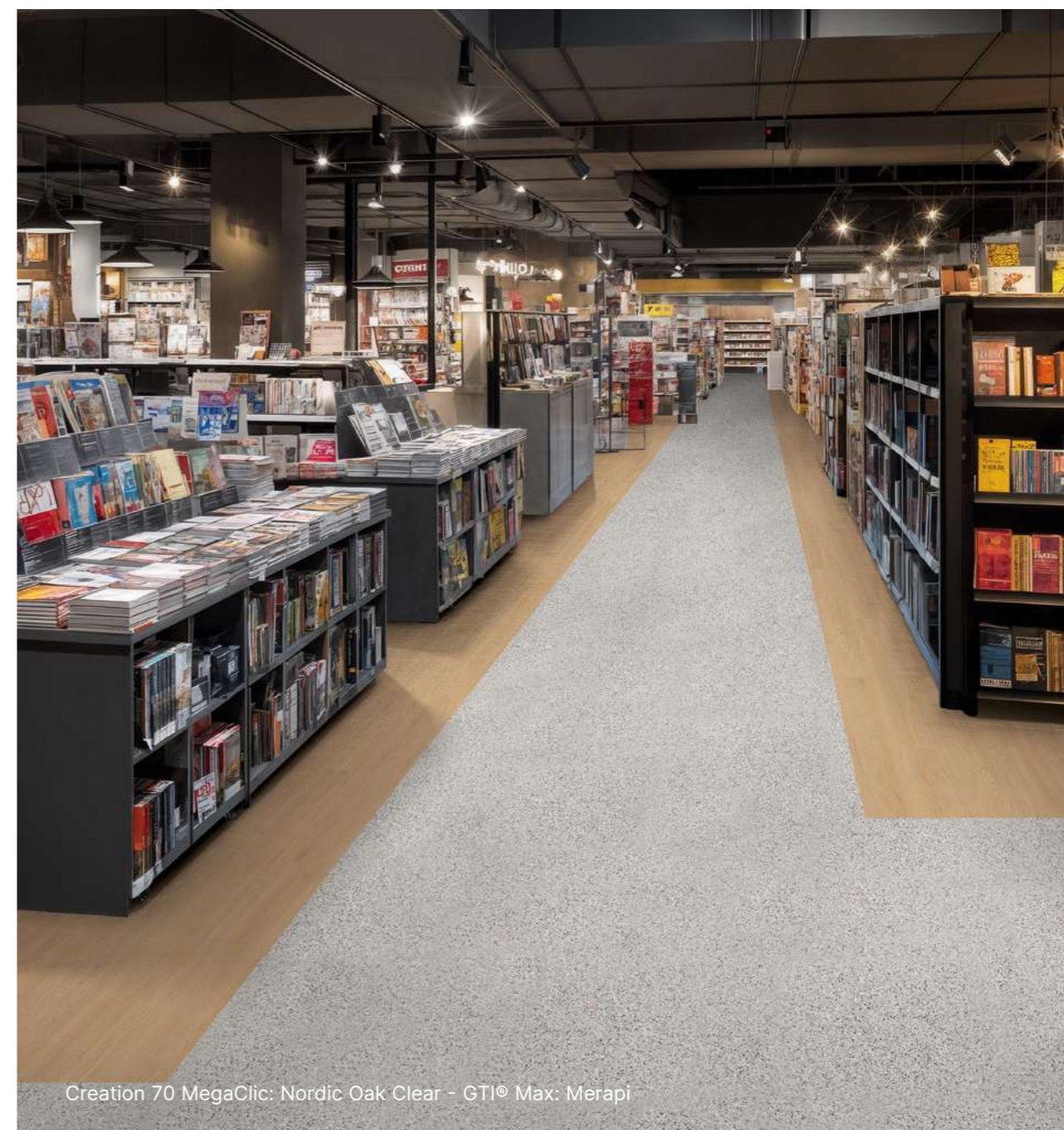

Creation 70 MegaClic: Nordic Oak Clear - GTI® Max: Merapi

Creation Tiles & Planks

Creation 70 MegaClic **New**

200.5 x 1235.5 mm **Protecshield™**



Bodega



1766 Bodega Chestnut



1767 Bodega Natural

Albion



0577 Albion



1763 Albion Honey



1762 Albion Beige



Albion Beige



0545 Serena



0800 Toasted Wood Roadster



1764 Nordic Oak Clear



0358 Moon Island



1052 Muse Sand



0357 Portobello



1765 Nordic Oak Natural



0538 Midwest



Nordic Oak Clear - Prado Grey

Creation
Tiles & Planks

Creation Tiles & Planks

Creation 70 MegaClic New



Camino



1771 Camino Medium Grey



1770 Camino Light Grey

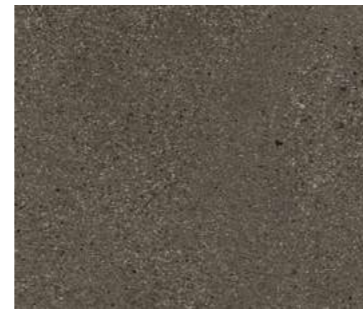

1772 Camino Dark Grey



0088 Oxyd Pure



1769 Tela Denim

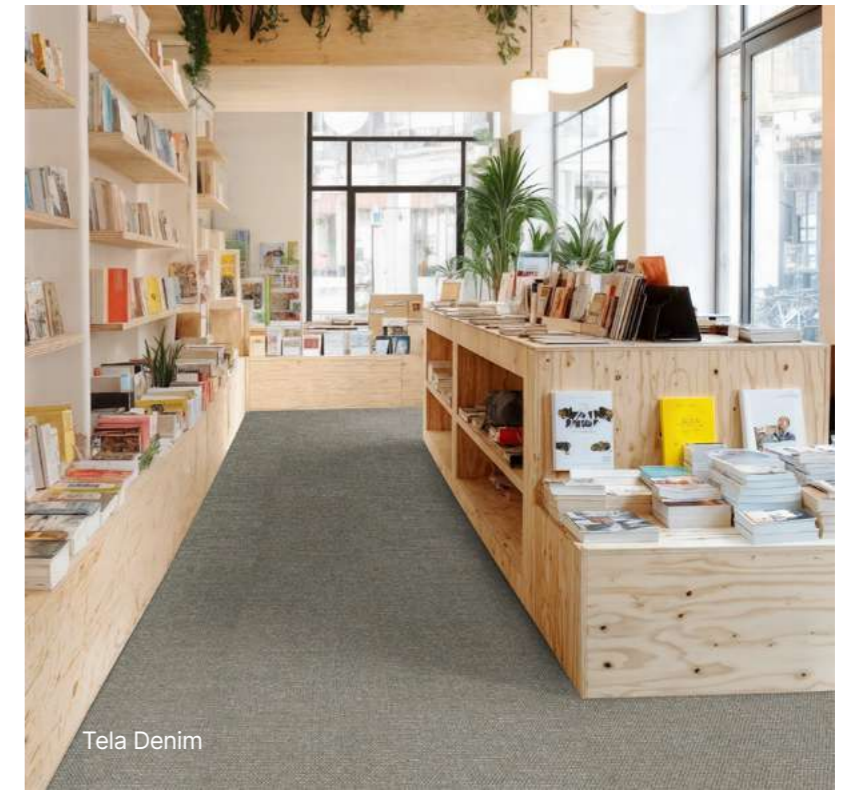

Tela Denim

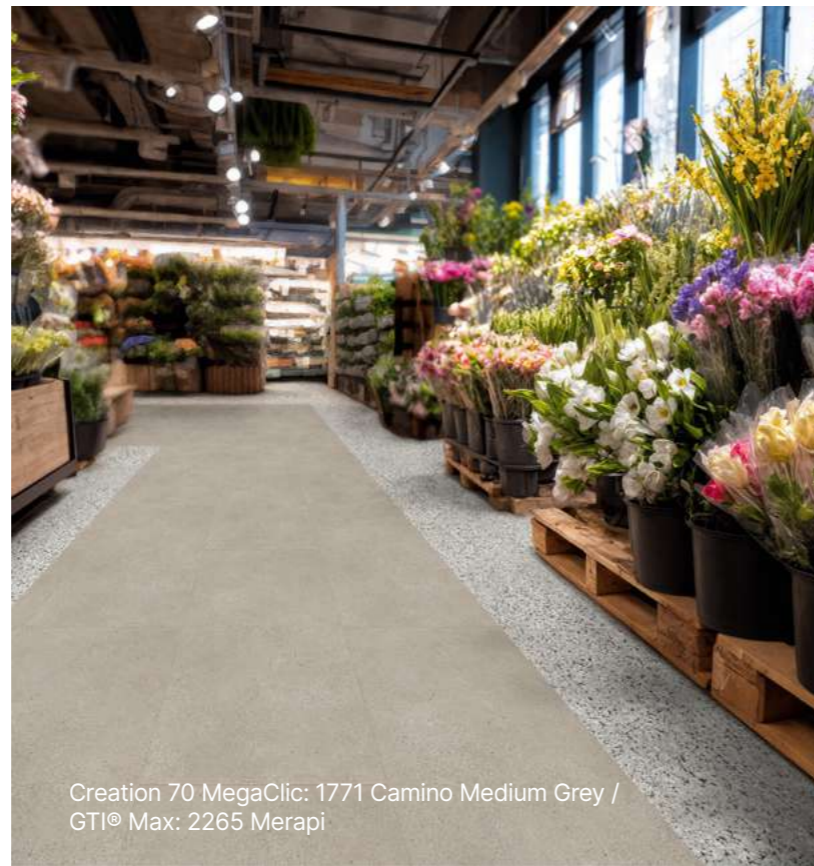

Creation 70 MegaClic: 1771 Camino Medium Grey / GTI® Max: 2265 Merapi



1768 Rapolano Light Beige



1773 Shady Concrete Grey



0085 Dock Grey



1069 Etna Dark



Prado



1064 Prado Green
Color scan scale: 1 / 5

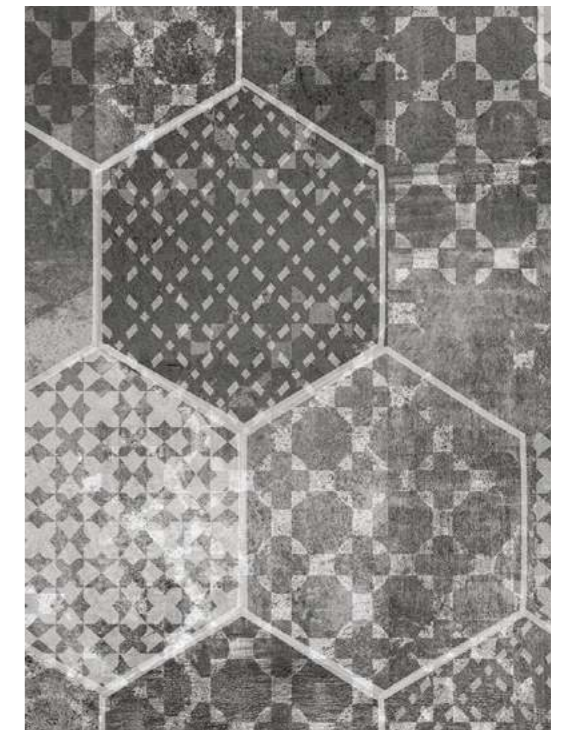

1774 Prado Grey
Color scan scale: 1 / 5



Creation Tiles & Planks

Creation 70 MegaClic **New**

we care / we act our commitments for 2030



Climate

Low CO₂ footprint / EPD available



Ressources

Recycled content 29% / Mineral & recycled content = 77%



Circularity

Adhesive free / easy re-cycle (Gerflor Second Life program)



Indoor air quality

Best-in-class performance A+ Certified & Floorscore



GTI® Max Carbon / Creation 70 MegaClic Albion

Full Design Concept



Aluminium Ramp
Code: 0505



PVC Ramp
Code: 0500
(colours: Lead, Linen)

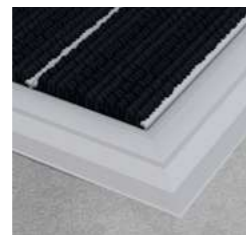

Entrance mat
Esplanade 9000
Code: 1700



Anti Bounce Mallet
Code: 5951



Welding rods CR50
Code: H009

Ultra Natural Look & Feel

More than 60% of our collection is using our new emboss technology - designed by our Artistic Team.



NEW

Scandinavian

A delicate surface, with a linear grain that accentuates the orientation of the material.



Brushed

The sensory expression of rustic wood, with a structured and random surface.



Hammered

A surface with a slightly grainy feel, where subtle irregularities evoke the authenticity of stone.



In addition to these ultra realistic embossing, Protecshield™ surface treatment offers a velvet touch, with a matt surface, ease of maintenance and micro scratch resistance.

Acoustic Design tiles and planks LVT*

Creation Zen

 A new generation of acoustic LVT from low to high traffic areas



High acoustic performance & comfort



Zen for the planet

- Made in France
- Recycled content** and 100% recyclable
- Lowest carbon footprint of all loose lay LVTs
- Phthalate-free*



Zen for the user

- Protecshield™ surface treatment, microscratch-resistant and easy to clean
- Acoustic insulation: 20 dB
- Better impact sound absorption: 65 dB

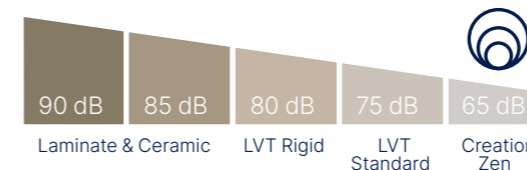

Zen for the installer

- Loose lay installation on to tackifier
- Flexible and lightweight to make cutting easier
- Replaceable: quick installation and removal

* Excluding recycled content
** Creation 55 Zen / Creation 70 Zen



Acoustic Design tiles and planks LVT

Creation 40/55/70 Zen

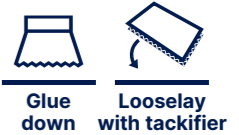

22 colors:
Creation 40 Zen

30 colors:
Creation 55/70 Zen



New designs

- 4 bevelled edges
- Available in 3 sizes
- MyCreation Zen custom designs available



New surface treatment

- Extra-matt appearance
- Micro-scratch-resistant
- Easy maintenance



The whole picture

- S0001 skirting board matches your floor or in plain white to paint and match other design elements in the room

Looselay installation with tackifier or glue down

Creation 40/55/70 Zen

CREATION 55 / 70 ZEN is an acoustic and decorative floor, in PVC multilayers reinforced with 2 fiber glass layers, available in tile and plank format, with 4 beveled edges. It has an antistatic abrasion group T, and R10 antislip performance. **CREATION 40 ZEN** is reinforced with a fiber veil.

CREATION 55 ZEN consists in a 0.55 mm thick transparent wear layer, the overall thickness is 4.25 mm. 0.70 mm / 4.35 mm for Creation 70 Zen. 0.40 mm / 3.60 mm for Creation 40 Zen.

The high density foam provides good **indentation resistance** of 0.12 mm. (average mesure) and **high acoustic insulation level** (-20dB).

CREATION 55/70 ZEN

Thanks to its double reinforcement, **fiber veil + fiber grid**, and to a **calendared intermediate layer** which gives it greater density, the coating retains its dimensional **stability** under the effect of a temperature variation (<0.03%).

It benefits from a cross-linked polyurethane surface treatment (**Protecshield™**) for making maintenance easier and prevent from micro-scratches.

CREATION 40 ZEN is 23/32 according to EN-ISO 10874 (residential / commercial use).

CREATION 70 ZEN is 34/42 according to EN-ISO 10874 (commercial / industrial use).

CREATION 55 ZEN is resistant to high traffic (commercial / industrial use) 33/42 according to EN-ISO 10874 and has Bfl-s1 class for smoke emission according to EN 13501-1.

CREATION ZEN is a looselay product, maintained with tackifier.

This installation allows, among other things, an installation on asbestos-contaminated support, and is removable.

CREATION 55/70 ZEN: 23% recycled content and **phthalate free** plasticizers (excepted recycled content). It is 100% recyclable and 100% compliant with REACH.

Creation 40 Zen

- ① ProtecShield™
- ② Transparent wearlayer
- ③ Printed design
- ④ Reinforced fiber veil
- ⑤ Compact interlayer
- ⑥ Very High Density foam

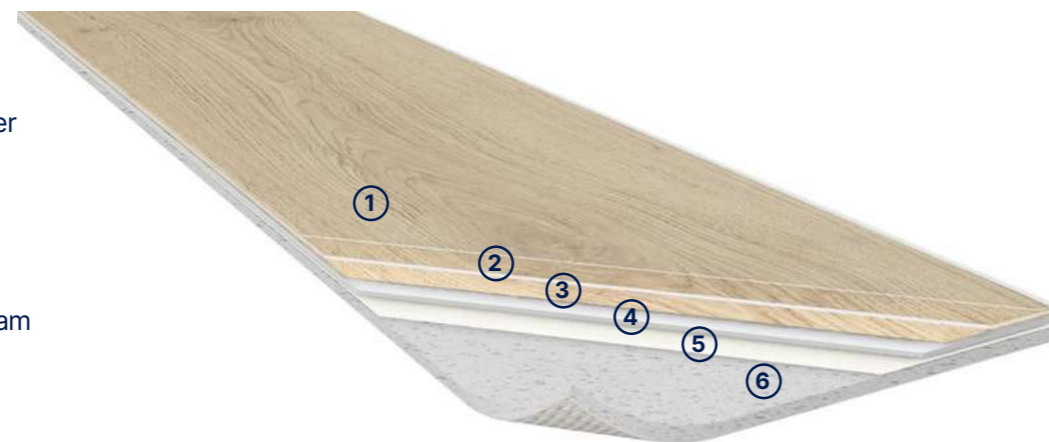

Creation 40 Zen

- An **aesthetic & economical solution** for homes
- ✓ Integrated acoustic layer: **20 dB**

Creation 55 Zen Creation 70 Zen

- An exclusive, **eco-designed** solution for **quick installation** in high-traffic locations
- ✓ **23% recycled content**
- ✓ 2 reinforcements = improved stability
- ✓ integrated acoustic layer: **20 dB**

Creation 55/70 Zen

- ① ProtecShield™
- ② Cristal wearlayer
- ③ Printed design
- ④ Fiber veil
- ⑤ Compact layer
- ⑥ Fiber grid
- ⑦ Calandered layer with recycled PVC
- ⑧ Acoustic resilient foam

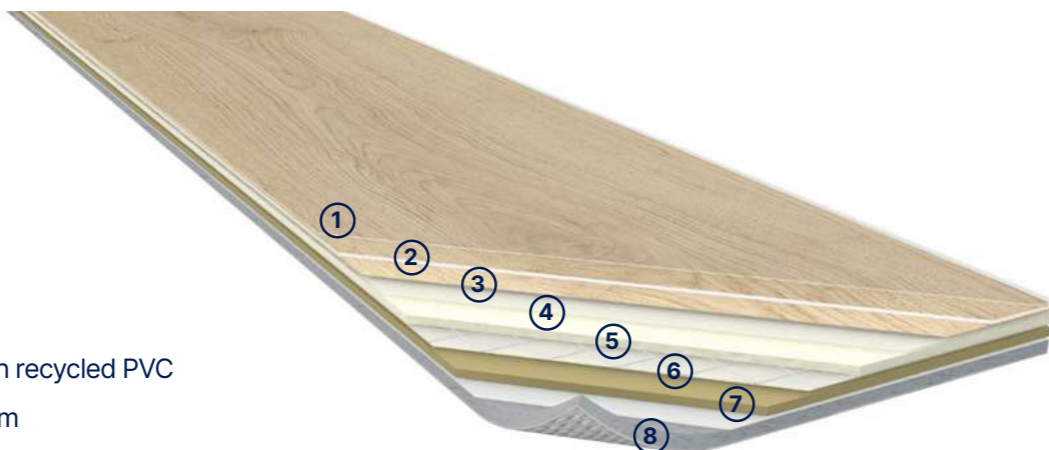

Nature Oak Taupe

**MADE
& RECYCLED
IN FRANCE**

Acoustic Design tiles and planks LVT

Creation 40/55/70 Zen

Formats details on page 176

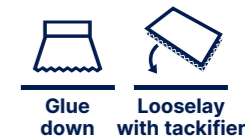

Nature Oak



1480 Nature Oak Honey

C40 Zen
C55 Zen
C70 Zen



1479 Nature Oak Kraft

C40 Zen
C55 Zen
C70 Zen



1481 Nature Oak Taupe

C40 Zen
C55 Zen
C70 Zen



Nature Oak Kraft

Bostonian Oak



1416 Bostonian Oak Beige

C40 Zen
C55 Zen
C70 Zen



1478 Bostonian Oak Kraft

C40 Zen
C55 Zen
C70 Zen



1415 Bostonian Oak

C40 Zen
C55 Zen
C70 Zen



1422 Bostonian Oak Medium

C40 Zen
C55 Zen
C70 Zen

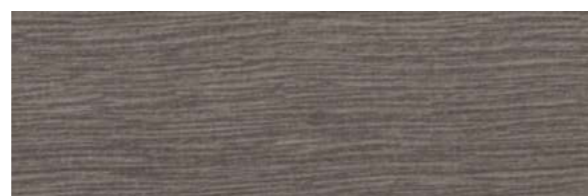

1421 Bostonian Oak Dark

C40 Zen
C55 Zen
C70 Zen

Swiss Oak



1418 Swiss Oak Beige

C40 Zen
C55 Zen
C70 Zen



1419 Swiss Oak Golden

C40 Zen
C55 Zen
C70 Zen



1420 Swiss Oak Pearl

C40 Zen
C55 Zen
C70 Zen



1417 Twist

C40 Zen
C55 Zen
C70 Zen

Ranch



0773 Ranch

C40 Zen
C55 Zen
C70 Zen



0953 Ranch Anthracite

C40 Zen
C55 Zen
C70 Zen



Swiss Oak Beige

Acoustic Design tiles and planks LVT

Creation 40/55/70 Zen

Formats details on page 176

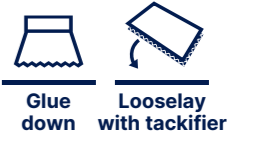

Bloom Uni



1484 Bloom Uni Brown
C55 Zen
C70 Zen



1412 Bloom Uni Taupe
C40 Zen
C55 Zen
C70 Zen



1482 Bloom Uni Clear
C55 Zen
C70 Zen



1413 Bloom Uni Grey
C40 Zen
C55 Zen
C70 Zen

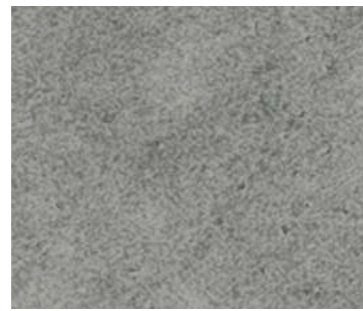

1485 Bloom Uni Souris
C40 Zen
C55 Zen
C70 Zen



0963 Bloom Uni Perle
C40 Zen
C55 Zen
C70 Zen

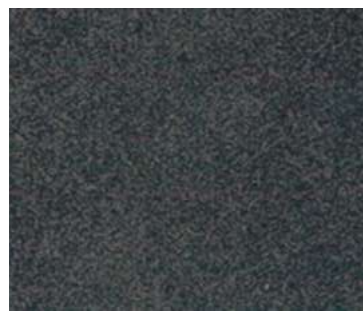

1483 Bloom Uni Black
C55 Zen
C70 Zen



Finesse Nature / Bloom Uni Taupe

Finesse



1064 Finesse Nature
C55 Zen
C70 Zen



1066 Finesse Poudre
C55 Zen
C70 Zen



1489 Finesse Grey
C40 Zen
C55 Zen
C70 Zen



1488 Finesse Denim
C55 Zen
C70 Zen



1063 Finesse Brown
C40 Zen
C55 Zen
C70 Zen

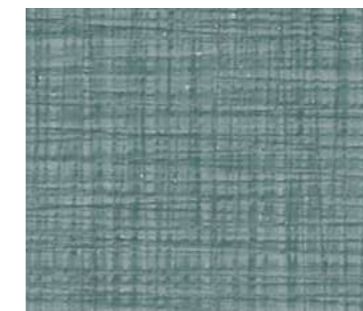

1487 Finesse Green
C55 Zen
C70 Zen



1414 Parker Station
C40 Zen
C55 Zen
C70 Zen



1486 Parker Clear
C40 Zen
C55 Zen
C70 Zen



Finesse Brown



0817 Cocoon Metal
C55 Zen
C70 Zen

Acoustic Design tiles and planks LVT

Creation 40/55/70 Zen

Code	Color Design	Creation 40 Zen	Creation 55 Zen	Creation 70 Zen	Skirting Matching Design	Coverstrip Matching Design	NCS	LRV
1483	Bloom Uni Black	*	500x500	500x500	-	C023	8000-N	5,8
1484	Bloom Uni Brown	*	500x500	500x500	-	-	5005-Y50R	22,3
1482	Bloom Uni Clear	*	500x500	500x500	-	-	3005-Y50R	45,1
1413	Bloom Uni Grey	500x500	500x500	500x500	S096	C016	5005-R50B	21,8
0963	Bloom Uni Perle	500x500	500x500	500x500	-	C017	3005-R20B	43
1485	Bloom Uni Souris	500x500	500x500	500x500	-	C016	4502-R	27,3
1412	Bloom Uni Taupe	500x500	500x500	500x500	S095	C019	4502-Y	27,7
1415	Bostonian Oak	245x1250	245x1250	245x1250	S016	C006	4010-Y50R	26,2
1416	Bostonian Oak Beige	245x1250	245x1250	245x1250	S017	C019	4005-Y50R	31,9
1421	Bostonian Oak Dark	245x1250	245x1250	245x1250	-	-	6005-Y80R	15
1478	Bostonian Oak Kraft	245x1250	245x1250	245x1250	S201	C002	3010-Y40R	36
1422	Bostonian Oak Medium	245x1250	245x1250	245x1250	-	-	6010-Y50R	15,6
0817	Cocoon Metal	*	500x500	500x500	-	-	4005-Y20R	34,7
1063	Finesse Brown	500x500	500x500	500x500	-	-	3010-Y50R	36
1488	Finesse Denim	*	500x500	500x500	-	-	5010-R90B	19,7
1487	Finesse Green	*	500x500	500x500	-	-	5010-B70G	20,7
1489	Finesse Grey	500x500	500x500	500x500	-	C019	4005-Y80R	29,5
1064	Finesse Nature	*	500x500	500x500	-	C019	3502-Y	37,6
1066	Finesse Poudre	*	500x500	500x500	-	-	3010-R10B	40,5
1480	Nature Oak Honey	245x1250	245x1250	245x1250	S192	C007	5010-Y30R	19,5
1479	Nature Oak Kraft	245x1250 150x750	245x1250 150x750	245x1250 150x750	-	C004	4010-Y30R	32,5
1481	Nature Oak Taupe	245x1250 150x750	245x1250 150x750	245x1250 150x750	-	C014	5005-Y50R	20,7
1486	Parker Clear	500x500	500x500	500x500	-	C019	4005-Y50R	29
1414	Parker Station	500x500	500x500	500x500	-	C015	6000-N	17,1
0773	Ranch	245x1250	245x1250	245x1250	S053	C014	5005-Y20R	25,3
0953	Ranch Anthracite	245x1250	245x1250	245x1250	-	-	6005-Y80R	16,4
1418	Swiss Oak Beige	245x1250	245x1250	245x1250	S011	B208	3010-Y50R	44,1
1419	Swiss Oak Golden	245x1250	245x1250	245x1250	S015	C003	4020-Y30R	26,4
1420	Swiss Oak Pearl	245x1250	245x1250	245x1250	S014	C010	3500-N	36,5
1417	Twist	245x1250	245x1250	245x1250	S039	C011	3010-Y50R	44

* Colour available on order, minimum quantity 700 m²

Packaging

Format (mm)	m ² /box	m ² /palett	Format (mm)	m ² /box	m ² /palett	Format (mm)	m ² /box	m ² /palett
Creation 40 Zen			Creation 55 Zen			Creation 70 Zen		
245 x 1250	4,29	192,9	245 x 1250	3,37	151,6	245 x 1250	3,37	151,6
150 x 750	4,28	179,6	150 x 750	3,49	146,5	150 x 750	3,49	146,5
500 x 500	4,5	234	500 x 500	3,75	195	500 x 500	3,75	195

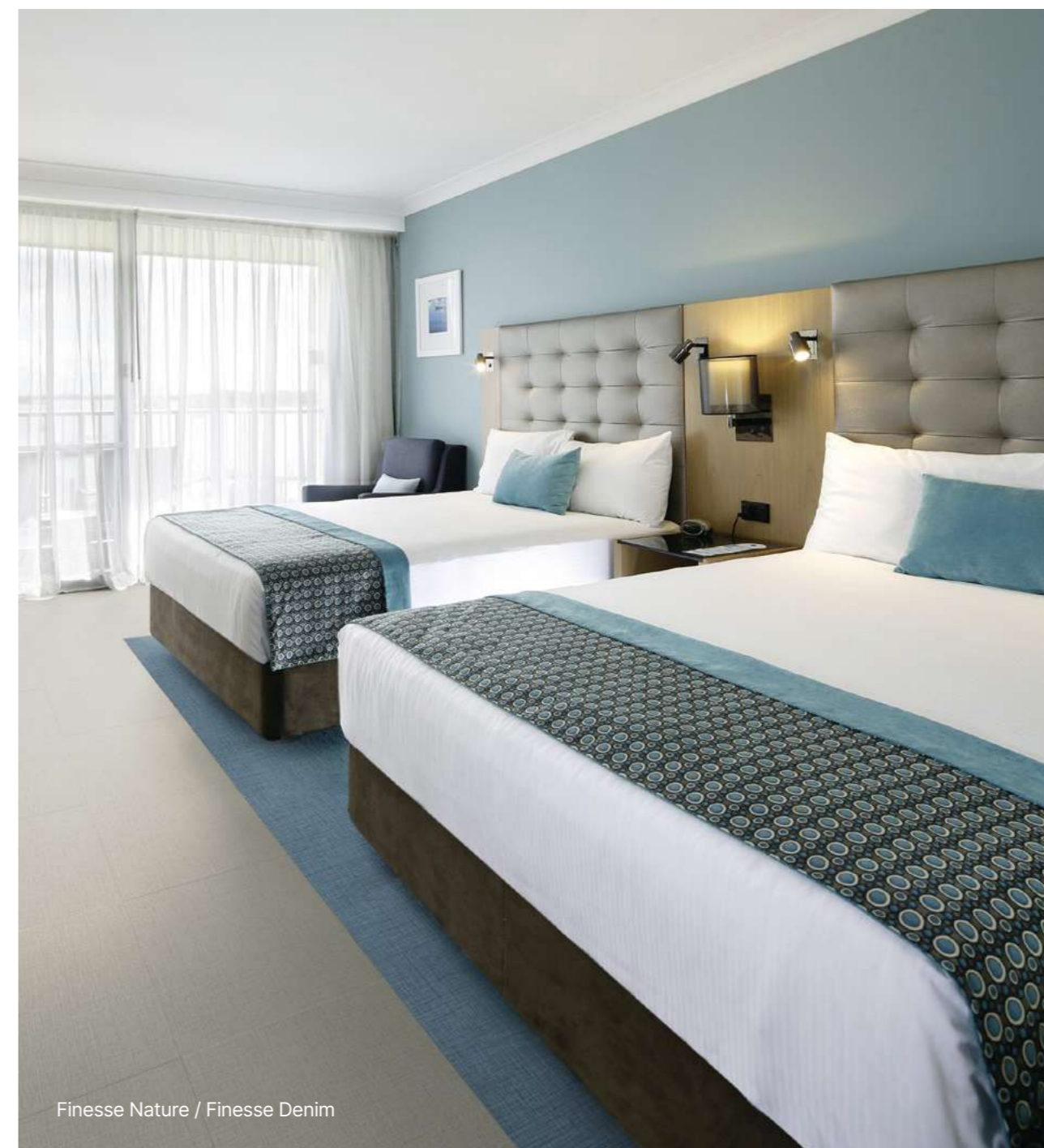

Finesse Nature / Finesse Denim

Creation Tiles & Planks

My Creation / My Creation Zen / My Saga²

Design your floor

As you are unique and each of your projects represents a new challenge, Gerflor gives you the chance to stand out, from 200 sqm.

One atmosphere, one style, one floor, but several possibilities...

My Creation _____

Available installations:

My Creation 70 Dry Back
My Creation 55 Dry Back

Available formats:

Plank: 184 × 1219 mm
XL Tile: 496 × 996 mm



My Creation Zen _____

Available formats:

Plank: 245 × 1250 mm et 150 × 750 mm
Tile: 500 × 500 mm



My Saga² _____

Available format:

Tile: 500 × 500 mm



My Creation, My Creation Zen and My Saga² collections are available on gerflor.com

Do not hesitate to contact your sales representative



3 Possibilities

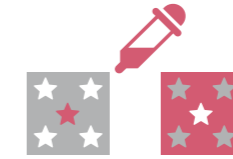

1 - Colour

Set the tone of your project by recolouring the design of your choice in our Creation or Creation Saga² ranges



2 - Collection

Leave a big impression on the atmosphere that you create thanks to our unique collection of 50 designs that reflect the major decorative trends that are popular today.
All of our customisable designs: myfloorbygerflor.com



3 - Customisation

Enhance the visual identity of your company or that of your clients by printing a logo and/or your own designs.

My Creation, My Creation Zen, My Saga²
Let's bring your inspiration to life together!

Creation Tiles & Planks

Technical data



			Creation 30	Creation 40	Creation 40 Clic	Creation 40 Clic Acoustic	Creation 55			Creation 55 Clic	Creation 55 Clic Acoustic	Creation 55 Looselay	Creation 55 Looselay Acoustic	Creation 40 Zen	Creation 55 Zen	Creation 70 Zen	
							Arte	Trend	Design								
Description																	
Total Thickness	EN ISO 24346	mm	2	2	4.50	5.50	2.50			5.00	6.00	4.50	5.50	3.60	4.25	4.35	
Thickness of the wearlayer	EN ISO 24340	mm	0.30	0.40	0.45	0.45	0.55			0.55	0.55	0.55	0.55	0.40	0.63	0.70	
Weight	EN ISO 23997	g/m ²	3460	3430	7118	7229	3850			7781	8024	9480	7500	7600	2675	3570	3670
Size	EN ISO 24342	mm	Plank - 184.15x1219.2 / 230x1500 Tile - 457.2x914.4 / 609.6x609.6	Plank - 184.15x1219.2 / 230x1500 Tile - 457.2x914.4	Plank - 212x1238.8 / 239.6x1460.8 Tile - 388.8x728.7	Plank - 212x1238.8 / 239.6x1460.8 Tile - 388.8x728.7	Plank - 184.15x1219.2 Tile - 496.5x996.5	Plank - 184.15x1219.2 / 230x1500 / 152.4x762 Tile - 457.2x914.4 / 609.6x609.6	Plank - 184.15x1219.2 (EIR) / 133.35x800.1 / 230x1500 (EIR) Tile - 609.6x609.6 / 914.4x914.4	Plank - 212x1238.8 / 239.6x1460.8 Tile - 388.8x728.7	Plank - 212x1238.8 / 239.6x1460.8 Tile - 388.8x728.7	Plank - 229x1220 / 152x914 Tile - 600x600 / 914x914	Plank - 228.6x1220 Tile - 600x600	Plank - 245x1250 / 150x750 Tile - 500x500	Plank - 245x1250 / 150x750 Tile - 500x500	Plank - 245x1250 / 150x750 Tile - 500x500	
Number of planks & tiles / sqm per box	-	-	15-11-9-9 / 3.36-3.80-3.76-3.35	21-13-11 / 4.71-4.49-4.6	8-7-7 / 2.10-2.45-1.98	8-6-7 / 2.10-2.10-1.98	15-8 / 3.36-3.96	15-9-33-9-9 / 3.36-3.11-3.82-3.76-3.35	15-30-9-9-5 / 3.36-3.20-3.11-3.35-4.18	7-6-6 / 1.84-2.10-1.70	7-5-6 / 1.84-1.75-1.70	16 / 1.5	6-12-6-4 / 1.67-1.67-2.16-3.34	8-6 / 2.23-2.16	14-38-18 / 4.29-4.28-4.50	11-31-15 / 3.37-3.49-3.75	11-31-15 / 3.37-3.49-3.75
Phthalate free	-	-	OK	OK	OK	OK	OK			OK	OK	OK	OK	OK	OK	OK	OK
Classification																	
Norm/Product Specification	-	-	EN ISO 10582	EN ISO 10582	EN ISO 10582	EN ISO 10582	EN ISO 10582			EN ISO 10582	EN ISO 10582	EN ISO 10582	ISO 10582	EN ISO 11638	EN ISO 11638	EN ISO 11638	
European Classification	EN ISO 10874	class	23-31	23-32-41	23-32-41	23-32-41	33-42			33-42	33-42	33-42	33-42	23-32	33-42	34-42	
Fire Rating	EN 13501-1	class	Bfl-s1	Bfl-s1	Bfl-s1	Bfl-s1	Bfl-s1			Bfl-s1	Bfl-s1	Bfl-s1	Bfl-s1	Bfl-s1	Bfl-s1	Bfl-s1	
Static Electrical Propensity	EN 1815	kV	< 2	< 2	< 2	< 2	< 2			< 2	< 2	< 2	< 2	< 2	< 2	< 2	
Slip Resistance Wet	DIN 51 130	class	R10	R10	R10	R10	R10			R10	R10	R10	R10	R10	R10	R10	
Performances																	
Wear Resistance	EN 660.2	mm ³	≤ 2.0	≤ 2.0	≤ 2.0	≤ 2.0	≤ 2.0			≤ 2.0	≤ 2.0	≤ 2.0	≤ 2.0	< 2.0	< 2.0	< 2.0	
Wear Group	-	-	T	T	T	T	T			T	T	T	T	T	T	T	
Type Binder content	EN ISO 10582	type	I	I	I	I	I			I	I	I	I	I	I	I	
Dimensional stability (norm)	EN ISO 23999	%	≤ 0.25	≤ 0.25	≤ 0.15	≤ 0.15	≤ 0.25			≤ 0.15	≤ 0.15	≤ 0.15	≤ 0.15	≤ 0.25	≤ 0.25	≤ 0.25	
Dimensional stability (average measured value)	-	%	≈ 0.10	≈ 0.10	≈ 0.05	≈ 0.05	≈ 0.10			≈ 0.05	≈ 0.05	≈ 0.05	≈ 0.05	≈ 0.05	≈ 0.03	≈ 0.03	
Impact sound insulation	EN ISO 717-2	dB	4	4	4	19	4			4	19	7	19	20	20	20	
Room Impact	NF S 31 074	dB	77	77	79	79	77			79	79	74	70				
Residual indentation (norm)	EN ISO 24343-1	mm	-	-	-	-	-			-	-	≤ 0.10	≤ 0.10	≤ 0.20	≤ 0.20	≤ 0.20	
Residual indentation (average measured value)	EN ISO 24343-1	mm	-	-	-	-	-			-	-	-	-	0.12	0.12	0.12	
Castor chair test (Type W)	ISO 4918	-	OK	OK	OK	OK	OK			OK	OK	OK	OK	OK	OK	OK	
Thermal Conductivity	EN ISO 10456	W/(m.k)	0.25	0.25	0.25	0.25	0.25			0.25	0.25	0.25	0.25	0.25	0.25	0.25	
Colour Fastness	EN 20 105-B02	degree	≥ 6	≥ 6	≥ 6	≥ 6	≥ 6			≥ 6	≥ 6	≥ 6	≥ 6	≥ 6	≥ 6	≥ 6	
Chemical Products Resistance	EN ISO 26987	-	OK	OK	OK	OK	OK			OK	OK	OK	OK	OK	OK	OK	
Surface Treatment	-	-	ProtecShield™	ProtecShield™	ProtecShield™	ProtecShield™	ProtecShield™			ProtecShield™	ProtecShield™	ProtecShield™	ProtecShield™	ProtecShield™	ProtecShield™	ProtecShield™	
Environment																	
Recycled content (average)	-	%	35	35	33	33	20	35	35	33	33	up to 35%	up to 35%	19	23	23	
Recyclability	-	%	100	100	100	100	100	100	100	100	100	100	100	100	100	100	
EPD	-	-	-	-	available	available	available			available	available	available	available	available	available	available	
Health																	
TVOC after 28 days	ISO 16000-6	micrograms/m ³	< 10	< 10	< 10	< 10	< 10			< 10	< 10	< 10	< 10	< 10	< 10	< 10	
Floorscore®	-	-	OK	OK	OK	OK	OK			OK	OK	-	-	-	-	-	
SCS Global Certification	-	-	-	-	OK	OK	-			OK	OK	-	-	-	-	-	
CE Marking																	

CE EN 14041



Creation Tiles & Planks

Technical data

	Creation 70		Creation 70 Clic		Creation 70 LooseLay		Creation 70 MegaClic		Creation 70 Connect		Creation Saga²	
	Arte	Design										
Description												
Total Thickness	EN ISO 24346	mm	2.50	2.50	5.00	5.00	6.00	5.00	4.60			
Thickness of the wearlayer	EN ISO 24340	mm	0.70	0.70	0.70	0.70	0.70	0.70	0.70			
Weight	EN ISO 23997	g/m²	3960	4100	7670	8300	9230	8235	5595			
Size	EN ISO 24342	mm	Plank - 184.15×1219.2 / Tile - 496.5 × 996.5	Plank - 230 × 1500 / Tile - 457.2 × 914.4 / 609.6 × 609.6 / 914.4 × 914.4	Plank 212 × 1238.8 / 239.6 × 1460.8 Tile 388.8 × 728.7	Plank - 235×1505 228.6×1220 152.4×914.4 Tile - 600×600 / 914.4×914.4	Plank - 200.5 × 1235.5 Tile - 489 × 989	701.3×701.3	500×500			
Number of planks & tiles / sqm per box	-	-	15 - 8 / 3.37 - 3.96	9 - 9 - 9 - 5 / 3.11 - 3.76 - 3.35 - 4.18	7 - 6 - 6 / 1.84 - 2.10 - 1.70	4-6-12-4-4 / 1.41-1.67-1.67-1.44-3.34	6-4 / 1.49-1.93	20 / 9.83	10 / 2.5			
Phthalate free	-	-	OK	OK	OK	OK	OK	OK	OK			
Classification												
Norm/Product Specification	-	-	EN ISO 10582	EN ISO 10582	EN ISO 10582	EN ISO 10582	EN ISO 10582	EN ISO 10582	EN ISO 10582	EN ISO 10582	EN ISO 10582	EN 652
European Classification	EN ISO 10874	class	34-43	34-43	34-43	34-43	34-43	34-43	34-43	34-43	34-43	34-42
Fire Rating	EN 13501-1	class	Bfl-s1	Bfl-s1	Bfl-s1	Bfl-s1	Bfl-s1	Bfl-s1	Bfl-s1	Bfl-s1	Bfl-s1	Bfl-s1
Static Electrical Propensity	EN 1815	kV	< 2	< 2	< 2	< 2	< 2	< 2	< 2	< 2	< 2	< 2
Slip Resistance Wet	DIN 51 130	class	R10	R10	R10	R10	R10	R10	R10	R10	R10	R10
Performances												
Wear Resistance	EN 660.2	mm³	≤ 2.0	≤ 2.0	≤ 2.0	≤ 2.0	≤ 2.0	≤ 2.0	< 2.0	≤ 2.0	≤ 2.0	≤ 2.0
Wear Group	-	-	T	T	T	T	T	T	T	T	T	T
Type Binder content	EN ISO 10582	type	I	I	I	I	I	I	I	I	I	I
Dimensional stability (norm)	EN ISO 23999	%	≤ 0.25	≤ 0.25	≤ 0.15	≤ 0.15	≤ 0.15	≤ 0.15	≤ 0.15	≤ 0.15	≤ 0.15	≤ 0.15
Dimensional stability (average measured value)	-	%	≈ 0.10	≈ 0.10	≈ 0.05	≈ 0.05	-	-	-	-	≈ 0.05	≈ 0.05
Impact sound insulation	EN ISO 717-2	dB	4	4	4	7	5	5	15	5	5	15
Room Impact	NF S 31 074	dB	77	77	79	74	78	75	< 65	75	75	< 65
Residual indentation	EN ISO 24343-1	mm	≤ 0.10	≤ 0.10	≤ 0.10	≤ 0.10	≤ 0.10	≤ 0.10	≤ 0.10	≤ 0.10	≤ 0.10	< 0.13
Castor chair test (Type W)	ISO 4918	-	OK	OK	OK	OK	OK	OK	OK	OK	OK	OK
Thermal Conductivity	EN ISO 10456	W/(m.k)	0.25	0.25	0.25	0.25	0.25	0.25	0.25	0.25	0.25	0.25
Colour Fastness	EN 20 105-B02	degree	≥ 6	≥ 6	≥ 6	≥ 6	≥ 6	≥ 6	≥ 6	≥ 6	≥ 6	≥ 6
Chemical Products Resistance	EN ISO 26987	-	OK	OK	OK	OK	OK	OK	OK	OK	OK	OK
Surface Treatment	-	-	ProtecShield™	ProtecShield™	ProtecShield™	ProtecShield™	ProtecShield™	ProtecShield™	PUR+ Matt	ProtecShield™	ProtecShield™	ProtecShield™
Environment												
Recycled content (average)	-	%	20	35	33	jusqu'à 35%	29	29	25	29	29	25
Recyclability	-	%	100	100	100	100	100	100	100	100	100	100
EPD	-	-	available	available	available	available	available	available	available	available	available	available
Health												
TVOC after 28 days	ISO 16000-6	micrograms/m³	< 10	< 10	< 10	< 10	< 10	< 10	< 10	< 10	< 10	< 10
Indoor Air Comfort Gold. Floorscore®	-	-	OK	OK	OK	-	-	-	-	-	-	-
SCS Global Certification	-	-	-	-	-	-	-	-	Floorscore®	-	-	-
CE Marking												
 EN 14041												



Carpet Tiles

pages 184-195

188. **Armonia 400**

192. **Armonia 540** **New**

194. **Armonia 620**

Pile Weight (g/m²)
ISO 2424

620

520

400

⊖

Armonia 400

Armonia 620

Armonia 540
New

31

33

⊕

Wear Classification
EN 1307

Armonia 400

Armonia 400 - 100% Polypropylene

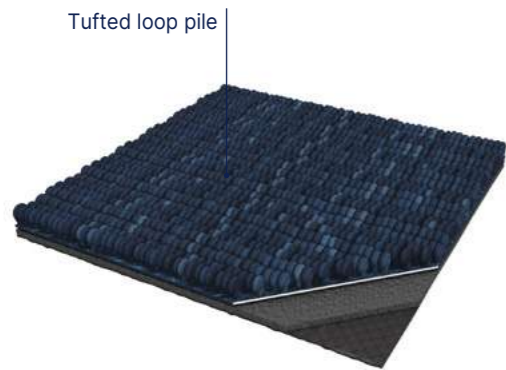

Armonia 400 is a decorative, reliable, hardwearing textile floor covering. It consists in a tufted 50 × 50 cm loop pile carpet tile with a 2,3 mm pile height. The overall thickness is 5,3 mm with 400 pile weight.

Armonia 400 is a 100% Polypropylene solution carpet tile with Bfl-s1 free floating on cement class for smoke emission according to EN 13501-1.

Armonia 400 is REACH compliant. The product emission rate of organic compounds is < 100 micrograms/m³ (TVOC < 28 days – EN 16516).

B-connect is a glue-free installation solution for Armonia tiles. The self-adhesive connectors are repositionable. They do not leave any marks on the back of the tile and keep the substrate clean. This solution promotes the recycling of tiles and simplifies the installation of a new covering on the preserved substrate.

The B-connect connectors are pre-cut and delivered in rolls of 200 connectors, covering approximately 50m² of Armonia tiles.



- **Easy mix with Gerflor collections** (Creation & Saga²)

- **Tile format** 500×500 mm

- **Light commercial use**

- **Indoor Air Quality**

TVOC <100µg/m³ (ISO 16516 - after 28 days)

- **Installation**

Monolithic or quarter-turn

- **Adhesive free possible**

with connectors (B connect)

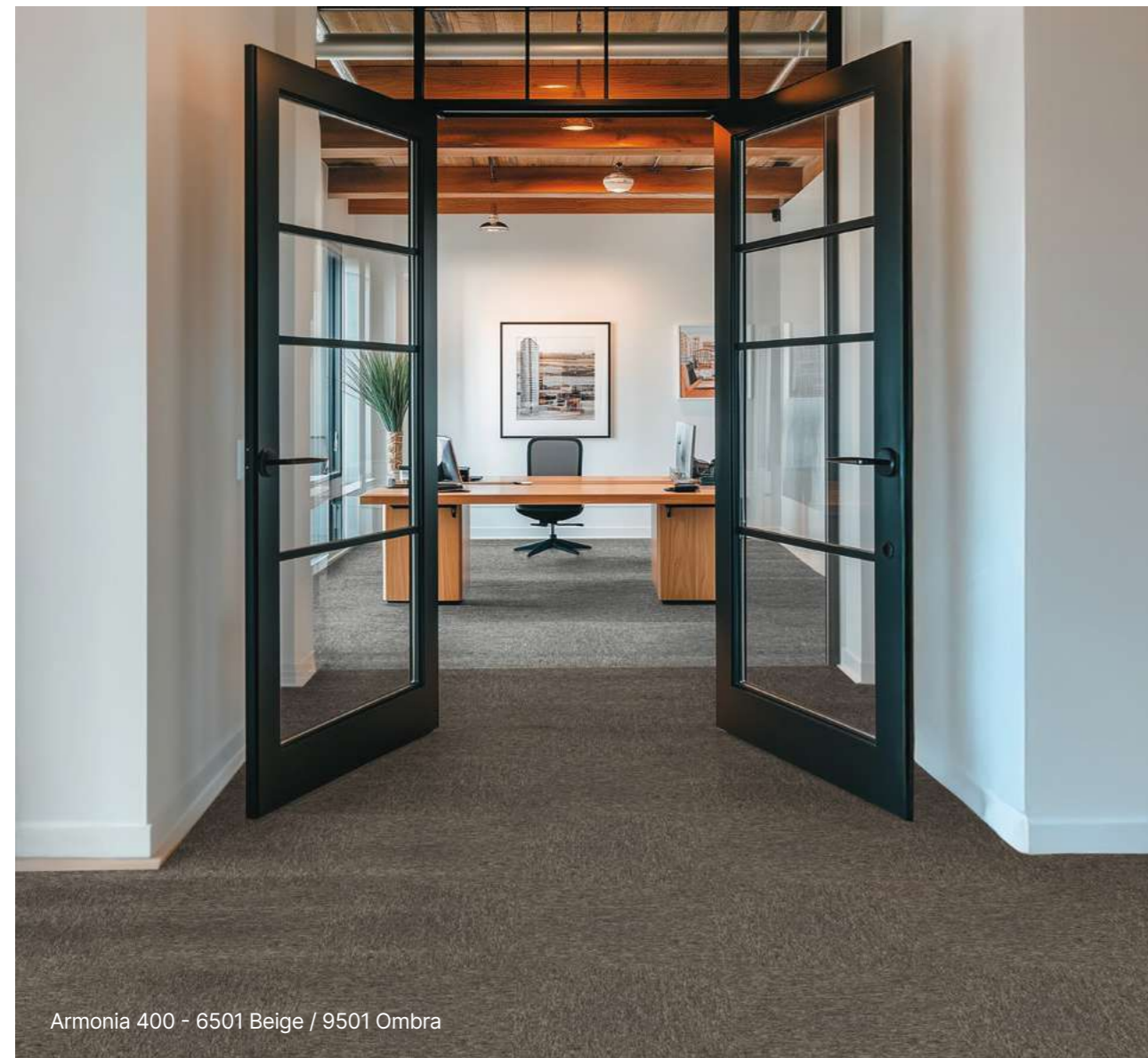

Armonia 400

Description			
Nature	ISO 2424	-	Loose-laid carpet tile
Construction	ISO 2424	-	Tufted loop pile
Pile Material	-	-	100% Polypropylene
Backing	ISO 2424	-	Bitumen
Gauge	ISO 1763	-	1/10
Pile Weight	ISO 2424	g/m ²	400
Surface Pile Weight	ISO 2424	g/m ²	240
Stitch Density	ISO 1763	tufts/m ²	145 800
Total Weight	ISO 8543	g/m ²	3790
Total Thickness	ISO 1765	mm	5.3
Pile Height	ISO 1766	mm	2.3
Size	ISO 24342	cm	50 × 50
Classification			
European Classification	EN 1307	class	31
Fire Rating	EN 13 501-1	class	Bfl-s1 affixed on cement
Static Electrical Propensity	ISO 6536	kV	≤2
Luxury Rating	EN 1307	class	LC1
Slip resistance	EN 13893	µ	≥0.3
Performances			
Dimensional Stability	EN 986	%	≤0.2
Thermal Resistance	ISO 8302	m ² C°/W	≤0,09 (0,0578)
Color Fastness	EN ISO 105 - B02	degree	≥6
Environment			
Recyclability	-	%	100
Health			
TVOC after 28 days	EN 16516	micrograms/m ³	≤100
Label GuT	n° GUT - Prodis		BFACFED8
CE Marking			
CE	EN 14041	-	

Packaging		
Tiles per Box	unit	24
Tiles per Box	m ²	6
Weight per Box	kg	22,96
Box per Pallet	unit	24
Pallet	m ²	144

Armonia 400

Comfort
500 x 500 mm

100% recyclable



6501 Beige

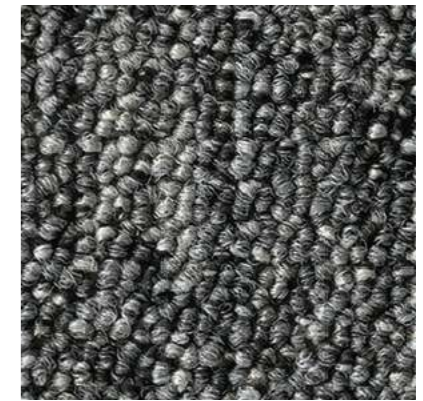

9501 Ombra

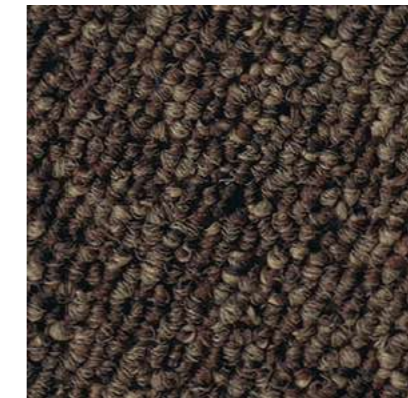

7801 Cacao



9701 Titanio



1801 Indigo



9901 Oxford

Scale 1

Creation 55 Looselay - 1559 Tamo Light / Armonia 400 - 7801 Cacao

Armonia 540 ^{New} & 620

Armonia 540 - Nylon - 540g/m²

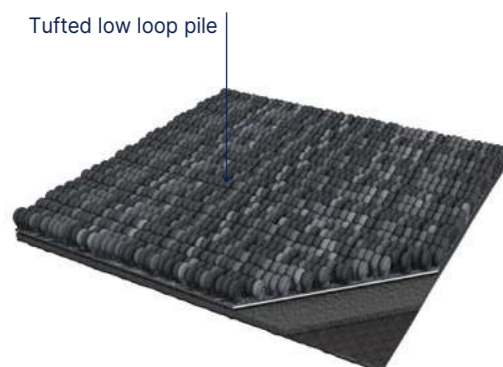

Armonia 540 is a decorative, reliable, hardwearing textile floor covering. It consists in a tufted 50 × 50 cm low loop pile carpet tile with a 2,3 mm pile height. The overall thickness is 5,5 mm with a 540 g/m² pile weight.

Armonia 540 is a 100% Nylon piece dyed carpet tile with resistance to use (commercial) of 33 according to EN 1307 and has Bfl-s1 free floating on cement class for smoke emission according to EN 13501-1.

Armonia 540 has an impact sound insulation of 24 dB according to the EN ISO 10140 and a noise reduction of 0.15 αw ISO 11654.

Armonia 540 is REACH compliant. The product emission rate of organic compounds is < 100 micrograms/m³ (TVOC < 28 days - EN 16516).

Armonia 620 - Econyl 100% recycled - 620g/m²

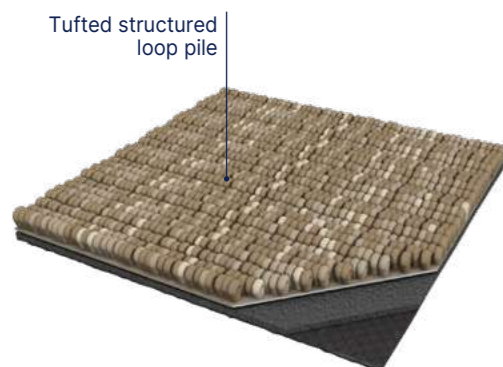

Armonia 620 is a decorative, reliable, hardwearing textile floor covering. It consists in a tufted 50 × 50 cm structured loop pile carpet tile with a 3,2 mm pile height. The overall thickness is 6,5 mm with 620 pile weight.

Armonia 620 is a 100% Nylon solution dyed carpet tile with resistance to use (commercial) of 33 according to EN 1307 and has Bfl-s1 free floating on cement class for smoke emission according to EN 13501-1.

Armonia 620 has an impact sound insulation of 24 dB according to the EN ISO 10140 and a noise reduction of 0.20 αw according to the ISO 11654.

Armonia 620 contents 15% of recycled content. It is REACH compliant. The product emission rate of organic compounds is < 100 micrograms/m³ (TVOC < 28 days - EN 16516).

B-connect is a glue-free installation solution for Armonia tiles. The self-adhesive connectors are repositionable. They do not leave any marks on the back of the tile and keep the substrate clean. This solution promotes the recycling of tiles and simplifies the installation of a new covering on the preserved substrate.

The B-connect connectors are pre-cut and delivered in rolls of 200 connectors, covering approximately 50m² of Armonia tiles.



Armonia 620 - 6103 Polvere



- For intensive commercial use
- Specific colours for perfect mix with Gerflor collections (Creation & Saga²)
- Tile format: 500×500 mm
- TVOC <100µg/m³ ⇒ indoor air quality (ISO 16516 - after 28 days)

- Installation monolithic or quarter-turn
- Adhesive free possible with connectors (B connect)
- Third part certified EPD

	Armonia 540		Armonia 620	
Description				
Nature	ISO 2424	-	Loose-laid carpet tile	Loose-laid carpet tile
Construction	ISO 2424	-	Tufted low loop pile	Tufted structured loop pile
Pile Material	-	-	100% Polyamide	100% Polyamide Econyl®
Backing	ISO 2424	-	Bitumen	Bitumen
Gauge	ISO 1763	-	1/10	1/10
Pile Weight	ISO 2424	g/m ²	540	620
Surface Pile Weight	ISO 2424	g/m ²	325	420
Stitch Density	ISO 1763	tufts/m ²	197 500	173 800
Total Weight	ISO 8543	g/m ²	3955	4105
Total Thickness	ISO 1765	mm	5.5	6.5
Pile Height	ISO 1766	mm	2.3	3.2
Size	ISO 24342	cm	50 × 50	50 × 50
Classification				
European Classification	EN 1307	class	33	33
Fire Rating	EN 13 501-1	class	Bfl-s1	Bfl-s1
Static Electrical Propensity	ISO 6536	kV	≤2	≤2
Luxury Rating	EN 1307	class	LC1	LC2
Slip resistance	EN 13893	µ	≥0.3	≥0.3
Performances				
Noise reduction	ISO 11654	αw	0.15	0.20
Impact Sound Insulation	ISO 140-8	dB	22	24
Dimensional Stability	EN 986	%	≤0.2	≤0.2
Castor Chair Test (type H)	ISO 4918	-	≥2.4	≥2.4 (Class A)
Thermal Resistance	ISO 8302	m ² C°/W	< 0.09 (0.0545)	<0.09 (0,0726)
Color Fastness	EN ISO 105 - B02	degree	>7/8	>7/8
Environment				
Recyclability	-	%	100	100
Health				
TVOC after 28 days	EN 16516	micrograms/m ³	≤100	≤100
Label GuT	n° GUT - Prodis	-	7FDF1AC0	BAEA3BAE
EPD	-	-	Available	Available
CE Marking				
CE	EN 14041	-		

Packaging		Armonia 540	Armonia 620
Tiles per Box	unit	24	20
Tiles per Box	m ²	6	5
Weight per Box	kg	24,34	20,89
Box per Pallet	unit	20	20
Pallet	m ²	120	100

Armonia 540 **New**



1795 Grafite

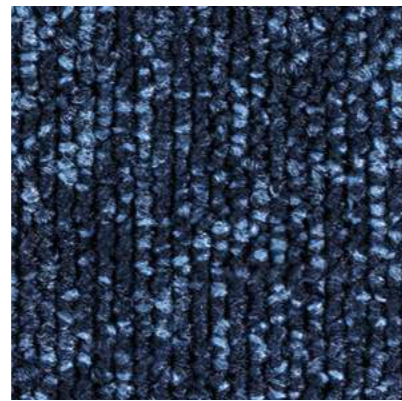

1796 Oceano

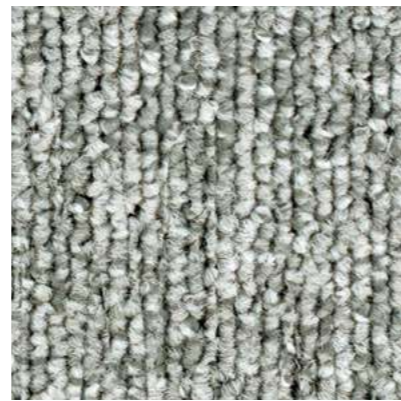

1798 Celeste



1792 Perla



1791 Talpa

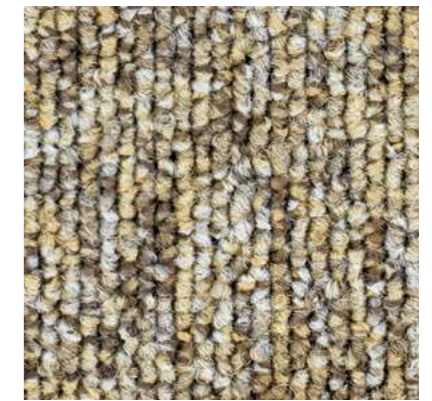

1790 Canapa



1793 Ferro



1797 Marino



1794 Platino

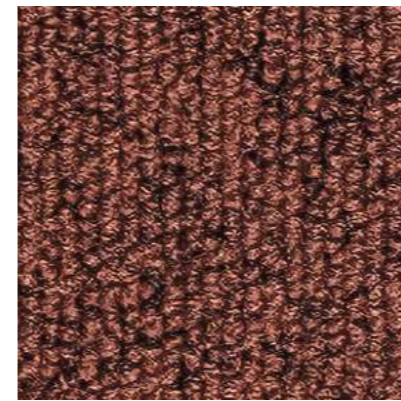

1801 Corallo



1802 Toscano



1803 Ambra



Armonia 540 - 1794 Platino



1800 Foglia



1799 Bosco

Scale 1

Armonia 620



6103 Polvere



9203 Nuvola



6273 Argilla



2173 Salvia



9303 Piombo



9503 Antracite

Scale 1



Wall Solutions

pages 196-211

198. Wall panels & tiles

- 198. Mural Revela **New**
- 204. Mural Revela accessories **New**

206. Wall coverings

- 208. Mural Ultra Design
- 210. Mural Club
- Mural Calypso
(See page 252)

Wall panels & tiles

Mural Revela New

Mural Revela

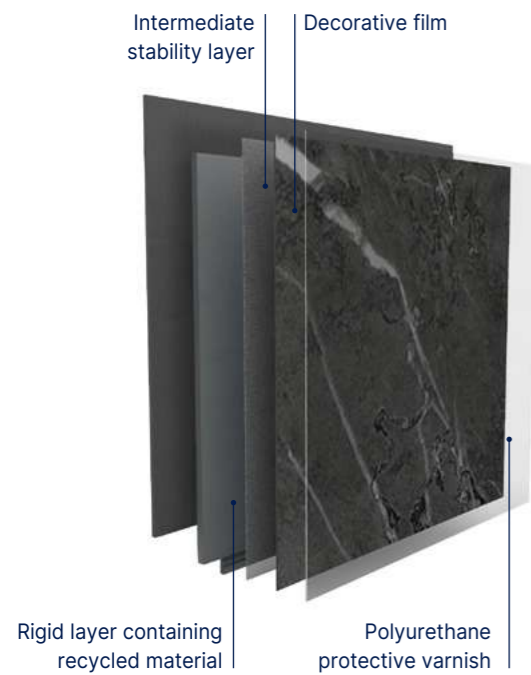

MURAL REVELA is a rigid vinyl wall covering which has a thickness of 5mm for an extended durability. It is available in 2 formats of 65 × 37,5cm for tiles or 260 × 90cm / 260 × 120cm for panels. It is intended for indoor use.

Its non-porous conception, its tongue and groove assembly system combined with a glued installation give **MURAL REVELA** a water resistance allowing an installation in wet areas including showers. Thanks to its robust conception and the total thickness of the product, **MURAL REVELA** is an ideal solution for renovation on ceramic tiles.

It has a fire reaction classification D-s3,d0 according to EN13501. It has excellent chemical resistance according to EN 423. It will be CMR 1 & 2 free and 100% Reach compliant. TVOC 28-day air emissions (NF EN 16000-6) will be classified as A+ (best class) under French health labelling.

MURAL REVELA has been designed and is produced in Europe. **MURAL REVELA** contains up to 30% recycled and is 100% recyclable. It can be collected and recycled through the Gerflor Second Life programme (selected countries).



- Tile and XL/XXL panel sizes
- Groove/tongue assembly
- Suitable for new builds
- Refurbishment over existing ceramic tiles
- Easy and quick to install
- Water resistant
- Washable product
- Installation in shower and/or bathtub area

Mural Revela					
	Tile	XL Panel	XXL Panel		
Description					
Total thickness	EN ISO 24346	mm	5		
Weight	EN ISO 23997	g/sqm	Matt: 6750 / Gloss: 7500		
Size	NF EN ISO 24341	cm	65 × 37,5	90 × 260	120 × 260
Chanfrein	-	-	Oui	Non	Non
Phthalate free	-	-	OK		
Classification					
Product specification	-	-	EN 15 102		
Fire rating	EN 13501-1	class	D-s3,d0		
Performances					
Surface Treatment	-	-	OK		
Cleanability	EN 233	-	Washable and brushable		
Environment					
Recycled content (average)	-	%	25		
Recyclability	-	%	100		
EPD	-	-	Available		
Health					
TVOC after 28 days	ISO 16516	µg/ m³	<100		
CE marking					
			EN 15102	OK DOP 036-2001-8	

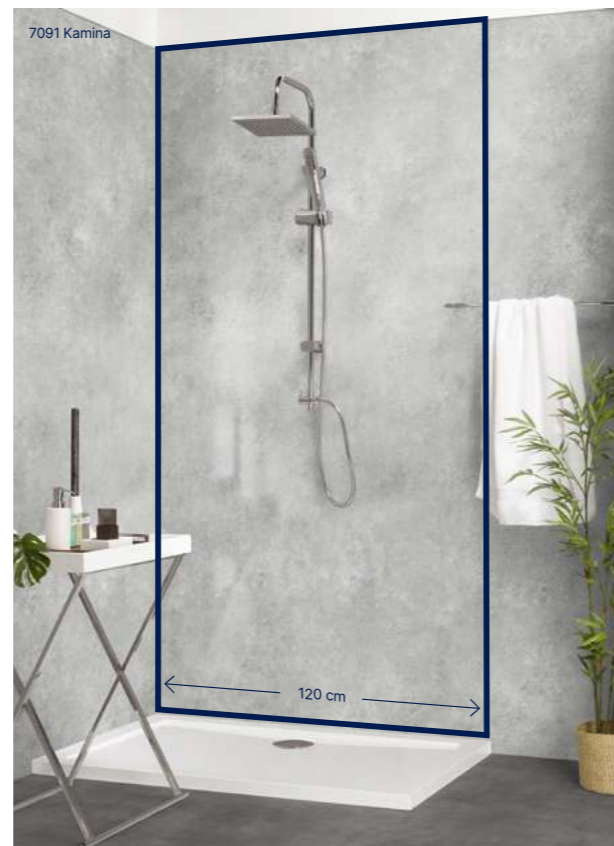

Wall panels & tiles

Mural Revela **New**

 Tile 65 x 37,5 cm |
  XL Panel 90 x 260 cm /
  XXL Panel 120 x 260 cm |
  100% recyclable



7029 Tanami Gloss

^ Scale 1

 65 x 37,5 cm |
  90 x 260 cm /
  120 x 260 cm



7868 Ubeda

 65 x 37,5 cm |
  90 x 260 cm /
  120 x 260 cm





7097 Boufia Gloss

 65 x 37,5 cm |
  90 x 260 cm



7053 Zanzibar

 65 x 37,5 cm |
  90 x 260 cm



Zanzibar

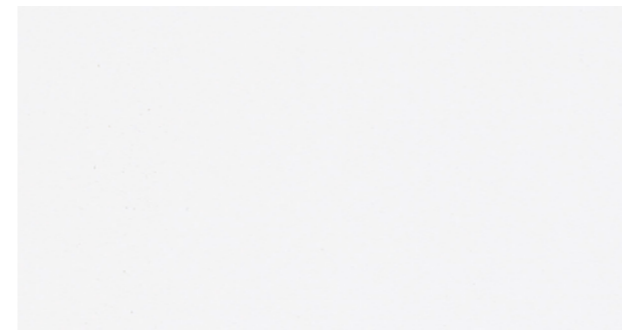

7918 Hanoi

 65 x 37,5 cm |
  90 x 260 cm



7035 Corabia

 65 x 37,5 cm |
  90 x 260 cm



7869 Baeza

 65 x 37,5 cm |
  90 x 260 cm



7032 Alanya

 65 x 37,5 cm |
  90 x 260 cm /
  120 x 260 cm



7059 Derby Gloss

 65 x 37,5 cm |
  90 x 260 cm



7007 Vilnius

 65 x 37,5 cm |
  90 x 260 cm



7072 Sarti

 65 x 37,5 cm |
  90 x 260 cm



7052 Colima

 65 x 37,5 cm |
  90 x 260 cm

Wall panels & tiles

Mural Revela **New**



7093 Ampara ^ Scale 1



7911 Liverpool



7091 Kamina



7915 Kampala



Perfect harmony between
Creation & Mural Revela

7 matching designs
Creation & Mural
Revela



7099 Marmor White



7100 Terrazzo Cobalt



7101 Concrete Clear



7095 Travertine Bone



7102 Concrete Cream



7098 Marbre Noir Gloss



7096 Wood Clear











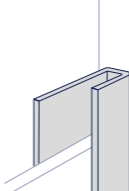



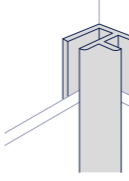



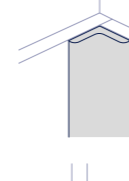

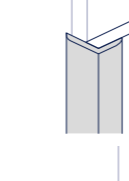

Wall panels & tiles

Mural Revela accessories **New**

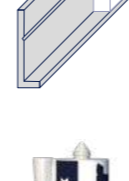

A complete solution with aluminum profiles for a perfect finish

	<p>U finishing trim Code: 0649 + color code</p>		Aluminium - 0001		Black - 0002		White - 0003
	<p>Universal angle Code: 0644 + color code</p>		Aluminium - 0001		Black - 0002		White - 0003
	<p>Internal angle Code: 0657 + color code</p>		Aluminium - 0001		Black - 0002		White - 0003
	<p>L-profile external angle Code: 0653 + color code</p>		Aluminium - 0001				
	<p>Click finishing profile Code: 0643 + color code</p>		Aluminium - 0001				
	<p>Start trim Code: 0652 + color code</p>		Aluminium - 0001				
	<p>New Revela Fix Code: 0633 MS Polymer White Glue 290 ML = ± 1.5m²</p>			<p>New Revela Joint Code: 0634 MS Polymer Crystal Sealant 290 ML = ± 8m² (tiles) ± 30m² (panel)</p>			

Full details on gerflor.com

Wall coverings

Mural Ultra Design / Mural Club / Mural Calypso

Mural Ultra Design

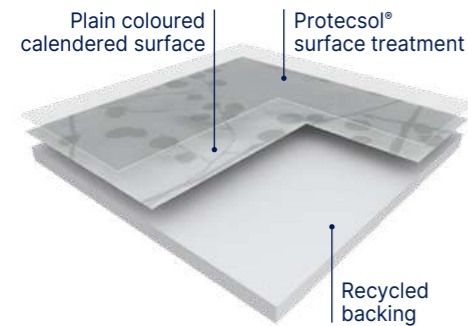

MURAL ULTRA DESIGN is a 2m width flexible wall covering vinyl sheet which has a thickness of 1.5mm for an extended durability. Fully resistant to impact (EN 259), **MURAL ULTRA DESIGN** acts as a buffer against damage from beds, trolleys, indoor motorized vehicles and other transportation systems. It is therefore ideal for use as a cladding in large public buildings such as hospitals, care institutions, dental and veterinary surgeries, schools, clean rooms, stores and supermarkets, warehouse and storage areas.

It is made of a 0.10mm printed design layer and a 1.4mm **coloured** resistance layer which will ensure a perfect welding aspect. It has a **B-s2,d0** fire classification (EN 13501-1) which complies with most European fire regulations.

According to ISO 22196, **MURAL ULTRA DESIGN** has anti-bacterial activity against E. coli, S. aureus and MRSA of 99% after 24h00. It is made of a coloured backing which comprises up to **30%** recycled products. It is 100 % recyclable, and the components are 100% compliant with Reach

MURAL ULTRA DESIGN benefits from the Protecsol® surface treatment which ensures easy maintenance (EN 233) and avoids staining of chemical products (EN ISO 26987) used in healthcare like iodine alcohol, Betadine, eosin and antibacterial hand gel. It is also resistant to decontamination (class 3 according to ISO 14644-1). The joints are hot-welded to ensure perfect water-tightness.

MURAL ULTRA DESIGN can be welded with 2mm flooring to ensure a perfect hygiene by avoiding gaps.

Mural Club

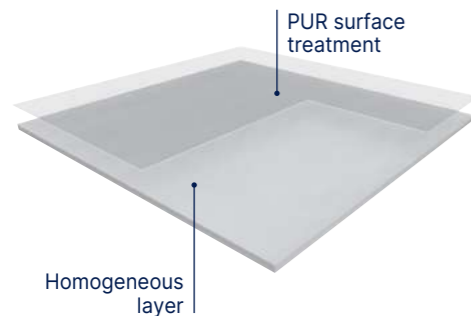

MURAL CLUB is a homogeneous wall covering in 2 m width roll and with a B-s2,d0 fire classification. It is designed to be a permanent wall covering. It is hot welded with CR40 welding rods for better hygiene. It is made of calendared layer with colour throughout the whole thickness for a nicer aspect of the welding. This layer comprises at least 10% of recycled products. It does not contain any CMR 1 & 2 component and is 100% compliant with REACH. It is 100% recyclable.

MURAL CLUB benefits from a **PUR** surface treatment which provides good resistance to chemical products and makes maintenance easier.

According to ISO 22196, **MURAL CLUB** has **anti-bacterial activity** against E. coli, S. aureus and MRSA of 99% after 24h. Full resistant to impact, it acts as a buffer against damage from beds, trolleys and indoor motorized vehicles and other transportation systems. **MURAL CLUB** is fully impact resistant and is therefore ideal for use as a cladding in large public buildings such as hospitals care institutions dental and veterinary surgeries, clean rooms, stores and supermarkets, warehouse and storage areas.

Mural Calypso

See page 252

- Easily seam welded to produce continuous surfaces.
- Create a safe and hygienic environment.
- Flexible and easy to cover.
- Ideal for walls and ceilings.
- Recyclable and Eco responsible.

			Mural Ultra Design	Mural Club	Mural Calypso
Description					
Total thickness	EN ISO 24346	mm	1.5	1.00	0.92
Thickness of transparent decorative layer	-	mm	0.10	-	0.10
Thickness of resistance layer	-	mm	1.4	1.00	-
Weight	EN ISO 23997	g/sqm	2450	1780	1610
Width/Length of sheet	EN ISO 24341	cm/ml	200 / 21	200 / 30	200 / 30
Phthalate free	-	-	OK	OK	OK
Classification					
Product specification	-	-	EN 259-1	EN 259-1	EN 259-1
Fire rating	EN 13501-1	class	B-s2,d0	B-s2,d0	B-s2,d0
Performances					
Colour fastness	EN ISO 105-B02	degree	≥ 6	≥ 6	≥ 6
Surface treatment	-	-	Protecsol®	PUR	-
Chemical products resistance ⁽¹⁾	EN ISO 26987	-	OK	OK	OK
Cleanability	EN 233		Washable and brushable	Washable and brushable	Washable and brushable
Emission of particles	ISO 14644-1	class	Class 3	-	-
Resistance to impacts	EN 259-2	-	No visible bursting or cracking	-	-
Scratch resistance	NF EN 14565 annex A	-	No visible deterioration	-	-
Determination of flexibility	EN ISO 24344	-	No damage, no cracking	-	-
Resistance of welded joints	EN 684	N/50mm	≥ 250	-	-
Environment					
Recycled content (average)	-	%	20	18	19
Recyclability	-	%	100	100	100
Health					
TVOC after 28 days	ISO 16516	µg/ m ³	<10	< 100	<100
Anti-bacterial activity (E. coli - S. aureus - MRSA) ⁽²⁾	ISO 22196	-	> 99% inhibits growth	> 99% inhibits growth	> 99% inhibits growth
CE marking					
			EN 15102	OK	

(1) Regarding the resistance to chemicals, please download the corresponding leaflet from our website.
 (2) The implementation of an effective cleaning regime is the most important defence against infection.

Wall coverings

Mural Ultra Design



Bs2d0

Protocols®



100% recyclable

IN STOCK



8408 Skyline
Ⓢ

^ Scale 1



8408 Skyline



8011 Lichen
Ⓢ



8744 Nordic Milk
Ⓢ



8309 Lotus
Ⓢ



8002 Bamboo Lotus
Ⓢ

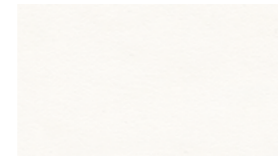

8611 Snow
Ⓢ



8000 Bamboo Snow Pearl
Ⓢ

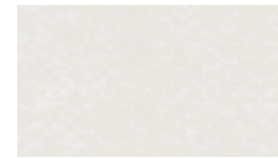

8711 Ice
Ⓢ



8740 Fabric Silk
Ⓢ



8721 Manhattan Mist
Ⓢ

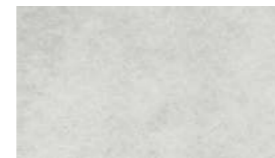

8010 Haze
Ⓢ



8005 Blossom Snow Pearl
Ⓢ

ON DEMAND

Minimum order quantity 500sqm



7025 Arty Beige
Ⓢ



7026 Arty Grey
Ⓢ



7311 Cloud Linen
Ⓢ



7017 Cloud Pink
Ⓢ



7019 Cloud Terra
Ⓢ



7201 Cloud Moonlight
Ⓢ



7022 Envol Snow Green*
Ⓢ



7023 Envol Snow Skyline*
Ⓢ



7013 Ginko Snow Gold*
Ⓢ



7014 Ginko Snow Green*
Ⓢ



7015 Tropic Skyline
Ⓢ



7016 Tropic Terra Copper
Ⓢ

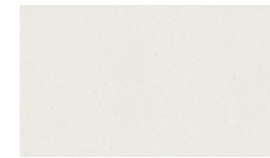

7020 Uni Ice
Ⓢ

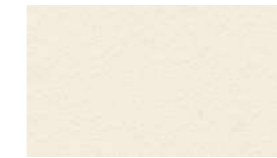

7021 Uni Lotus
Ⓢ



7027 Verona
Ⓢ



7024 Venice
Ⓢ

Wall coverings

Mural Club

 **PUR**  **100% recyclable**



0001 White



0005 Yellow  ^ Scale1



0006 Grey 

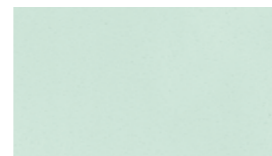

0004 Green 



0003 Sand 



0007 Blue 

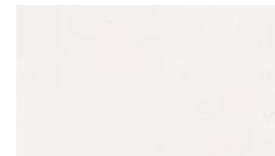

0001 White 

Mural Calypso (See page 252)

 **Bs2d0**  **100% recyclable**



7013 Ginko Snow Gold



Fast Track - High Traffic Tiles

pages 212-233

- 216. GTI®**
- 216. GTI® Max
- 216. GTI® Pure
- 220. GTI® EL5

224. Attraction®

230. Design tile

232. R-tile

Fast Track - High Traffic Tiles

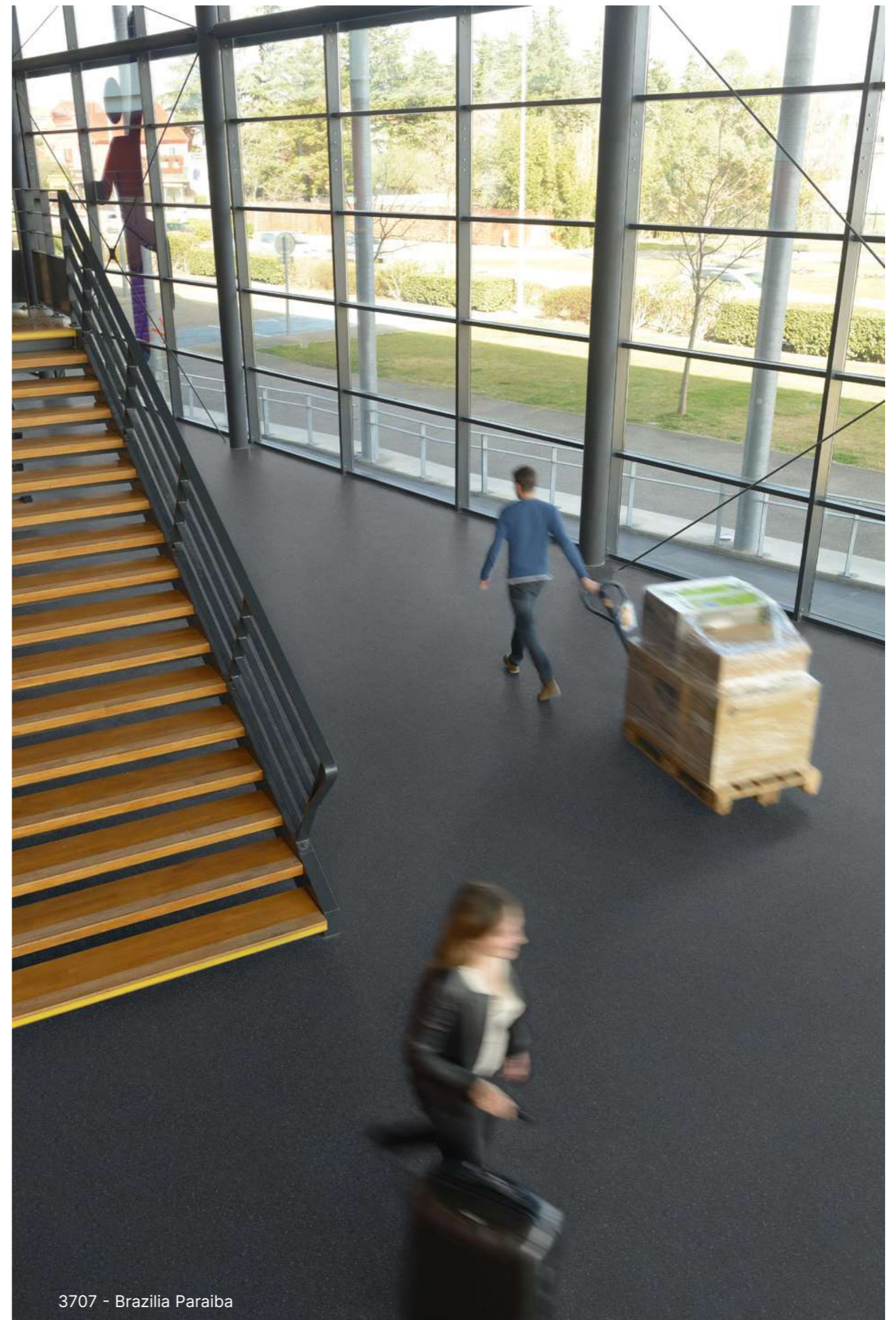
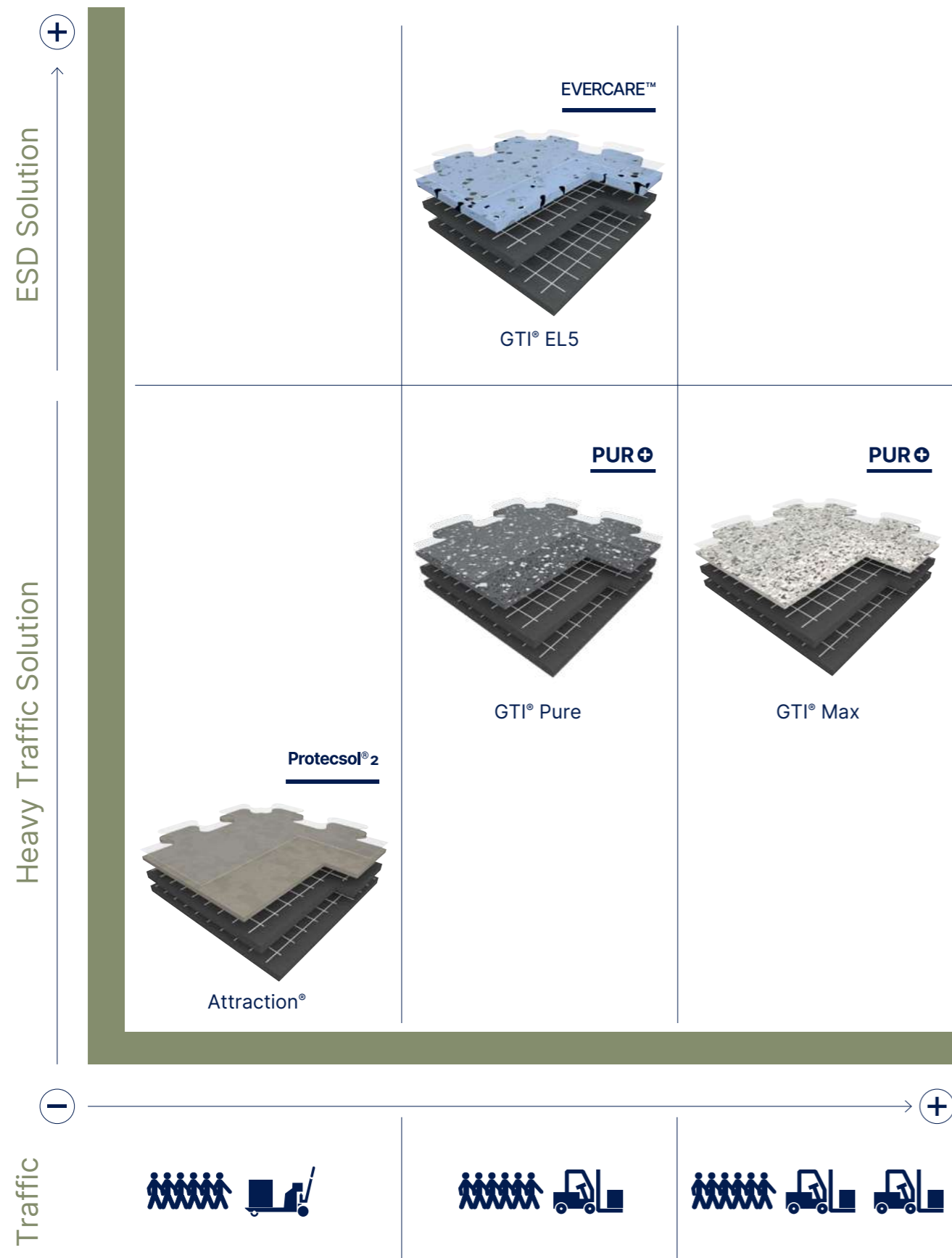

3707 - Brazilia Paraiba

Fast Track High Traffic Tiles

Fast Track - High Traffic Tiles

GTI® Max - GTI® Pure

GTI® Max Connect & Cleantech

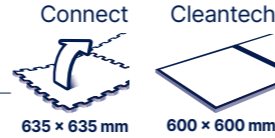

GTI® Max Connect

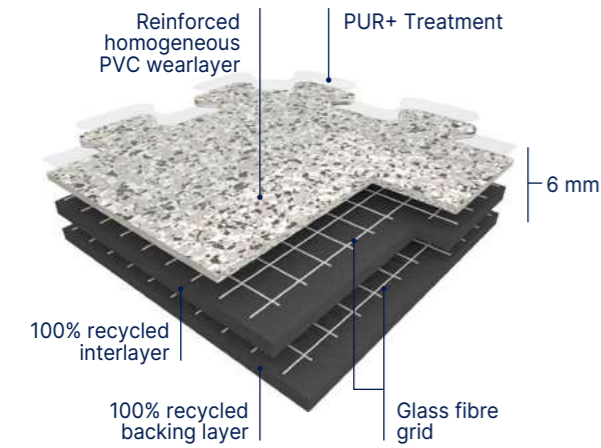

GTI® Max Cleantech

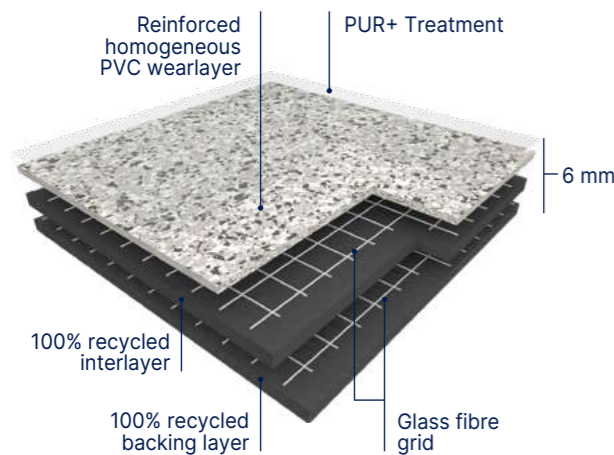

GTI® Pure Connect

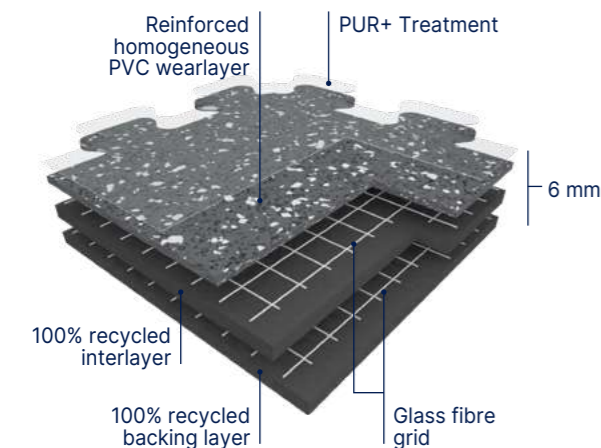

GTI® Max is a multi-layered interlocking looselay vinyl tile with polyurethane treatment (**PUR+**), 6 mm thick with a dovetail joint for the **Connect** configuration and with welded joints for the **Cleantech** configuration.

GTI® is manufactured by Gerflor using a continuous high pressure process, abrasion group T. The **GTI® Max** wearlayer is reinforced by specific oblong fillers that offers an outstanding resistance to traffic.

GTI® Max is reinforced with 2 glass fibre grids on either side of an intermediate pressed homogeneous layer.

GTI® Max backing is a 4 mm thick black pressed homogeneous sheet, its surface is a coloured and reinforced homogeneous sheet 2 mm thick. The product is 100% recyclable.

GTI® Max is made with a phthalate free plasticizer.

GTI® Access are ramps that provide continuity between the tile and the existing floor.

GTI® Corner enable covering of inaccessible corners or finishing central patterns.

GTI® Pure is a multi-layered interlocking looselay vinyl tile with polyurethane treatment (**PUR+**), 6 mm thick with a dovetail joint for the **Connect** configuration.

GTI® Pure is manufactured by Gerflor using a continuous high pressure process, abrasion group T. The **GTI® Pure** wearlayer is a Pure vinyl homogeneous wear layer with no filler, incorporating very densely pressed coloured chips and without any transparent wear layer. It offers an outstanding abrasion and scratch resistance and an high resistance to traffic.

GTI® Pure is reinforced with 2 glass fibre grids on either side of an intermediate pressed homogeneous layer.

GTI® Pure backing is a 5 mm thick black pressed homogeneous sheet, its surface is a colored and reinforced homogeneous sheet 1 mm thick. The product is 100% recyclable.

GTI® Pure is made with a phthalate free plasticizer.



- Resistant to heavy traffic
- Fast renovation: can be installed over existing floorcovering
- No subfloor preparation, no adhesive and no production stop (no loss of money)

- Polyurethane surface treatment **PUR+** for ease of maintenance
- 6 Standard logos: Mix and match colours to create corners and walkways

	GTI® Max		GTI® Pure	
Description				
Total thickness	EN ISO 24346	mm	6	6
Wearlayer thickness	EN ISO 24340	mm	2	1
Weight	EN ISO 23997	g/m ²	9365	8930
Size	EN ISO 24342	mm	635 × 635 Connect 600 × 600 Cleantech (without dovetail) ⁽¹⁾	635 × 635 Connect
Classification				
Norm / Product specification	-	-	EN ISO 10582	EN ISO 10582
European classification	EN ISO 10874	class	34-43	34-43
Fire rating	EN 13501-1	class	Bfl-s1	Bfl-s1
Static electrical propensity	EN 1815	kV	< 2	< 2
Slip resistance wet: ramp test with oil	EN 16165:2021 - Appendix B (DIN 51 130)	class	R10	R10
Pendulum test	BS7976	-	Concrete emboss ⁽²⁾ : +36 PTV	Rice emboss ⁽²⁾ : Soft emboss ⁽²⁾ -
Performances				
Wear resistance	EN 660.2	mm ³	≤ 2.0	≤ 2.0
Wear group	-	group	T	T
Type Binder content	EN ISO 10582	type	I	I
Dimensional stability	EN ISO 23999	%	≤ 0.15	≤ 0.15
Residual indentation	EN ISO 24343-1	mm	≤ 0.10	≤ 0.10
Castor chair test (type W)	ISO 4918	-	OK	OK
Shore Hardness	EN ISO 868	H _D	≥ 55	-
Shifting resistance	CAHIER CSTB 3562	N/mm ²	≥ 30	-
Thermal conductivity	EN ISO 10456	W/(m.k)	0.25	0.25
Colour fastness	EN ISO 105-B02	degree	≥ 6	≥ 6
Surface treatment	-	-	PUR+	PUR+
Chemical products resistance	EN ISO 26987	-	OK	OK
Environment				
Recycled content (average)	-	%	59	71
Recyclability	-	%	100	100
EPD	-	-	Available	Available
Health				
TVOC after 28 days	ISO 16000-6	microgram/m ³	< 10	< 10
Certification	-	-	Floorscore®	Floorscore®
CE marking				
CE	EN 14041			

(1) Available upon request

(2) +36 PTV only for 7 references GTI® Max: Ermelino - Ora - Bora - Libeccio - Grecale - Sirocco - Tramontana

GTI® LOGOS



0001 Caution 0002 Forklift 0006 Pedestrian 0003 Arrow 0005 No entry 0004 Stop

Fast Track - High Traffic Tiles

GTI® Max - GTI® Pure



Rice Emboss

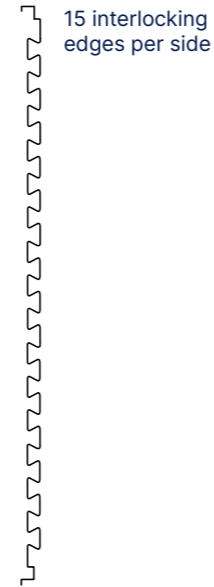
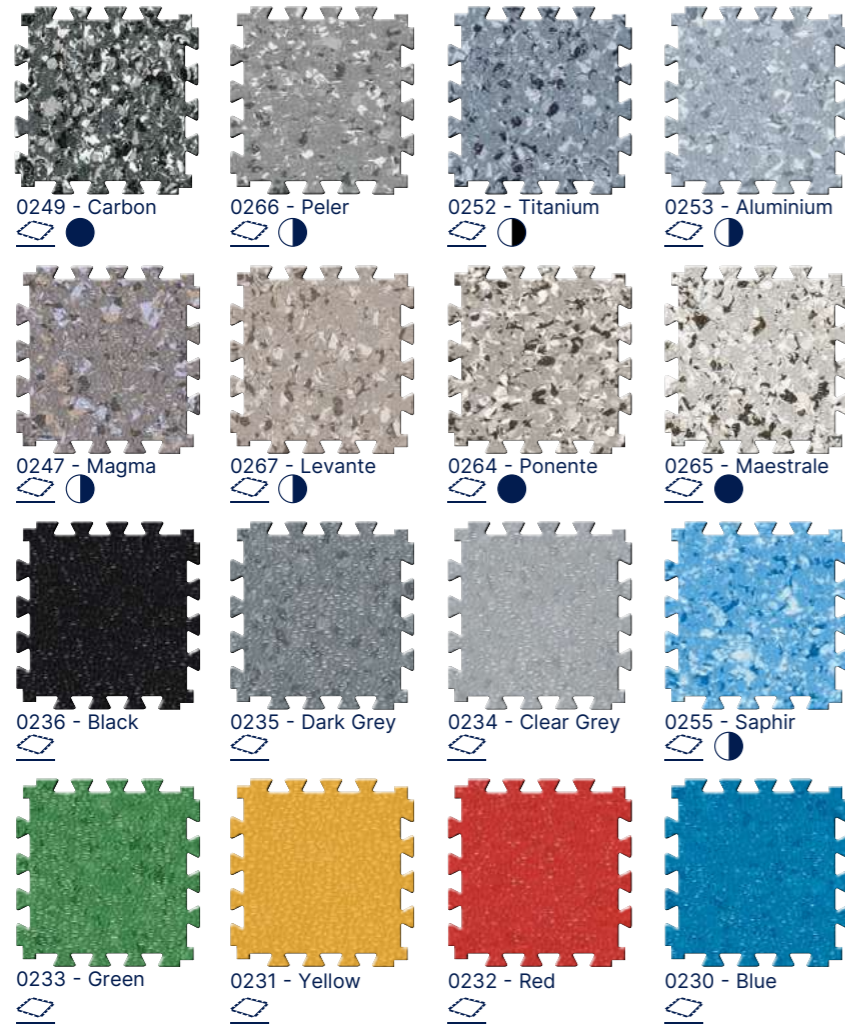

Concrete Emboss

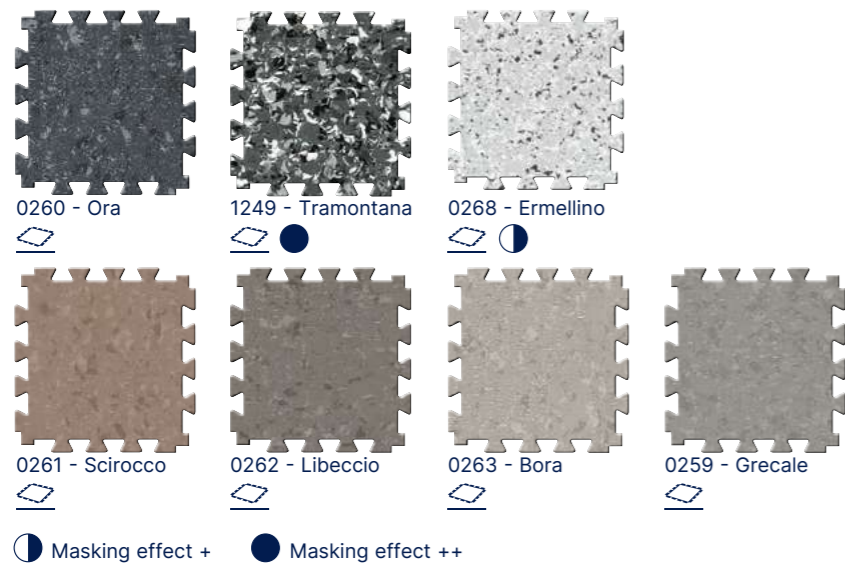

On order Moq: 500 sqm

All these colours are available in GTI® MAX CLEANTECH. For more details please contact your Gerflor representative.

GTI® Max - GTI® Pure



Soft Emboss*

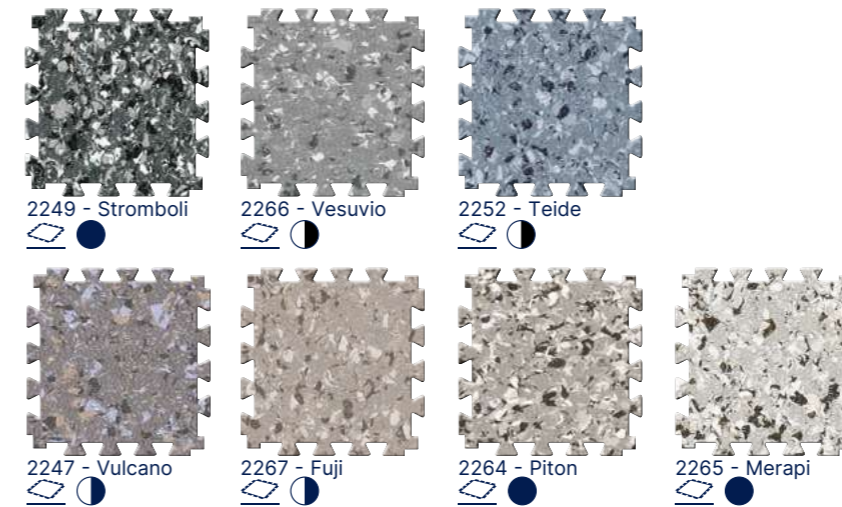

*On order Moq: 500 sqm

GTI® Pure



Soft Emboss*



*On order Moq: 500 sqm

● Masking effect + ● Masking effect ++

Accessories GTI® Max - GTI® Pure

Aluminium ramp 5-6 mm



Aluminium Ramp 5-6 mm / Ref. 0505 + Aluminium Corner 5-6 mm / Ref. 1513 See page 346

High traffic pvc Ramp 6 mm



Ref. 0500 See page 347

Entrance Mat for GTI®



Romat GT - Ref. 1719



Esplanade 9000 - Ref. 1700

Corner & Access



GTI® ACCESS 635 x 320 mm



GTI® CORNER 320 x 320 mm

For more information, please refer to our GTI® MAX brochure.

Fast Track - High Traffic Tiles

GTI® EL5

GTI® EL5 Connect & Cleantech

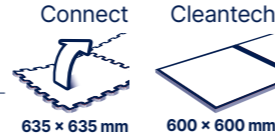

GTI® EL5 CONNECT

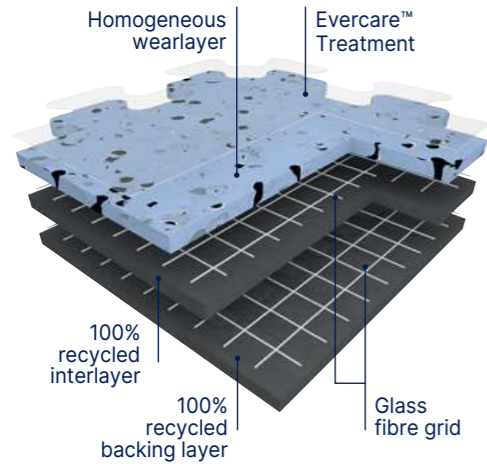

GTI® EL5 Connect is a multi-layered looselay vinyl tile, 6 mm thick, reinforced with 2 glass fibre grids. GTI® EL5 Connect tiles can be installed using interlocking system with dove tails.

GTI® EL5 Cleantech is a multi-layered looselay vinyl tile, 6 mm thick, reinforced with 2 glass fibre grids. GTI® EL5 Cleantech is available in **square format with welded joints** for clean environments and watertight systems requirements.

GTI® EL5 wearlayer is 2 mm vinyl homogeneous manufactured with continuous high pressure process, abrasion group P. It offers an outstanding resistance to traffic.

This floorcovering is treated with **Evercare™** technology: the latest improvements in polyurethane surface treatment obtained by UV laser cross-linking. Evercare™ offers **easy maintenance and resistance against staining** of chemical products used in healthcare like betadine, eosin or anti-bacterial hand gel; **and decontamination protocols.**

This treatment has excellent maintenance characteristics; it requires no wax for life!

The carbon encapsulated granules throughout its full thickness and the **conductive backing** and **conductive surface treatment** ensure optimal and consistent conductive properties throughout its full life expectancy.

• $5 \times 10^4 \leq Rt \leq 10^6$ according to **EN 1081**

It has permanent antistatic properties.

• **< 2000 V** according to **EN 1815**

The product is non-emissive of volatile organic compounds with < 10 microgram/m³ (TVOC after 28 days ISO 16000-6).

GTI® EL5 CLEANTECH

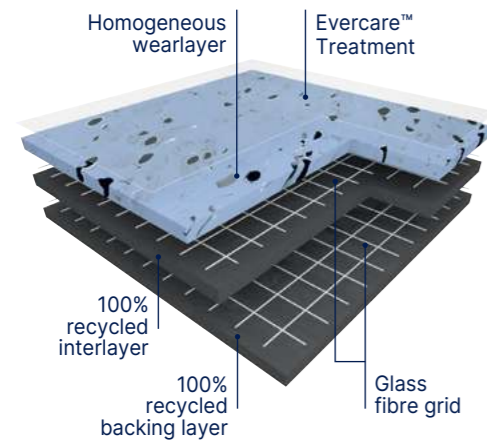

Complementary Finishes

GTI® EL5 Connect		GTI® EL5 Cleantech	
		2715	Access
2717	Access	2716	Corner
		2722	Conductive Welding Rods



Connect

- Fast Installation
- Resistance to heavy traffic

Cleantech

- Watertight System (hot welding)
- Resistance to heavy traffic

GTI® EL5

Description			
Total thickness	EN ISO 24346	mm	6
Wearlayer thickness	EN ISO 24340	mm	2
Weight	EN ISO 23997	g/m²	9240
Size	EN ISO 24342	mm	635 x 635 (Connect) 650 x 650 (Cleantech)
Classification			
Norm / Product specification	-	-	EN ISO 10582
European classification	EN ISO 10874	class	34-43
Fire rating	EN 13501-1	class	Bfl-s1
Electrical resistance ⁽¹⁾	EN 1081	Ohm	$5 \times 10^4 \leq Rt \leq 10^6$
Static electrical propensity	EN 1815	kV	< 2
Slip resistance wet: ramp test with oil	EN 16165:2021 - Appendix B (DIN 51 130)	class	R9
Performances			
Wear resistance	EN 660.2	mm³	≤ 4.0
Wear group	NF 189	group	P
Type Binder content	EN ISO 10582	type	I
Dimensional stability	EN ISO 23999	%	≤ 0.25
Castor chair test (type W)	ISO 4918	-	OK
Shore Hardness	EN ISO 868	H _b	≥ 90
Thermal conductivity	EN ISO 10456	W/(m.k)	0.25
Colour fastness	EN ISO 105-B02	degree	≥ 6
Surface treatment	-	-	Evercare™
Chemical products resistance	EN ISO 26987	-	OK
Environment			
Recycled content (average)	-	%	43
Recyclability	-	%	100
EPD	-	-	Available
Health			
TVOC after 28 days	ISO 16000-6	microgram/m³	< 10
Certification	-	-	Floorscore®
CE marking			



EN 14041

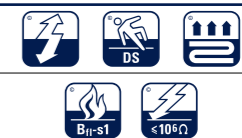

(1) Measured before installation



Fast Track - High Traffic Tiles

GTI® EL5



GTI® Cleantech - 0354 Blue

 **Removable R9 Evercare™**
Compact Connect
635 x 635 mm

GTI® EL5 CONNECT



635 x 635 mm

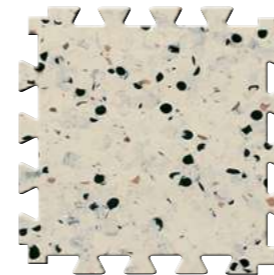

0353 Beige

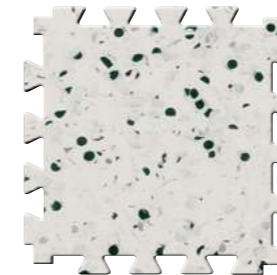

0350 Light Grey

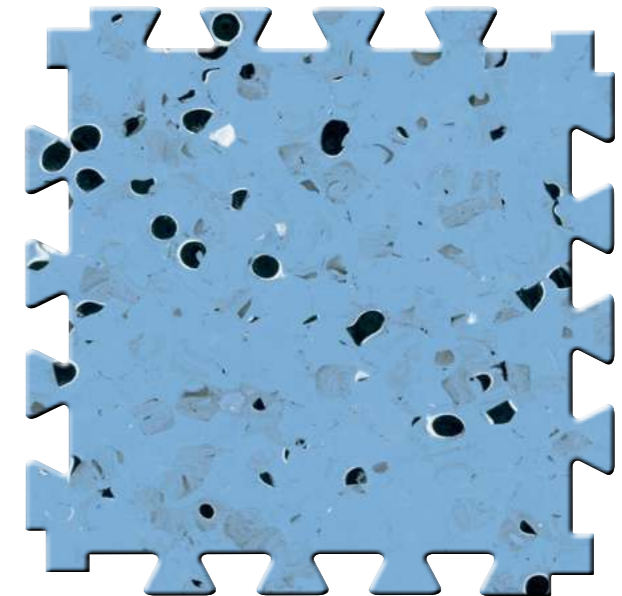

0354 Blue

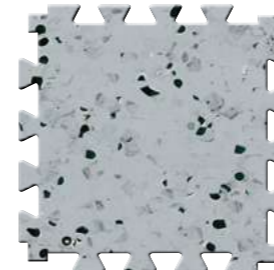

0352 Grey

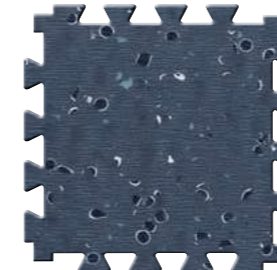

0351 Black

^ Scale 1

GTI® EL5 CLEANTECH

 **Removable R9 Evercare™**
Compact Cleantech
650 x 650 mm

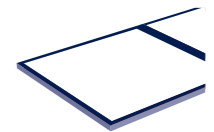

650 x 650 mm

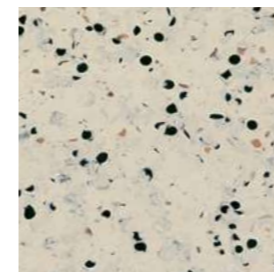

0353 Beige

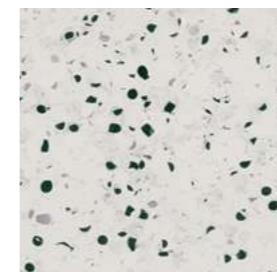

0350 Light Grey

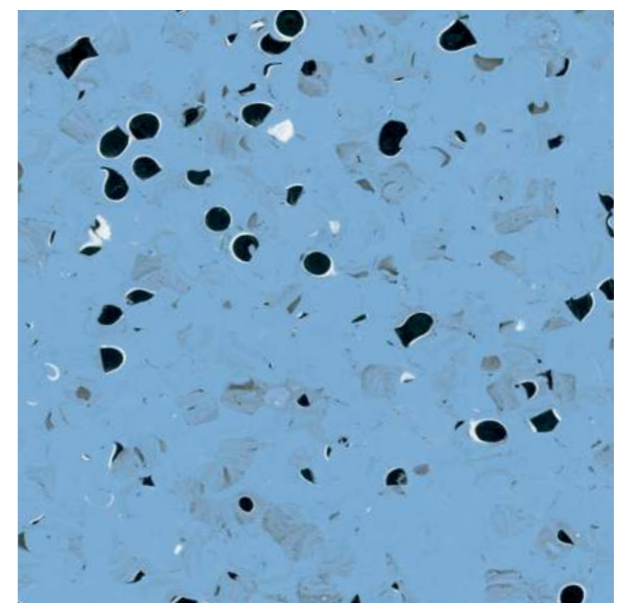

0354 Blue

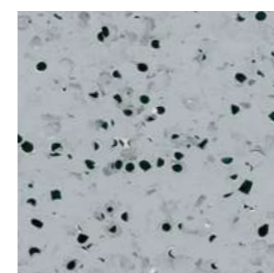

0352 Grey

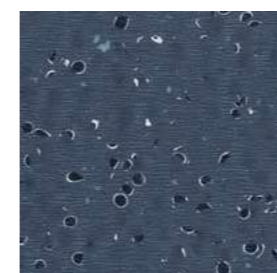

0351 Black

^ Scale 1

Fast Track - High Traffic Tiles

Attraction®

Attraction® Connect & Cleantech

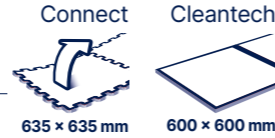

Attraction® connect

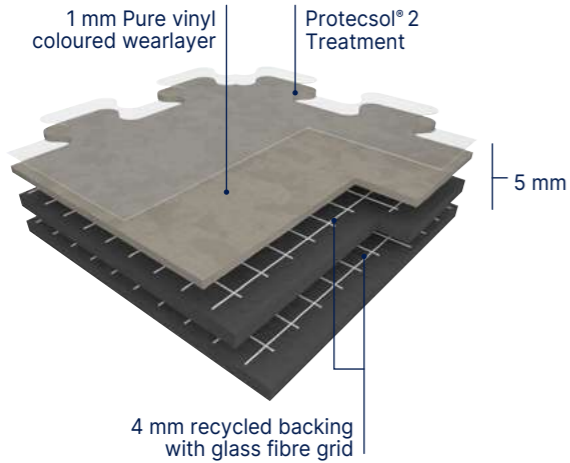

Attraction® is a semi-flexible tile constructed by compacting, at high temperature and over 3000 T, a 4 mm recycled backing and a 1 mm **Pure vinyl wear layer. This wear layer is incorporating very densely pressed coloured chips, with a mat finishing and without a transparent wear layer.** The product comprises a compact backing which is pressed and reinforced with two glass fibre grids.

Attraction® has a unique dovetail joint which allows fast loose lay installation and replacement.

Attraction® is treated with **Protecsol® 2**, a surface treatment obtained by UV laser crosslinking.

This **Protecsol® 2** ensures easy maintenance and eliminates permanently the need for acrylic emulsion (metallisation). It avoids staining of chemical products used in healthcare like iodine alcohol, Betadine, eosin and anti-bacterial hand gel.

It has a Bfl-s1 fire classification in accordance with standard EN 13501-1. The products emission rate of volatile organic compounds is **< 10 microgram/m³ (TVOC after 28 days – ISO 16000-6)**.

It is made with a phthalate free plasticizer.

It is made of 100% controlled recycled materials.

It does not contain any heavy metals or CMR 1&2 and they are 100% compliant with REACH.

It is 100% recyclable and made with up to 80% recycled content.

Attraction® cleantech

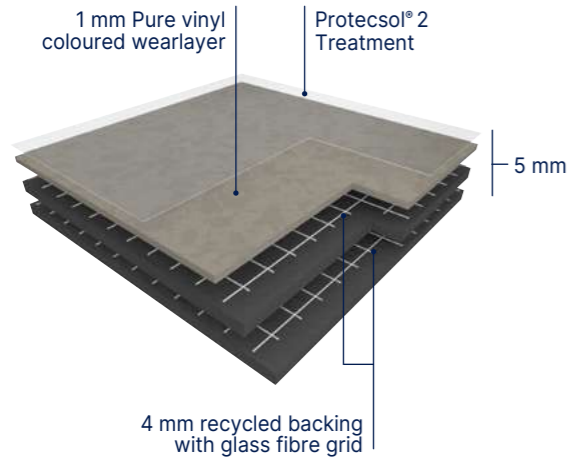

Attraction®



The Taralay Premium range in the looselay Attraction® format for an easy and longlasting renovation!

- Fast track and easy installation
- No immobilisation of the premises and no loss of turnover
- Little or no subfloor preparation
- Low maintenance cost: UV cured polyurethane Protecsol® 2 treatment

Attraction®			
Description			
Total thickness	EN ISO 24346	mm	5.00
Wearlayer thickness	EN ISO 24340	mm	1.00
Weight	EN ISO 23997	g/m²	7460
Size	EN ISO 24342	mm	635 × 635 Connect 600 × 600 Cleantech (without dovetail) ⁽¹⁾
Classification			
Norm / Product specification	-	-	EN ISO 10582
European classification	EN ISO 10874	class	34-43
Fire rating	EN 13501-1	class	Bfl-s1
Static electrical propensity	EN 1815 IEC 61340-4-5	kV V	< 2
Slip resistance wet: ramp test with oil	EN 16165:2021 – Appendix B (DIN 51 130)	class	R10
Performances			
Wear resistance	EN 660.2	mm³	≤ 2.0
Wear group	-	group	T
Type Binder content	EN ISO 10582	type	I
Dimensional stability	EN ISO 23999	%	≤ 0.15
Residual indentation	EN ISO 24343-1	mm	≤ 0.10
Castor chair test (type W)	ISO 4918	-	OK
Thermal conductivity	EN ISO 10456	W/(m.k)	0.25
Colour fastness	EN ISO 105-B02	degree	≥ 6
Surface treatment	-	-	Protecsol® 2
Chemical products resistance	EN ISO 26987	-	OK
Environment			
Recycled content (average)	-	%	69
Recyclability	-	%	100
EPD	-	-	Available
Health			
TVOC after 28 days	ISO 16000-6	microgram/m³	< 10
Certification	-	-	Floorscore®
Anti-bacterial activity (E. coli - S. aureus - MRSA) ⁽²⁾	ISO 22196	-	> 99 % inhibits growth / ne favorise pas la prolifération
Anti-viral activity (human coronavirus 229E)	ISO 21702	-	99.7% after 2h
CE marking			
CE		EN 14041	

(1) Available upon request.

(2) The implementation of an effective cleaning method is the best defence against infection.

Fast Track - High Traffic Tiles

Attraction®



Removable R10 Protecso!® 2

100% recyclable

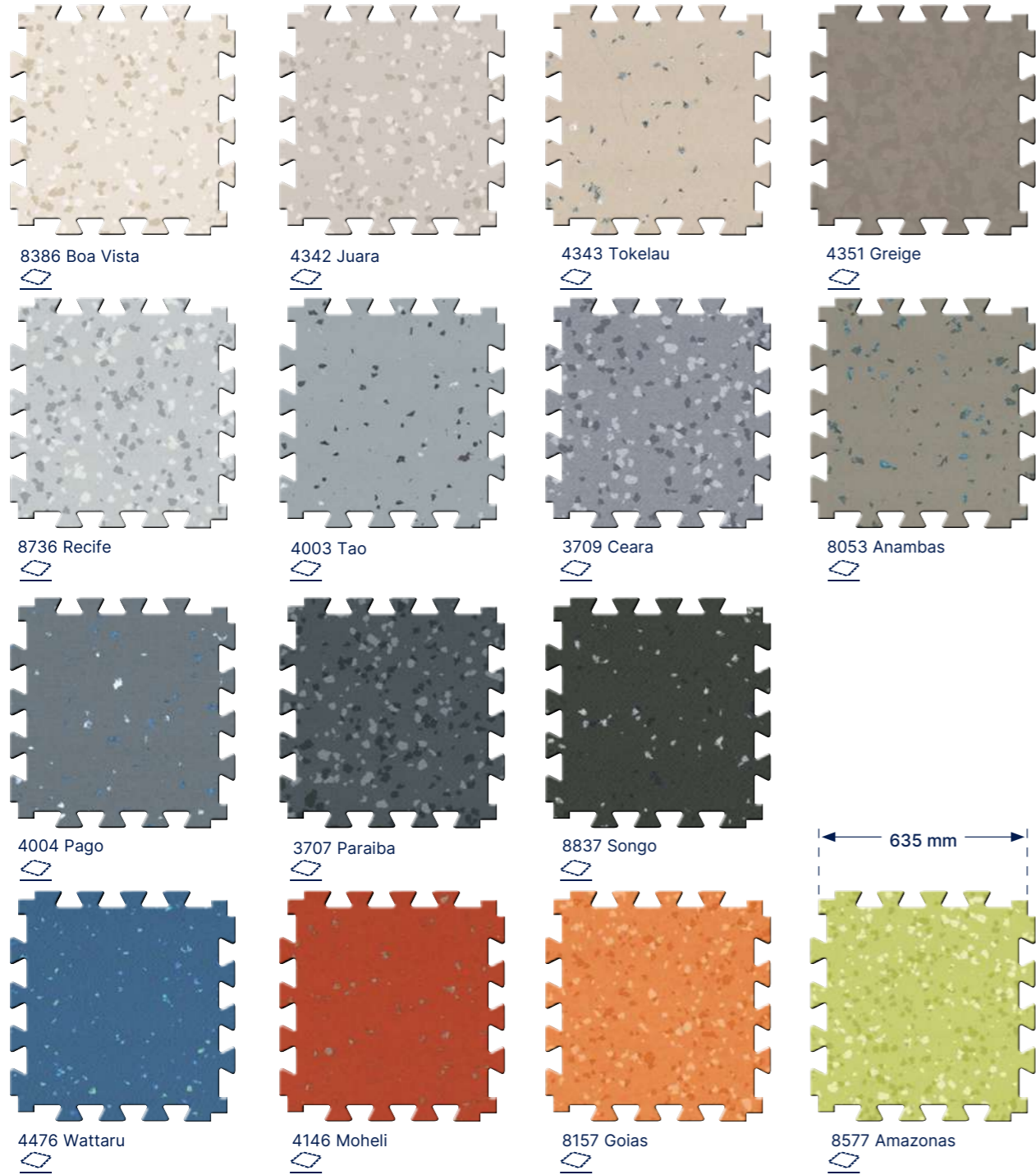

15 interlocking edges per side

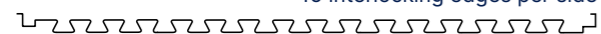

All these colours are available in ATTRACTION® CLEANTECH. For more details please contact your Gerflor representative.

Attraction® - Neopolis



Removable R10 Protecso!® 2

100% recyclable

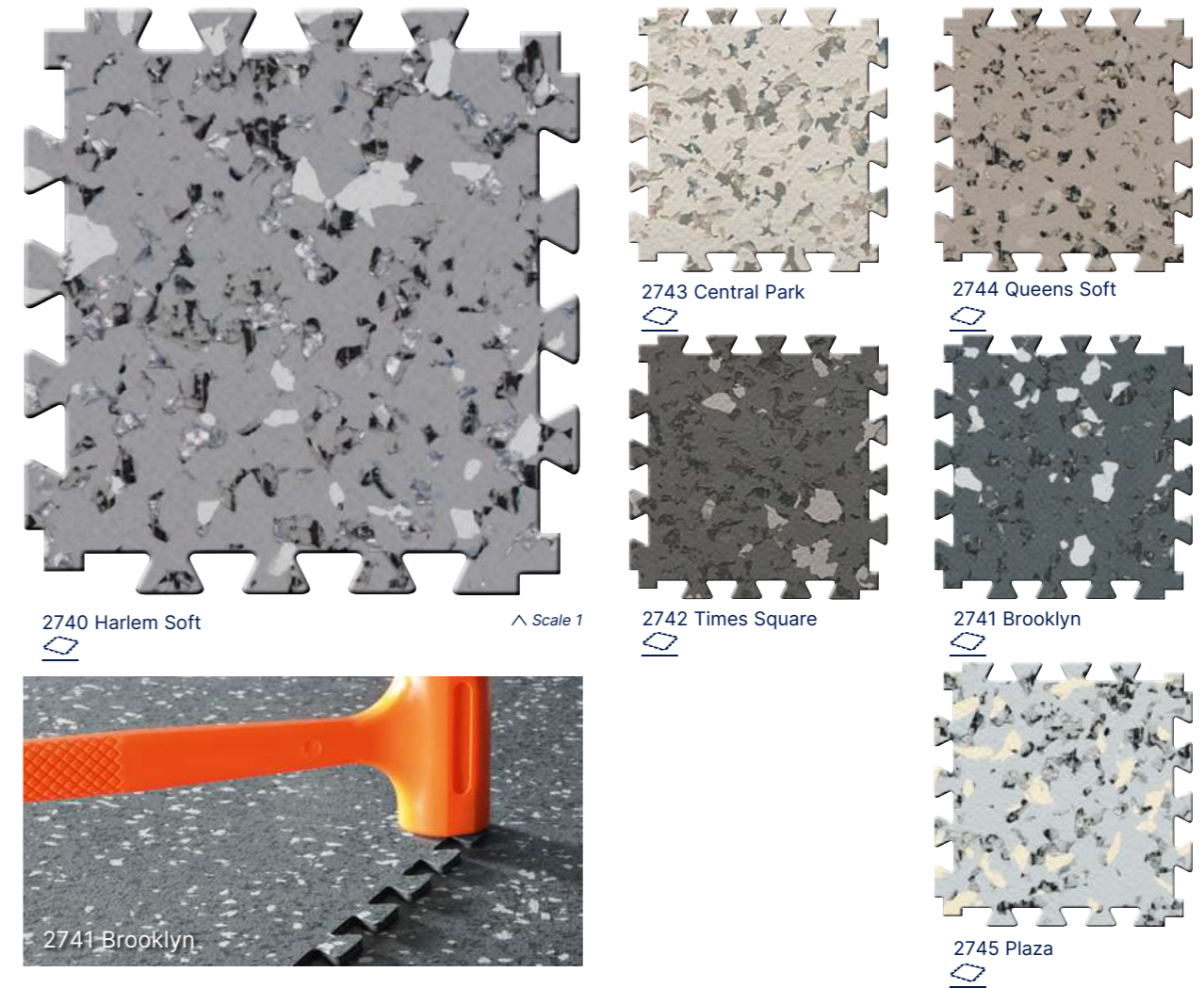

Accessories Attraction®

Aluminium ramp srewed - 5-6 mm



0505

1513

Entrance Mat for Attraction®



Romat GT - Réf. 1719

Esplanade 9000 - Réf. 1700

Corner & Access

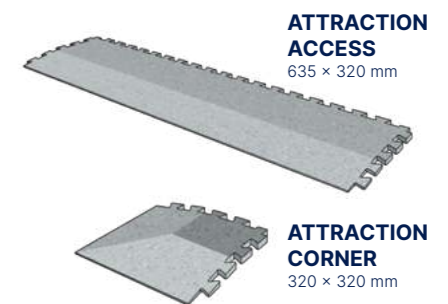

ATTRACTION ACCESS
635 x 320 mm

ATTRACTION CORNER
320 x 320 mm

See page 346

For more information, please refer to our Attraction® brochure.

Fast Track - High Traffic Tiles

Design Tile - R-Tile

Design Tile



Design Tile is a synthetic, decorative, flexible, antistatic, abrasion group T floor covering. It consists in a multi-layered tile with a 0,70 mm thick transparent wear layer and a printed film on an injected molded backing. The overall thickness is 7,8 mm.

Design Tile is an interlocking hidden dovetail loose lay tiles with grout edges. The resistance to use (commercial / industrial use) of 34 / 43 according to EN-ISO 10874 and has Bfl -s1 class for smoke emission according to EN 13501-1.

Design Tile is made from ultra-stable 100% recyclable material with up to 80% of recycled content. It is REACH compliant. The product emission rate of organic compounds is < 100 micrograms/m³ (TVOC <28 days - ISO 16000-6).

R-Tile

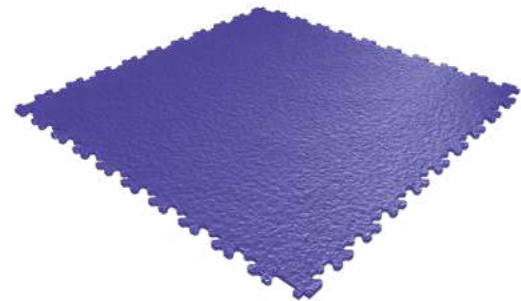

R-Tile is a synthetic, flexible, antistatic, floor covering. It consists in an injected molded backing. The overall thickness is 5, 7 or 9 mm.

R-Tile is an interlocking dovetail loose lay tile. The resistance to use (commercial / industrial use) of 34 / 43 according to EN-ISO 10874 and has Bfl -s1 class for smoke emission according to EN 13501-1.

R-Tile is made from ultra-stable 100% recyclable material with up to 80% of recycled content. It is REACH compliant. The product emission rate of organic compounds is < 100 micrograms/m³ (TVOC <28 days - ISO 16000-6).

Do not forget the finishes & tools

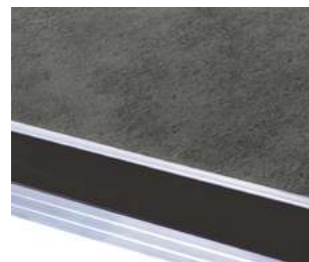

Aluminum Ramp
Screwed - 2,5m
Code: 0663 with Insert (Black, Light Grey, Dark Grey) Code: 4096



Diminishing profile - 2m
Code: 0490



Entrance mat
Esplanade 9000
Code: 1700



Anti Bounce Mallet
Code: 5951

PVC Ramp
2m - Code: 7032



Design Tile:

- Ceramic tile look
- Adhesive free
- Rolling traffic compliant*
- Renovation over ceramic
- Circularity: 100% re-usable or re-cyclable

* Conditions specified in installation guidelines

R-Tile:

Performance

- Withstand Mechanical traffic
- 10 colors available in 5 mm, 7 mm, 9 mm

Easy Installation

- Adhesive Free Interlocking system: Easy to remove and reuse
- Minimal subfloor preparation: easy to install

Safety & Well being

- R10 Slip resistance
- Walking comfort

	Design Tile		R-Tile			
Description						
Total thickness	EN ISO 24346	mm	7.8	5	7	9
Wearlayer thickness	EN ISO 24340	mm	0.70	-	-	-
Weight	EN ISO 23997	g/m ²	12 000	7000	9200	12800
Size	EN ISO 24342	mm	457 × 457 / 614 × 614	503 × 503		
Classification						
Norm / Product specification	-	-	EN ISO 10582	EN ISO 10581		
European classification	EN ISO 10874	class	34-43	34-43		
Fire rating	EN 13501-1	class	Bfl-s1	Bfl-s1		
Static electrical propensity	EN 1815	kV	< 2	< 2		
Slip resistance wet: ramp test with oil	EN 16165:2021 - Appendix B (DIN 51130)	class	R10	R10		
Performances						
Wear resistance	EN 660.2	mm ³	≤ 2.0	-		
Wear group	-	group	T	-		
Type Binder content	EN ISO 10582	type	I	I		
Curling	EN ISO 23999	mm	≤ 1	-		
Dimensional stability	EN ISO 23999	%	≤ 0.15	≤ 0.15		
Residual indentation	EN ISO 24343-1	mm	≤ 0.05	≤ 0.10		
Castor chair test (type W)	ISO 4918	-	OK	OK		
Flexibility	ISO 24344 METHOD A	-	-	No cracking		
Shore Hardness	EN ISO 868	H _d	> 60	≥ 40		
Thermal conductivity	EN ISO 10456	W/(m.k)	0.25	0.25		
Colour fastness	EN ISO 105-B02	degree	≥ 6	≥ 6		
Surface treatment	-	-	PUR+	-		
Chemical products resistance	EN ISO 26987	-	OK	OK		
Environment						
Recyclability	-	%	100	100		
Health						
TVOC after 28 days	ISO 16000-6	microgram/m ³	< 100	< 100		
CE marking						
CE		EN 14041				
Conditions of use						
Rolling traffic	Frequency	-	-	Occasional (1x per day max.)		
	Type of wheeled traffic	-	-	Manual pallet truck	Electric pallet truck and forklift	
	Max total load	kg	-	600	1500	3000
	Max contact pressure	kg/cm ²	-	40	60	80

Fast Track - High Traffic Tiles

Design Tile

Removable R10 PUR+ 100% recyclable

614 × 614 mm format



1696 Acero Light



1696 Acero Light
Light grey grout



1695 Manhattan Cloud
Light grey grout

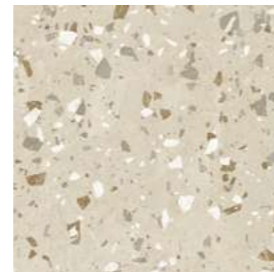

1698 Marmetta Beige
Brown grout



1694 Manhattan Dust
Light grey grout

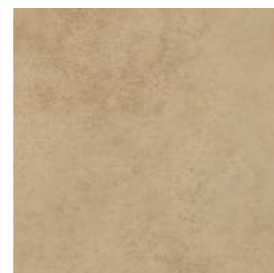

1697 Acero Beige
Light grey grout



1693 Manhattan Grey
Dark grey grout



1699 Luberon Grey
Light grey grout



1692 Manhattan Storm
Dark grey grout

Removable R10 PUR+ 100% recyclable

457 × 457 mm format



1551 Vintage Sand

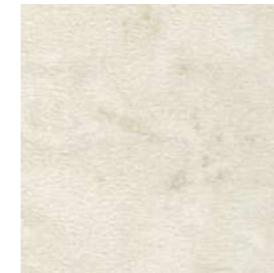

1548 Limestone
Light grey grout



1555 Sandstone
Light grey grout



1545 Clay
Dark grey grout



1546 Granite
Dark grey grout

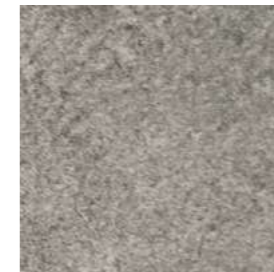

1544 Shalestone
Dark grey grout

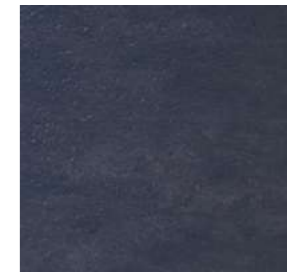

1547 Volcano
Black grout



1553 Terrazzo Cream
Dark grey grout



1554 Terrazzo Grey
Dark grey grout



1549 Polished Concrete
Light grey grout



1550 Vintage Maple
Light grey grout



1552 Vintage Ash
Light grey grout



1551 Vintage Sand
Brown grout

Fast Track - High Traffic Tiles

R-Tile

Removable R10 100% recyclable
503 x 503 mm



7045 Light Grey / 5005 Blue



7045 Light Grey

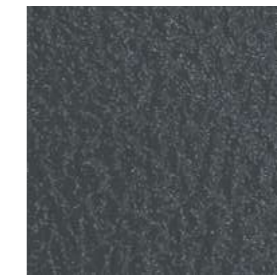

7015 Dark Grey

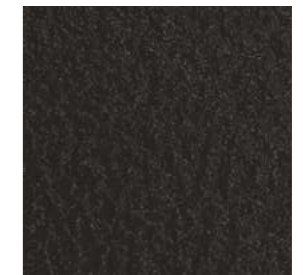

9004 Black



1018 Yellow



5005 Blue



6005 Green



3020 Red

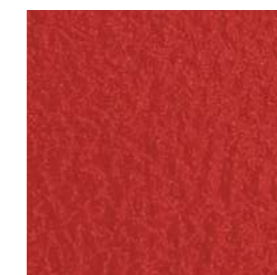

3016 Maroon

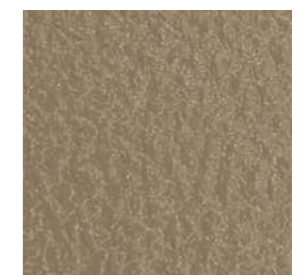

1002 Beige

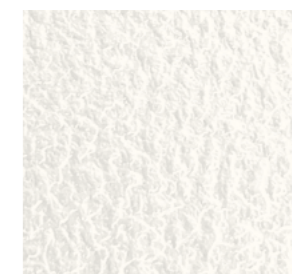

9003 White

Fast Track
High Traffic
Tiles



Technical Solutions

pages 234-253

238. EL5 / EL7 Solutions Dissipative & conductive floors

- 240. Dissipative floors
- 240. Mipolam EL7
- 240. Mipolam Robust EL7

- 241. Conductive floors
- 241. Mipolam EL5
- 241. Mipolam Technic EL5
GTI® EL5 (See page 220)

242. Safety Floorings

- 244. Tarasafe Ultra Sparclean®
- 246. Tarasafe Standard - Plus - Super
- 247. Tarasafe H₂O
Tarasafe Ultra H₂O (See page 250)

248. Shower System

- 250. Tarasafe Ultra H₂O
- 251. Tarasafe Design
- 252. Mural Calypso

Technical solutions

EL5 / EL7
Solutions

Dissipative Floors

EN 1081 (Ω): $10^6 \leq Rt \leq 10^8$

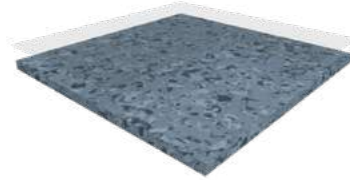

Mipolam EL7



Mipolam Robust EL7

Conductive Floors

EN 1081 (Ω): $10^4 \leq Rt \leq 10^6$



Mipolam EL5

EN 1081 (Ω): $10^4 \leq Rt \leq 10^6$

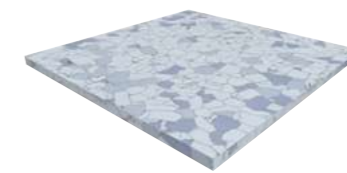

Mipolam Technic EL5

EN 1081 (Ω): $5 \times 10^4 \leq Rt \leq 10^6$

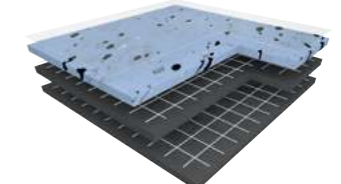

GT1 EL5

Slip Resistant
Floorings

SparClean® Treatment

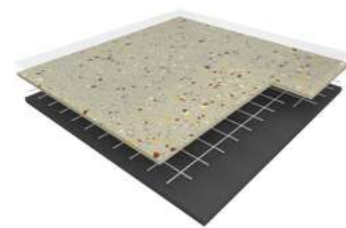

Tarasafe Ultra

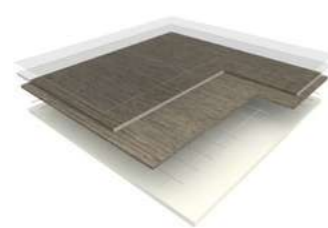

Tarasafe Design

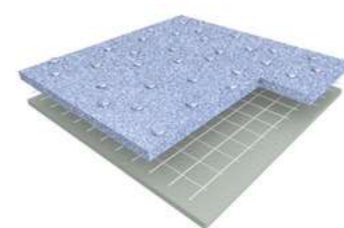

Tarasafe H₂O

SparClean® Treatment

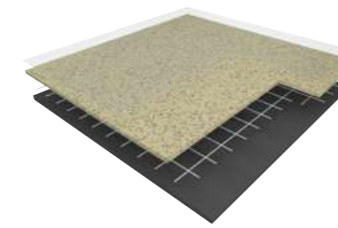

Tarasafe Standard

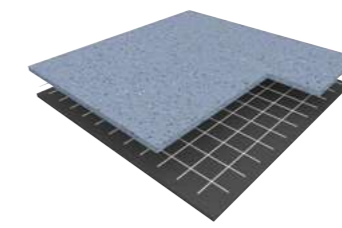

Tarasafe Super

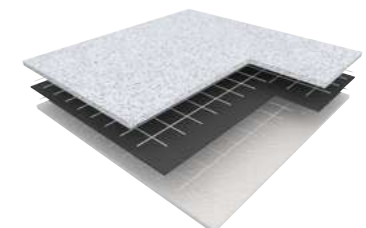

Tarasafe Plus

Shower
System

Floorcoverings

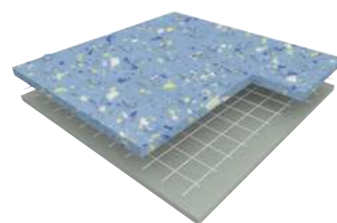

Tarasafe Ultra H₂O

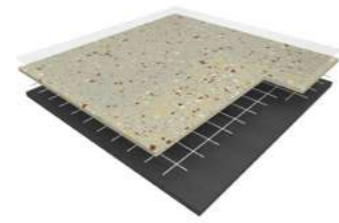

Tarasafe
Standard / Ultra / Design

Wallcoverings

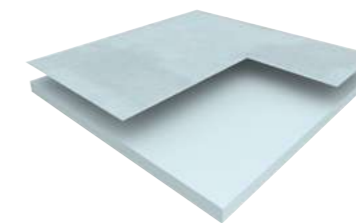

Mural Calypso

Technical
Solutions

Technical solutions

EL5 / EL7 Solutions

Dissipative floors

Mipolam EL7 - Mipolam Robust EL7

Mipolam EL7

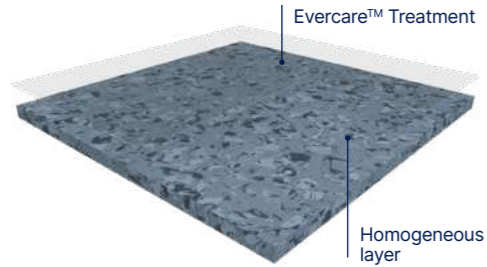

$10^6 \leq Rt \leq 10^8 \Omega$

MIPOLAM EL7 is a dissipative flexible homogeneous vinyl floorcovering available in both sheet and tile form, calendered and compacted and comes in 10 colours. This floorcovering is treated with **EVERCARE™**: the latest improvements in polyurethane surface treatment obtained by UV laser cross-linking. Evercare™ avoids stain of chemical products used in healthcare like Betadine, eosin or anti-bacterial hand gel and increases the durability of the flooring. According to ISO 21702, **MIPOLAM EL7** has **anti-viral activity** against Human Coronaviruses: it reduces the number of virus by 99.7% after 2h. According to ISO 22196, **MIPOLAM EL7** has **anti-bacterial activity** against E. coli, S. aureus and MRSA of 99% after 24h. This treatment has excellent maintenance characteristics; it requires no wax for life! **MIPOLAM EL7** acts as a continuous dissipater $10^6 \leq Rt \leq 10^8$. The product has to be grounded with an ESD copper strip (see finishes) to meet its full performance. The product is non-reactive to residual indentation with a value ≤ 0.02 mm. The flooring has a binder content type II, is suitable for heavy duty traffic areas and has a Bfl-s1 fire resistance. The product is non-emissive of volatile organic compounds with < 10 microgram/m³ (TVOC after 28 days ISO 16000-6).

Mipolam Robust EL7



$10^6 \leq Rt \leq 10^8 \Omega$

MIPOLAM ROBUST EL7 is a dissipative flexible homogeneous vinyl floorcovering available in both sheet and tile. Calendered and compacted. It acts as a continuous dissipater $10^6 \leq Rt \leq 10^8$ (EN 1081).

Conductive floors

Mipolam EL5 - Mipolam Technic EL5

Mipolam EL5

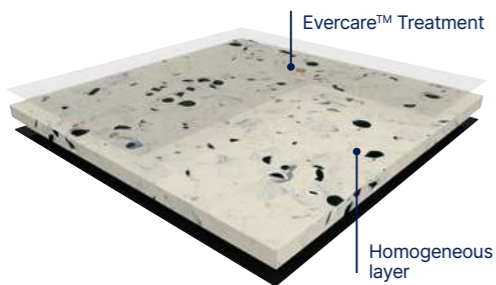

$10^4 \leq Rt \leq 10^8 \Omega$

MIPOLAM EL5 is a conductive flexible homogeneous vinyl floorcovering available in sheet. The 2 mm homogeneous material incorporates carbon encapsulated granules throughout its full thickness. It has a **conductive backing** to ensure optimal and consistent conductive properties throughout its full life expectancy. This floorcovering is treated with **EVERCARE™**: the latest improvements in polyurethane surface treatment obtained by UV laser cross-linking. Evercare™ avoids stain of chemical products used in healthcare like Betadine, eosin or anti-bacterial hand gel and increases the durability of the flooring. According to ISO 21702, **MIPOLAM EL5** has **anti-viral activity** against Human Coronaviruses: it reduces the number of virus by 99.7% after 2h. According to ISO 22196, **MIPOLAM EL5** has **anti-bacterial activity** against E. coli, S. aureus and MRSA of 99% after 24h. This treatment has excellent maintenance characteristics; it requires no wax for life! **MIPOLAM EL5** acts as a continuous conductive $10^4 \leq Rt \leq 10^8$. The product has to be grounded with an ESD copper strip (see finishes) to meet its full performance. The product is non-reactive to residual indentation with a value ≤ 0.02 mm (EN ISO 24343-1). The flooring complies with the EN ISO 10874 (34-43) offering a binder content type II, is suitable for heavy duty traffic areas and has a Bfl-s1 fire resistance. The product is non-emissive of volatile organic compounds with < 10 microgram/m³ (TVOC after 28 days ISO 16000-6).

Mipolam Technic EL5

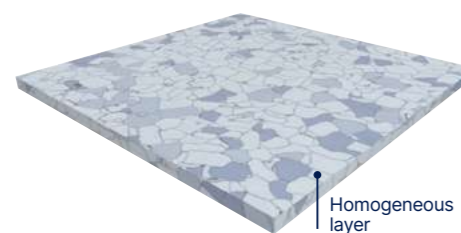

$10^4 \leq Rt \leq 10^8 \Omega$

MIPOLAM TECHNIC EL5 is a conductive flexible homogeneous compacted vinyl floorcovering available in tiles. The conductive carbon coated PVC pellets create a perfect conductive network for permanent conductive and antistatic properties throughout its full life expectancy. It acts as a continuous conductive $10^4 \leq Rt \leq 10^8$ (EN 1081).

A complete range for Hi-tech applications: electronics and telecommunication areas, computer rooms, operating theatres, radiology...

- Compacted floorcovering for better hygiene, maintenance, and traffic resistance.
- Available in tiles and sheets with specific formats especially adapted to raised floors (608 × 608 mm).

			Mipolam EL7	Mipolam Robust EL7	Mipolam EL5	Mipolam Technic EL5
Description						
Total thickness	EN ISO 24346	mm	2	2	2	2
Weight	EN ISO 23997	g/sqm	3100	3300	2985	3800
Width of sheet	EN ISO 24341	cm	200	200	200	-
Length of sheet	EN ISO 24341	lm	20	20	20	-
Tile size	EN ISO 24342	mm	608 × 608	608 × 608	-	608 × 608
Number of tiles per package	-	-	20	20	-	20
Phthalate free	-	-	OK	OK	OK	OK

Classification						
Norm / Product specification	-	-	EN ISO 10581	EN ISO 10581	EN ISO 10581	EN ISO 10581
European classification	EN ISO 10874	class	34-43	34-43	34-43	34-43
Fire rating	EN 13501-1	class	Bfl-s1	Bfl-s1	Bfl-s1	Bfl-s1
Electrical resistance ⁽¹⁾	EN 1081	Ohm	$10^6 \leq Rt \leq 10^8$	$10^6 \leq Rt \leq 10^8$	$10^4 \leq Rt \leq 10^6$	$10^4 \leq Rt \leq 10^6$
Static electrical propensity	EN 1815	kV	< 2	< 2	< 2	< 2
Slip resistance wet	EN 16165:2021 – Appendix B (DIN 51 130)	class	R9	-	R9	-

Performances						
Type Binder content	EN ISO 10581	type	II	II	I	II
Dimensional stability	EN ISO 23999	%	Sheet ≤ 0.40 Tile ≤ 0.25	Sheet ≤ 0.40 Tile ≤ 0.25	≤ 0.40	≈ 0.25
Residual indentation (norm)	EN ISO 24343-1		≤ 0.10	≤ 0.10	≤ 0.10	≤ 0.10
Residual indentation (average measured value)	EN ISO 24343-1	mm	≈ 0.02	≈ 0.03	≈ 0.02	≈ 0.03
Castor chair test (type W)	ISO 4918	-	OK	OK	OK	OK
Thermal conductivity	EN ISO 10456	W/(m.k)	0.25	0.25	0.25	0.25
Colour fastness	EN ISO 105-B02	degree	≥ 6	≥ 6	≥ 6	≥ 6
Surface treatment	-	-	Evercare™	-	Evercare™	-
Chemical products resistance ⁽²⁾	EN ISO 26987	-	OK	OK	OK	OK

Health						
TVOC after 28 days	ISO 16000-6	microgram/m ³	< 10	< 10	< 10	< 10
Certification	-	-	Floorscore®	-	Floorscore®	-
Anti-bacterial activity (E.coli – S. aureus – MRSA) after 24h ⁽³⁾	ISO 22196	-	$> 99\%$ inhibits growth	-	$> 99\%$ inhibits growth	-
Anti-viral activity (human coronavirus) after 2h ⁽³⁾	ISO 21702	-	$> 99.7\%$ virucidal activity	-	$> 99.7\%$ virucidal activity	-

CE marking						
CE	EN 14041					

(1) Measured before installation.

(2) Staining table available upon request.

(3) The implementation of an effective cleaning method is the best defence against infection

Important: please refer to Gerflor installation guidelines - www.gerflor.com

Technical solutions

Dissipative floors: Mipolam EL7 & Mipolam Robust EL7



Mipolam EL7



 $10^6 \leq Rt \leq 10^8 \Omega$ Evercare™  100% recyclable



Mipolam Robust EL7

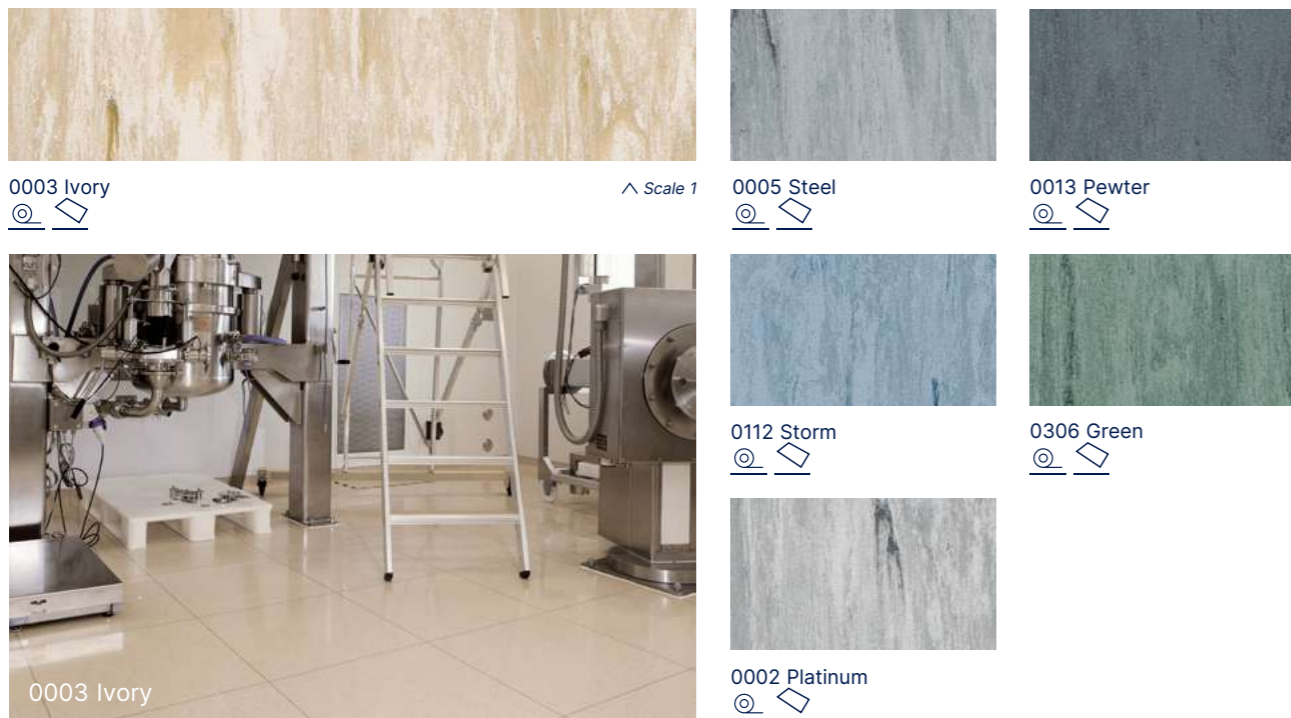

 $10^6 \leq Rt \leq 10^8 \Omega$  100% recyclable



Conductive floors: Mipolam EL5 / Technic EL5 / GTI EL5

Mipolam EL5

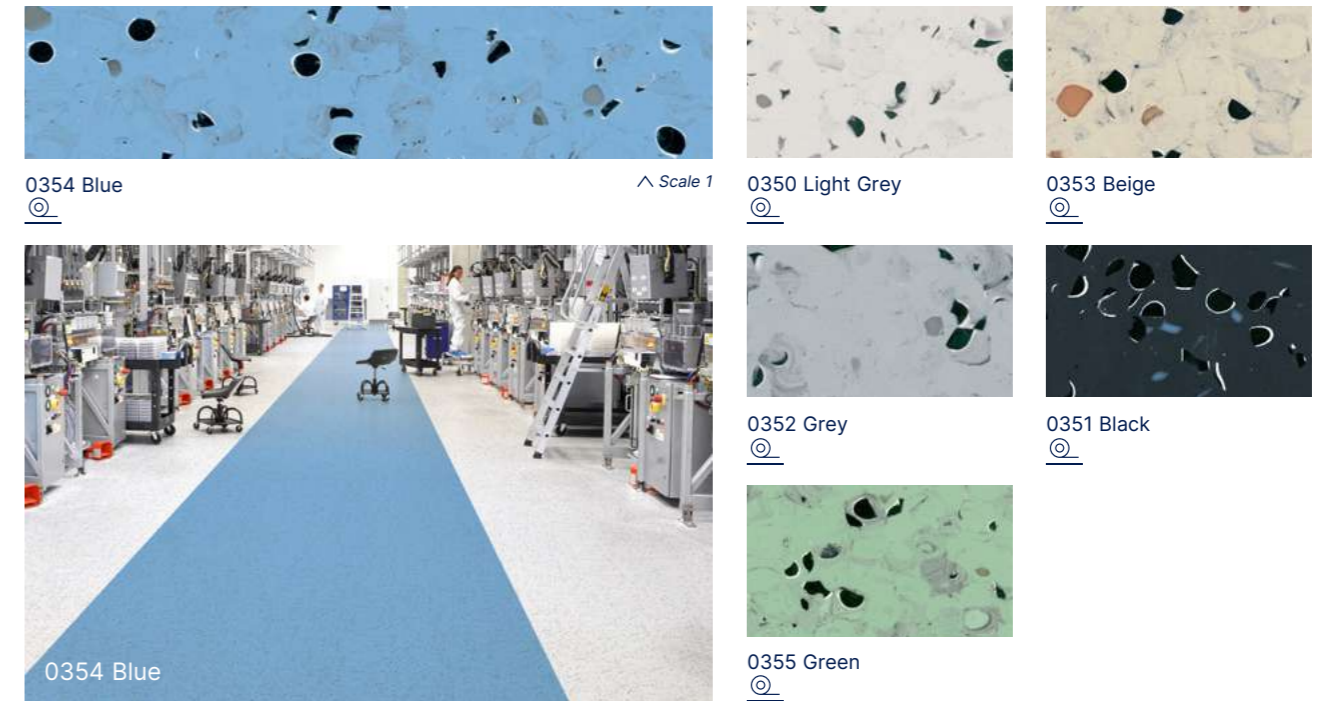
 $10^4 \leq Rt \leq 10^8 \Omega$ Evercare™  100% recyclable



Mipolam Technic EL5

 $10^4 \leq Rt \leq 10^8 \Omega$  100% recyclable



GTI® EL5

GTI® EL5 (See page 220)



Removable R9 Evercare™  100% recyclable

Technical solutions

Safety Floorings - Tarasafe

Tarasafe Ultra: Sparclean® Treated

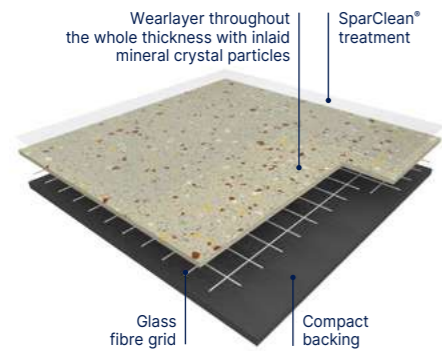

TARASAFE ULTRA is a hardwearing safety flooring collection that comprises of a PVC wear layer and deeply inlaid mineral crystal particles (patented) and coloured chips for a decorative design. It is suitable for heavy traffic areas and is ideal for hardworking contract applications. It delivers Safety in Numbers, with a PTV >36+ slip resistance (Dry & Wet), a R10 wet slip resistance rating and >20 Rtm/Rz surface roughness in accordance with HSE guidelines. The revolutionary **SparClean®** surface treatment improves the product performance in terms of stain resistance and durability. It contains 29% recycled content.

Tarasafe Standard: Sparclean® Treated

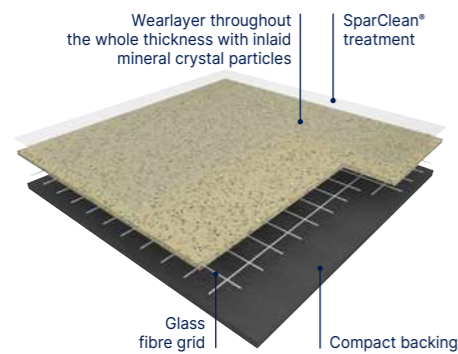

TARASAFE STANDARD is a hardwearing safety flooring collection that comprises of a PVC wear layer and deeply inlaid mineral crystal particles (patented). It is suitable for heavy traffic areas and is ideal for hardworking contract applications. It delivers Safety in Numbers, with a PTV >36+ slip resistance (Dry & Wet), a R10 wet slip resistance rating and >20 Rtm/Rz surface roughness in accordance with HSE guidelines. The revolutionary **SparClean®** surface treatment improves the product performance in terms of stain resistance and durability. It contains 29% recycled content.

Tarasafe Plus / Tarasafe Super: Non-Treated

Tarasafe Super

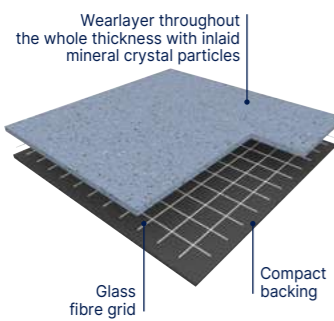

Tarasafe Plus

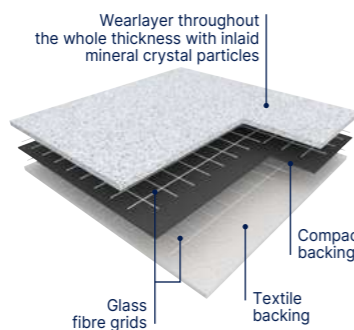

TARASAFE PLUS and **TARASAFE SUPER** are slip resistant safety vinyl floorcoverings, wearlayer throughout the whole thickness and deeply inlaid mineral crystal particles (patented). They are reinforced by a glass fibre grid and available in a sheet format. They are an ideal solution for heavy traffic applications where slip resistance, durability, hygiene and easy maintenance are required. **TARASAFE PLUS** comprises a textile backing for better adherence in wet areas. It helps reducing telegraphing. **TARASAFE SUPER** and **PLUS** are suitable for most contract & commercial areas. They are 100% recyclable, Floorscore® certified and do not contain any heavy metals or CMR 1&2, they are also 100% compliant with REACH. The product emission rate of volatile organic compounds is < 100 microgram/m³ (TVOC after 28 days – ISO 16000 -6).

Tarasafe Ultra H₂O

See page 250

Tarasafe H₂O

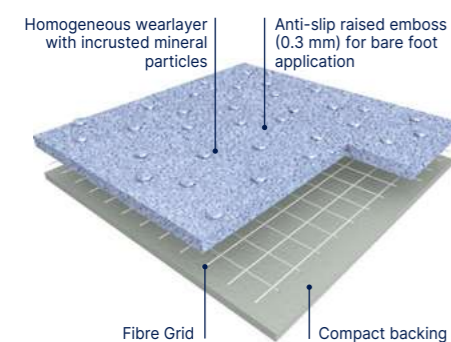

TARASAFE H₂O is a hardwearing safety flooring collection that comprises of a PVC wear layer containing deeply inlaid mineral particles and coloured elements for a subtle and soft design. It is an ideal solution for those areas where enhanced slip resistance is required for both barefoot and shod use, such as showers, wet rooms, bathrooms, & changing areas. The specific embossing, together with the mineral particles, delivers a Class B barefoot slip resistance rating (according to EN 16165:2021-A and AS 4586-C) and R11 shod slip resistance rating (according to EN 16165: 2021-B and AS 4586-D). It delivers Safety in Numbers, with a PTV >50 slip resistance (Dry & Wet), a R11 wet slip resistance rating and >20 Rtm/Rz surface roughness in accordance with HSE guidelines. The revolutionary **SparClean®** surface treatment improves the product performance in terms of stain resistance and durability. It is reinforced with a glass fibre grid in sheet form for improved durability and is 100% recyclable. It contains 29% recycled content.

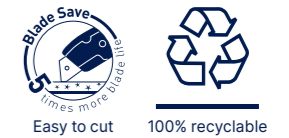

- **Easy to clean and maintain:** due to a compacted non porous surface made of vinyl content
- **Permanent slip resistance:** dense concentration of deep inlaid mineral crystal particles throughout the wear layer
- **Enhanced colour, design and brightness:** due to the mineral crystal particles
- **Highest abrasion rating**
- **Indoor Air Quality:** low VOC emission

Description	Tarasafe						
	Ultra	Standard	Super	Plus	H ₂ O		
Description							
Total thickness	EN ISO 24346	mm	2.0	2.0	2.2	2.5	2.00
Thickness of wearlayer	EN ISO 24340	mm	0.85	0.85	1.12	1.14	0.85
Weight	EN ISO 23997	g/sqm	2360	2360	2880	3090	2350
Width/Length of sheet	EN ISO 24341	cm/ml	200/20	200/20	200/20	200/20	200/20
Classification							
Norm/Product specification	-	-	EN ISO 10582		EN ISO 10582		EN ISO 10582
European classification	EN ISO 10874	class	34-43	34-43	34-43		34-43
Fire rating	EN 13501-1	class	Bfl-s1	Bfl-s1	Bfl-s1		Bfl-s1
Static electrical propensity	EN 1815	kV	≤ 2	≤ 2	< 2		≤ 2
Slip resistance: Pendulum Test (dry & wet)	EN 16165:2021 – Appendix C (BS 7976-2)	PTV	> 36	> 36	-		> 50
Surface roughness Rz	-	µm	Rz ≥ 20	Rz ≥ 20	-		Rz ≥ 20
Slip resistance wet: Ramp test with oil	EN 16165:2021 – Appendix B (DIN 51130)	class	R10	R10	R12	R10	R11
Slip resistance wet: Ramp test with water	EN 16165:2021 – Appendix A (DIN 51097)	class	B	B	-		B
Slip resistance: Ramp test	EN 13845 (annex C)	class	ESf / ESb	ESf / ESb	-		ESf / ESb
Water tightness	EN 13553	-	-	-	-		OK
Slip resistance wet - areas	CTE	class	-	-	-		3
Performances							
Wear resistance	EN 660.2	mm ³	≤2	≤2	≤2		-
Wear Group	-	group	T	T	-		-
Type Binder content	EN ISO 10582	type	I	I	I		I
Dimensional stability	EN ISO 23999	%	≤ 0.40	≤ 0.40	≤ 0.40		≤ 0.40
Residual indentation: exigency	EN ISO 24343-1	mm	≤ 0.10	≤ 0.10	≤ 0.10		≤ 0.10
Residual indentation (average measure)	-	mm	≤ 0.03	≤ 0.05	≈ 0.03		-
Castor chair test (type W)	ISO 4918	-	OK	OK	OK		OK
Thermal conductivity	EN ISO 10456	W/(m.K)	0.25	0.25	0.25		0.25
Colour fastness	EN ISO 105-B02	degree	≥ 6	≥ 6	≥ 6		≥ 6
Surface treatment	-	-	SparClean®	SparClean®	-		SparClean®
Chemical products resistance	EN ISO 26987	-	OK	OK	OK		OK
Environment							
Recyclability	-	%	100	100	100		100
EPD	-	-	Available	Available	Available		Available
Health							
TVOC after 28 days	ISO 16000-6	microgram/m ³	< 100	< 100	< 100		< 100
Certification	-	-	Floorscore®	Floorscore®	Floorscore®		Floorscore®
Anti-bacterial activity (MRSA) ⁽¹⁾	ISO 22196	-	> 99% inhibits growth	> 99% inhibits growth	-		> 99% ⁽²⁾ inhibits growth
CE marking							
CE	EN 14041						

(1) The implementation of an effective cleaning regime is the most important defence against infection.

Technical solutions

Tarasafe Ultra Sparclean®

Compact 2 m R10 SparClean®



8701 Opal

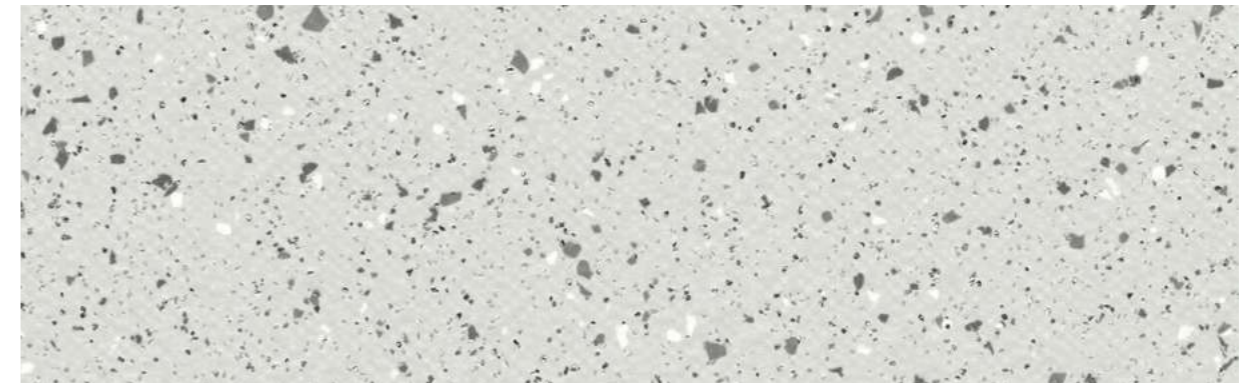

8701 Opal

^ Scale 1



7724 Calcium

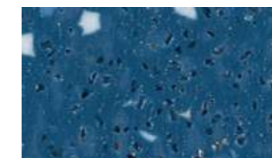

9127 Meteorite

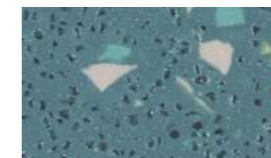

6593 Epidote

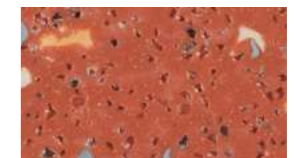

7307 Copper

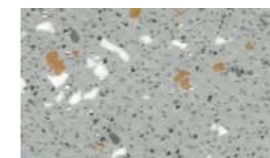

8704 Pebble

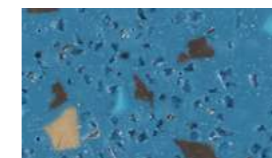

8420 Azurite



8592 Aventurine



3183 Bauxite

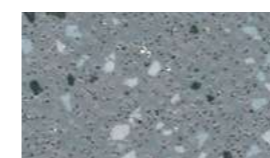

8709 Granite

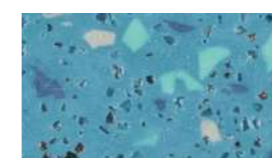

2432 Larimar

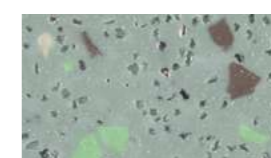

6591 Serpentine



6088 Andalusite

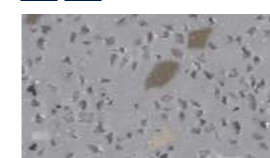

7792 Galena

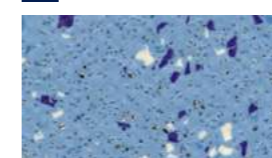

7482 Halite



7383 Diopside



6348 Clay

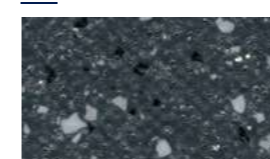

8717 Obsidian



Color reference available as Tarasafe Ultra H₂O (R11).

Technical solutions

Tarasafe Standard - Plus - Super

Tarasafe Standard
 Compact 2 m R10 SparClean®

Tarasafe Plus
 Compact 2.5mm 2 m R10
 Textile Backing

Tarasafe Super
 Compact 2 m R12



7801 Noir
 Compact

^ Scale 1



7731 Marbre⁽¹⁾
 Compact



7618 Edelweiss
 Compact



7767 Dove Grey^{(1) (2)}
 Compact



7386 Savana^{(1) (2)}
 Compact



7773 Storm
 Compact

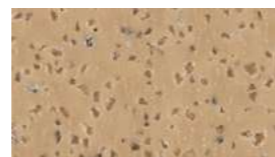

7315 Jute
 Compact

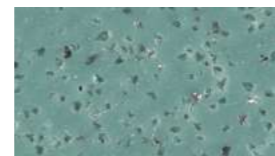

6589 Leaf
 Compact



6084 Badian
 Compact



6245 Atoll
 Compact



8102 Paprika
 Compact



2430 Rain Drop
 Compact

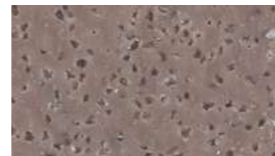

6085 Grizzly
 Compact



7709 Royal Blue
 Compact

(1) Tarasafe Plus - (2) Tarasafe Super



7801 Noir

Tarasafe H2O



0036 Lagoa

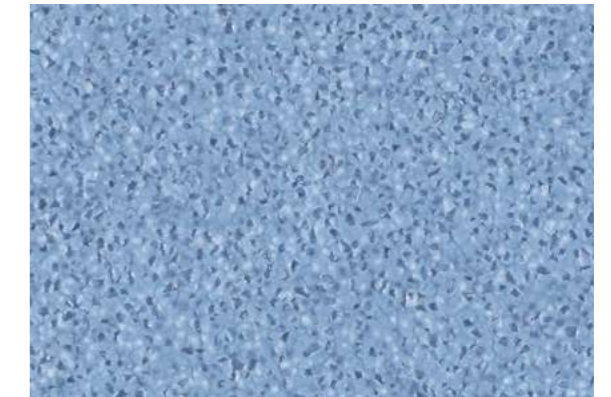

0036 Lagoa
 Compact

^ Scale 1



0034 Zambezi
 Compact



0033 Rhine
 Compact

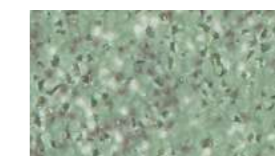

0035 Bacalar
 Compact



0024 Peyto
 Compact

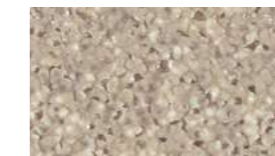

0031 Eacham
 Compact



0032 Malawi
 Compact



0025 Nile
 Compact

Technical solutions

Shower System

Tarasafe Ultra H2O

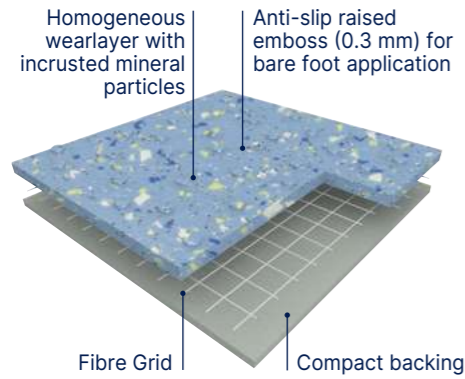

TARASAFE ULTRA H2O is a slip resistant vinyl floorcovering, wearlayer throughout the whole thickness and deeply inlaid mineral particles and coloured chips for a decorative design together with a raised emboss for better slip resistance. **TARASAFE ULTRA H2O** is an ideal solution for traffic applications where enhanced slip resistance with barefoot and durability are required such as wet areas. The specific embossing together with the mineral particles give a Class C barefoot slip resistance (DIN 51 097) and R11 slip resistance (DIN 51 130) which makes **TARASAFE ULTRA H2O** ideal for barefoot or shod applications. It is reinforced with a glass fibre grid in sheet form. Its homogeneous wear layer provides a group P of abrasion. According to ISO 22196, **TARASAFE ULTRA H2O** has **anti-bacterial activity** against MRSA of 99% after 24h. It does not contain any heavy metals or CMR 1&2 and it is 100% compliant with REACH. The product emission rate of volatile organic compounds is < 100 microgram/m³ (TVOC after 28 days – ISO 16000 -6). This product is 100% recyclable and contains 39% recycled content.

Tarasafe Design

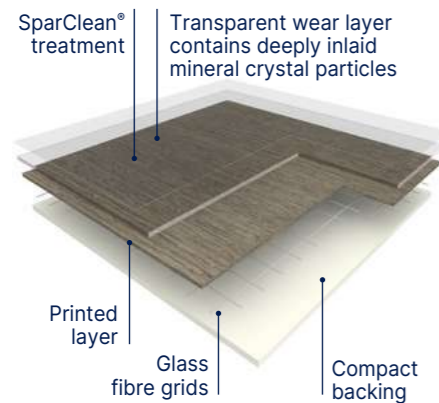

TARASAFE COMPACT DESIGN is a slip resistant vinyl floorcovering in sheet, which transparent wear layer contains deeply inlaid mineral crystal particles for durable shod (R10 according to DIN 51130) and barefoot (B according to DIN 51097) antislip performances. It is available in 6 realistic wood or mineral designs thanks to a printed layer. It is reinforced with a glass fibre grid and treated with SparClean® surface treatment, a low maintenance cost effective solution providing extreme resistance from soiling and staining. According to ISO 22196, it has an **anti-bacterial activity** against MRSA of 99% after 24 hours. It is an ideal solution for applications where enhanced slip resistance, durability, hygiene and easy maintenance are required – such as for instance showers, changing rooms, sanitation facilities, laboratories... It does not contain any heavy metals or CMR 1&2 and are 100% compliant with REACH. The product emission rate of volatile organic compounds is < 100 microgram/m³ (TVOC after 28 days – ISO 16000-6). It is 100% recyclable.

Mural Calypso

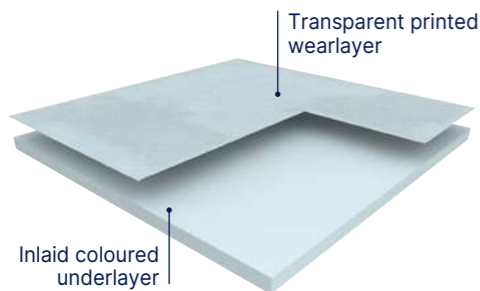

MURAL CALYPSO is a multilayered wall covering in 2 m width roll and with a **B-s2,d0 fire classification** according to EN 13501. It is hot welded with CR40 welding rods for a perfect water tightness. It is made of a printed transparent wear layer and a coloured under layer for a better aspect of the welding. This layer comprises up to 30% of recycled products. According to ISO 22196, **MURAL CALYPSO** has **anti-bacterial activity** against E. coli, S. aureus and MRSA of 99% after 24h. It does not contain any CMR 1 & 2 component and is 100% compliant with REACH. It is 100% recyclable. This wall covering is specially recommended for wet room areas and makes the installation in angles easier thanks to its flexibility. The Shower System is compliant with most laws on "access for all" thanks to the installation in shower without tray.

Gerflor also recommends the Tarasafe compact ranges with surface treatments (SparClean®: Ultra, Standard & Design) for the use in wet room areas. See pages 244-246 & 251

Floor & wall accessories for wet rooms (profiles, drains & threshold) on gerflor.com

Tarasafe Ultra H2O / Tarasafe Design / Mural Calypso



The SHOWER SYSTEM provides a safe and hygienic solution thanks to:

- Anti-slip resistance floorings
- 100% waterproof installation

			Tarasafe Ultra H ₂ O	Tarasafe Design	Mural Calypso
Description					
Total thickness	EN ISO 24346	mm	2.0 (on grainside)	2.0	0.92
Thickness of wearlayer	EN ISO 24340	mm	1.0	0.80	0.10
Weight	EN ISO 23997	g/sqm	2400	2500	1610
Width/Length of sheet	EN ISO 24341	cm/ml	200/20	200/20	200/30
Classification					
Product specification	-	-	EN ISO 10582	EN ISO 10582	EN 259-1
European classification	EN ISO 10874	class	34-43	34-43	-
Fire rating	EN 13501-1	class	Cfl-s1	Bfl-s1	B-s2,d0
Static electrical propensity	EN 1815	kV	≤ 2	< 2	-
Slip resistance - Pendulum Test (dry & wet)	EN 16165:2021 – Appendix C (BS 7976-2)	PTV	> 36	> 36	-
Surface roughness	-	µm	Rz ≥ 20	-	-
Slip resistance wet - test with oil	EN 16165:2021 – Appendix B (DIN 51 130)	class	R11	R10	-
Slip resistance wet - bare foot	EN 16165:2021 – Appendix A (DIN 51097)	class	C	B	-
Slip resistance - ramp test	EN 13845 (annex C)	class	ESb	ESf / ESb	-
Water tightness	EN 13553	-	OK	OK	-
Slip resistance wet - areas	CTE	class	3	-	-
Performances					
Wear Resistance	EN 660.2	mm ³	≤ 4	-	-
Wear Group	NF 189	group	P	-	-
Type Binder content	ISO 10582	type	I	I	-
Dimensional stability	EN ISO 23999	%	≤ 0.40	≤ 0.40	-
Residual indentation	EN ISO 24343-1	mm	≤ 0.10	≤ 0.10	-
Residual indentation (measure)	-	mm	≤ 0.03	≤ 0.03	-
Castor Chair test (type W)	ISO 4918	-	OK	-	-
Thermal conductivity	EN ISO 10456	W/(m.k)	0.25	0.25	-
Colour fastness	EN ISO 105-B02	degree	≥ 6	≥ 6	≥ 6
Surface treatment	-	-	-	SparClean®	-
Chemical products resistance	EN ISO 26987	-	OK	OK	OK
Environment					
Recyclability	-	%	100	100	100
EPD	-	-	Available	Available	Available
Health					
TVOC after 28 days	ISO 16000-6	microgram/m ³	< 100	< 100	< 100
Certification	-	-	Floorscore®	Floorscore®	-
Anti-bacterial activity ⁽¹⁾ (E. coli - S. aureus - MRSA)	ISO 22196	-	> 99% ⁽²⁾ inhibits growth	> 99% ⁽²⁾ inhibits growth	> 99% ⁽³⁾ inhibits growth
CE marking					
	EN 15102	-	-	-	OK
CE	EN 14041		-	-	-
			-	-	-

(1) The implementation of an effective cleaning regime is the most important defence against infection.
 (2) Anti-bacterial activity (MRSA)
 (3) Anti-bacterial activity (E. coli - S. aureus - MRSA)

Technical solutions

Antislip Floorings - Tarasafe Ultra H2O



7720 Iceberg



7720 Iceberg ^ Scale 1

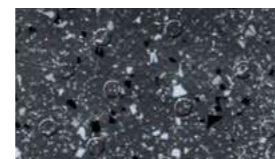

7732 Gravel

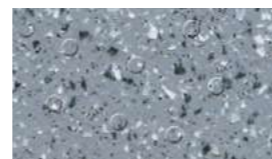

7746 Stone

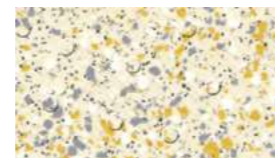

7325 Seashore

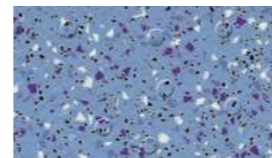

7413 Ocean Blue



Antislip Floorings - Tarasafe Design



6171 Lofter Dark Grey



6079 Esterel Nut New ^ Scale 1



6078 Esterel Clear New



6083 Esterel Blossom New

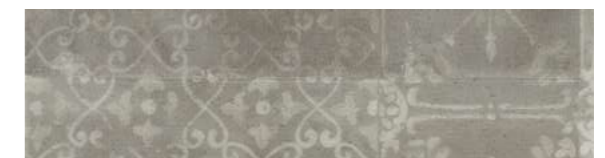

5755 Lorca Natural New



6171 Lofter Dark Grey



6094 Infinity Sand



Technical solutions

Mural Calypso

 Compact
  Bs2d0
  100% recyclable

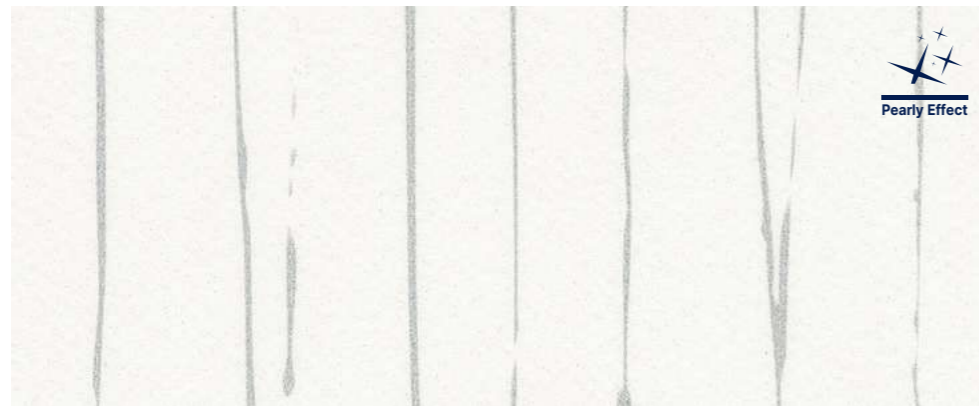

7000 Bamboo Snow Pearl*

^ Décor échelle 1



Mural Calypso: Venice
 Tarasafe Standard: Dove Grey



7002 Bamboo Lotus**

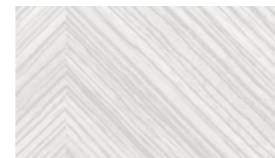

7026 Arty Grey





7025 Arty Beige



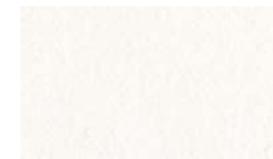

7744 Nordic Milk

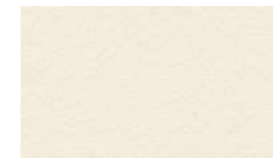
7611 Uni Snow



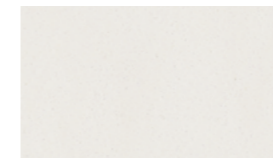

7021 Uni Lotus





7020 Uni Ice



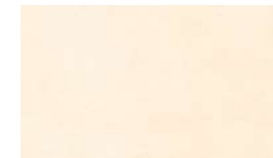

7711 Cloud Ice



7309 Cloud Lotus



7017 Cloud Pink





7014 Ginko Snow Green*



7013 Ginko Snow Gold*



7022 Envol Snow Green*





7023 Envol Snow Skyline*





7016 Tropic Terra Copper





7015 Tropic Skyline

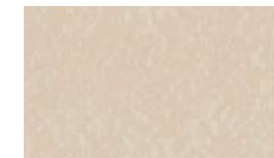

7018 Cloud Green

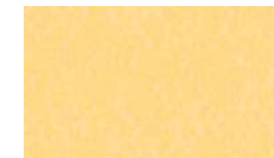

7311 Cloud Linen





7201 Cloud Moonlight



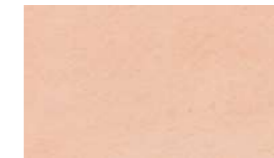

7408 Cloud Skyline

7019 Cloud Terra



7024 Venice



7027 Verona





7740 Fabric Silk



7721 Manhattan Mist

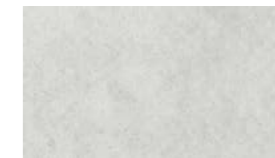

7005 Blossom Snow Pearl*

7010 Cloud Haze

*Matching design: 7611 Uni Snow
 **Matching design: 7021 Uni Lotus

More information on accessories (drains, threshold...) on gerflor.com.

Creative by Nature

DLW Linoleum

pages 254-283

264. Compact / Acoustic Linoleum

- 266. Marmorette
- 272. Colorette
- 274. Uni Walton
- 276. Lino Art Urban **New**
- 278. Lino Art Moon **New**

280. Technic Linoleum

- 281. Linodur -
High Mechanical Traffic Resistance
- 281. Marmorette LCH -
Dissipative Linoleum for ESD areas

DLW Linoleum

Creative by Nature



98%
natural

83%
Rapidly renewable

38% Linseed oil	26% Wood flour	14% Limestone
7% Jute	7% Resin	1% Coloured pigments
1% Cork	4% Coffee chaff	

To fight climate emergency and natural resources depletion, every choice counts. DLW Linoleum is a 98% natural, low carbon and circular flooring solution.

we care / we act

Sustainable by Nature

Cradle to Cradle Certified™ SILVER⁽¹⁾

Developed using circular economy principles

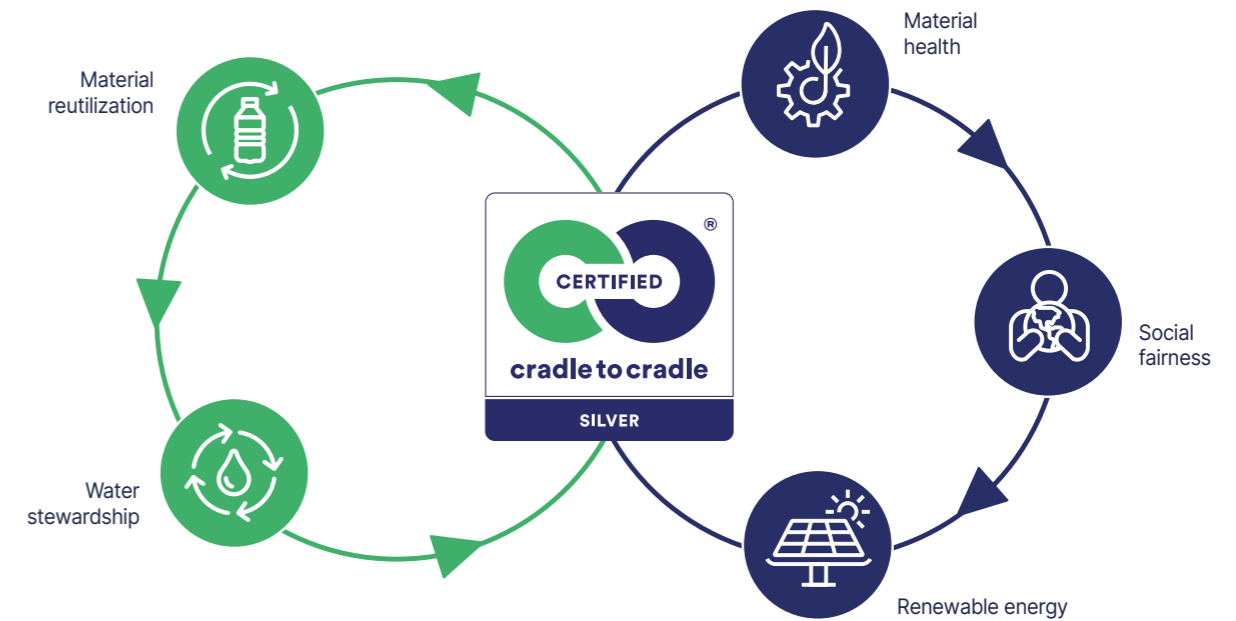

Cradle Certified™ is a registered trademark of the Cradle to Cradle Products Innovation Institute.

Carbon neutral⁽²⁾



Third party certified EPD indicates carbon neutrality during the first stages of its life cycle.

Up to **40%**

Recycled content

100 % recyclable



All Gerflor floorings are 100% recyclable and eligible to **Gerflor Second Life collection and recycling program**. Free collection of installation waste is available in 10 countries.

(1) Marmorette, Colorette, Uni Walton, Linodur, Marmorette Acoustic 15dB, Lino Art. / Cradle Certified™ is a registered trademark of the Cradle to Cradle Products Innovation Institute.
 (2) Cradle to Gate: From Cradle to Gate: includes raw materials and manufacturing process (A1-A3 stages of EPD). Source: Environmental Product Declaration (EPD). Certified by Evea. More information on gerflor.com

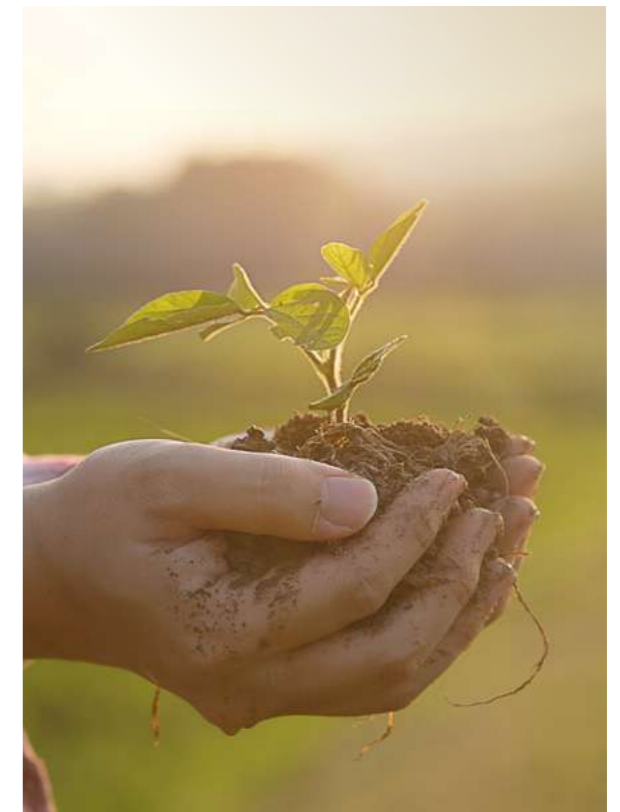

DLW Linoleum

Protective by Nature



Solvent-free surface protection, developed exclusively for linoleum

Extremely hard-wearing due to triple laser uv cross-linking technology



Indoor Air Quality



- Very low VOC emissions TVOC < 10 microgram/m³ after 28 days (ISO 16516)
- Certified according to the most demanding standards



Natural Design



Matt Effect



Marmorette 0056 Foggy Blue

Exclusive



Easy To Clean



Standard Linoleum

- Dirt and stain barrier
- Cost effective maintenance
- Easy cleaning with a mop or any modern cleaning equipment



Neocare™

Detailed cleaning protocol available on www.gerfor.com



Hygiene

DLW Linoleum floorings contribute to lower the microbe load (bacteria, virus, ...) and to minimise the risk of a contamination chain.

- Excellent resistance against disinfection chemicals
- Anti-viral and anti-bacterial activity



Durable

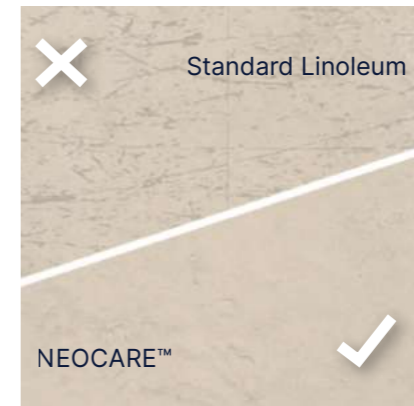

Standard Linoleum

NEOCARE™



- No sealing and waxing needed
- Higher scratch resistance
- Easy to repair: in case of heavily damaged flooring, DLW linoleum can be easily repaired using the spray buffing method (red disk)

Waxing



Neocare™ is a high performing surface treatment protecting against dirt, stains and scratches and does not require any sealing & waxing throughout the life of the product. Waxing remains an option.



DLW Linoleum

Mix & Match

Uni Walton
0100 Ocean Blue

Marmorette
0148 Ink Blue

Lino Art Urban
0586 Light Clay

Marmorette
0023 Dusty Blue

Colorette
0052 Oxid Grey

Marmorette
0098 Desert Beige

Uni Walton
0062 Mediterranean Orange





Lino Art Moon
0233 Venus

Colorette
0073 Sand Yellow

Marmorette
0117 Mandarin Orange



Visualize your project
Interior Designer

			Marmorette		Colorette / Uni Walton		Lino Art Urban / Moon	Marmorette Acoustic	Marmorette Acoustic Plus Colorette Acoustic Plus Uni Walton Acoustic Plus	Linodur	Marmorette LCH
Description			R10		Bfl-s1						
Total thickness	EN ISO 24346	mm	2.0 / 2.5 / 3.2	2.5	2.5	2.5	2.5	4.0	4.0	4.0	2.5
Backing	-	-	Jute fabric		Jute fabric		Jute fabric	Cork and jute fabric backing	Foam backing	Jute fabric	Jute fabric
Thickness of cork/foam backing	EN ISO 24340	-	-		-		-	2	1.5	-	-
Weight	EN ISO 23997	g/sqm	2400 / 2900 / 3800	2900	2900	2900	2900	3900	3500	4700	3000
Width of sheet	EN ISO 24341	cm	200		200		200	200	200*	200	200
Length of sheet	EN ISO 24341	m	20-31		20-31		20-31	20-31	20-31*	app. 28	20 - 31
Classification											
Norm/Product specification	-	-	EN ISO 24011		EN ISO 24011		EN ISO 24011	EN 687	EN 686	EN ISO 24011	EN ISO 24011
European classification	EN ISO 10874	class	23 / 34 / 43		23 / 34 / 43		23 / 34 / 43	23 / 33 / 41	23 / 33 / 41	23 / 34 / 43	23 / 34 / 43
Classement UPEC	-	-	- / U4P3E1/2C2		-		U4P3E1/2C2	-	-	-	-
Fire rating**	EN 13501-1	class	Cfl-s1		Bfl-s1		Cfl-s1	Cfl-s1	Cfl-s1	Cfl-s1	Cfl-s1
Slip resistance	EN 16165:2021 – Appendix B (DIN 51130)	class	R9	R10	R9	R9	R9	R9	R9	R10	R9
Impact sound insulation	EN ISO 717-2	dB	3 dB / 5 dB / 6 dB	5 dB	5 dB	5 dB	5 dB	15 dB	19 dB	8 dB	5 dB
Performances											
Residual indentation	EN ISO 24343-1	mm	≤ 0,15	≤ 0,15	≤ 0,15	≤ 0,15	≤ 0,15	≤ 0,40	≤ 0,30	≤ 0,20	≤ 0,15
Residual indentation mesurage value	EN ISO 24343-1	mm	≈ 0,08 / ≈ 0,09 / ≈ 0,10	≈ 0,09	≈ 0,09	≈ 0,09	≈ 0,09	≈ 0,20	≈ 0,16	≈ 0,15	≈ 0,09
Colour fastness	EN ISO 105-B02	rating	≥ 6		≥ 6		≥ 6	≥ 6	≥ 6	≥ 6	≥ 6
Vertical resistance	EN 1081	Ohm	-		-		-	-	-	-	10 ⁶ ≤ R ≤ 10 ⁸
Point contact resistance	VDE 0100	kOhm	> 200		> 200		> 200	> 200	> 200	> 200	> 100
Static electrical propensity	EN 1815	kV	≤ 2		≤ 2		≤ 2	≤ 2	≤ 2	≤ 2	≤ 2
Castor chair test (Type W)	ISO 4918	-	OK		OK		OK	OK	OK	OK	OK
Flexibility	ISO 24344	mm	Ø 40 (2.5 mm)		Ø 40		Ø 40	Ø 60	Ø 40	Ø 60	Ø 40
Flexibility / average measured value	ISO 24344	mm	≈ Ø 30 (2.5 mm)		≈ Ø 30		≈ Ø 30	≈ Ø 30	Ø 35	≈ Ø 50	≈ Ø 30
Thermal resistance	EN 12667	(m ² /K)/W	0.012 / 0.015 / 0.018	0.015	0.015	0.015	0.015	0.04	0.044	0.023	0.015
Thermal conductivity	EN ISO 10456	W/(m.K)	0.17		0.17		0.17	0.17	0.0937	0.17	0.17
Surface treatment	-	-	Neocare™		Neocare™		Neocare™	Neocare™	Neocare™	Neocare™	Neocare™
Chemical products resistance	EN ISO 26987	-	Excellent		Excellent		Excellent	Excellent	Excellent	Excellent	Excellent
Environment											
Recycled content (average)	-	%	Up to 40	Up to 40	Up to 40	Up to 40	Up to 40	Up to 40	98	Up to 40	Up to 40
Recyclability	-	%	100		100		100	100	100	100	100
EPD	-	-	Available		Available		Available	Available	In progress	Available	Available
Health											
TVOC after 28 days	EN 16516	microgram/m ³	< 10		< 10		< 10	< 10	< 10	< 50	< 10
Anti-bacterial activity (E. coli – S. aureus – MRSA) after 24 h***	EN ISO 22196 / JIS Z 2801	-	> 99.99 % inhibits growth		> 99.99 % inhibits growth		> 99.99 % inhibits growth	> 99.99 % inhibits growth	> 99.99 % inhibits growth	> 99.99 % inhibits growth	> 99.99 % inhibits growth
Anti-viral activity (Human coronavirus) after 5 h***	ISO 21702	-	> 98.65 % virucidal activity		> 98.65 % virucidal activity		> 98.65 % virucidal activity	> 98.65 % virucidal activity	> 98.65 % virucidal activity	> 98.65 % virucidal activity	> 98.65 % virucidal activity
Circular economy											
Certification	Cradle to Cradle	-	Silver	-	Silver	Silver	Silver	Silver	Bronze	Silver	-
CE marking											
	EN 14041: 2004 AC: 2006	-									

* Roll dimension 1.96m x 18-291m for single roll production.

** Glued according to certificate. DOP numbers available from your local branch.

*** The implementation of an effective cleaning method is the best defence against infection.

 Depending on light exposure, the product color can vary, due to linoleum natural oxidization process. This process is reversible. We recommend that the samples be exposed to sunlight for several hours prior to making a final color choice.

Compact Linoleum

Marmorette / Colorette / Uni Walton / Lino Art

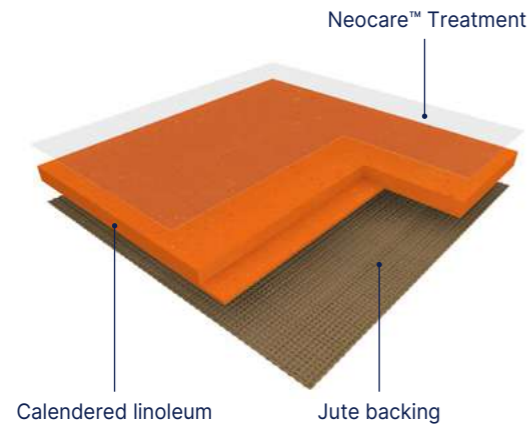

MARMORETTE is a calendered linoleum compact floorcovering in sheet, 2m wide, providing excellent resistance to everyday wear and tear in high traffic areas. Its weight is 2400g/sqm in 2.0mm, 2900g/sqm in 2.5mm and 3800g/sqm in 3.2mm. It features a marbled design and presents a matt finish, is composed of 98% natural materials (linseed oil, wood flour, resin, minerals, coffee chaff and jute fabric) among of which 83% are rapidly renewable.

COLORETTE is a calendered linoleum compact floorcovering in sheet, 2m wide, providing excellent resistance to everyday wear and tear in high traffic areas. Its weight is 2900g/sqm in 2.5mm. It features a speckled design and presents a matt finish, is composed of 98% natural materials (linseed oil, wood flour, resin, minerals, coffee chaff and jute fabric) among of which 83% are rapidly renewable.

UNI WALTON is a calendered linoleum compact floorcovering in sheet, 2m wide, providing excellent resistance to everyday wear and tear in high traffic areas. Its weight is 2900g/sqm in 2.5mm. It features a uni design and presents a matt finish, is composed of 98% natural materials (linseed oil, wood flour, resin, minerals, coffee chaff and jute fabric) among of which 83% are rapidly renewable.

LINO ART is a calendered linoleum compact floorcovering in sheet, 2m wide, providing excellent resistance to everyday wear and tear in high traffic areas. Its weight is 2900g/sqm in 2.5mm. It features a modern urban & terrazzo design (moon) and presents a matt finish, is composed of 98% natural materials (linseed oil, wood flour, resin, minerals, coffee chaff and jute fabric) among of which 83% are rapidly renewable.

COLORETTE, MARMORETTE, UNI WALTON, LINO ART
The floorings are produced with Neocare™ solvent-free surface treatment, an exclusive photo-cured acrylate based lacquer surface treatment obtained by triple laser UV cross linking. Neocare™ offers excellent scratch resistance as well as resistance to chemicals found in aggressive environments such as bleach, hydro alcoholic solutions, Betadine and Eosin as well as markers making maintenance easier and increasing the life of the flooring. This treatment avoids performing any polishing throughout the lifetime of the product. It can however be polished following usual recommendations and according to the customer's wishes.

The products ensure perfect indoor air quality (TVOC at 28 days (EN 16516) < 10 microgram/m³) and are classified A + (the best class) in the context of health labeling. It is Floorscore®, M1 and Blue Angel certified. The floorings are 100% recyclable, are composed of up to 40% recycled content, 100% controlled, are REACH compliant and rated Cfl-s1 for fire resistance. Designed and manufactured in a sustainable way in a plant awarded with ISO 9001 (quality), ISO 14001 (environment) and ISO 50001 (energy) certifications, the floorings are Cradle to Cradle certified™ Silver. They are Environmental Performance Declaration (EPD) certified by an external laboratory indicating carbon neutrality during the first stages of their life cycle ("from cradle to gate"). The Camouflage (Marmorette) or Uni (Colorette, Uni Walton, Lino Art) welding rod makes the connections between the strips invisible. They are antistatic, antibacterial according to ISO 22196 / JIS Z 2801 and antiviral according to ISO 21702.

Acoustic Linoleum

Marmorette AcousticPlus /
Colorette AcousticPlus /
Uni Walton AcousticPlus

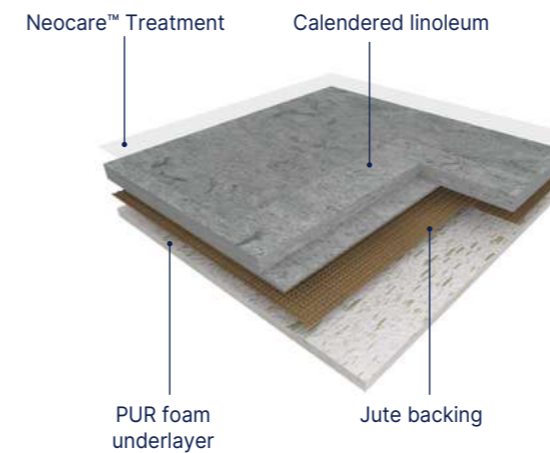

MARMORETTE ACOUSTIC PLUS is a calendered linoleum acoustic floorcovering in sheet, 2m wide, providing excellent resistance to everyday wear and tear in high traffic areas. Its weight is 3500g/sqm in 4.0mm. It features a marbled design and presents a matt finish, is composed of natural materials (linseed oil, wood flour, resins, minerals coffee chaff and jute fabric), rapidly renewable and features a 1.5mm recycled foam underlayer, ensuring up to 19dB impact sound reduction.

COLORETTE ACOUSTIC PLUS is a calendered linoleum acoustic floorcovering in sheet, 2m wide, providing excellent resistance to everyday wear and tear in high traffic areas. Its weight is 3500g/sqm in 4.0mm. It features a speckled design and presents a matt finish, is composed of natural materials (linseed oil, wood flour, resins, minerals coffee chaff and jute fabric), rapidly renewable and features a 1.5mm recycled foam underlayer, ensuring up to 19dB impact sound reduction.

UNI WALTON ACOUSTIC PLUS is a calendered linoleum acoustic floorcovering in sheet, 2m wide, providing excellent resistance to everyday wear and tear in high traffic areas. Its weight is 3500g/sqm in 4.0mm. It features a uni design and presents a matt finish, is composed of natural materials (linseed oil, wood flour, resins, minerals coffee chaff and jute fabric), rapidly renewable and features a 1.5mm recycled foam underlayer, ensuring up to 19dB impact sound reduction.

Marmorette Acoustic

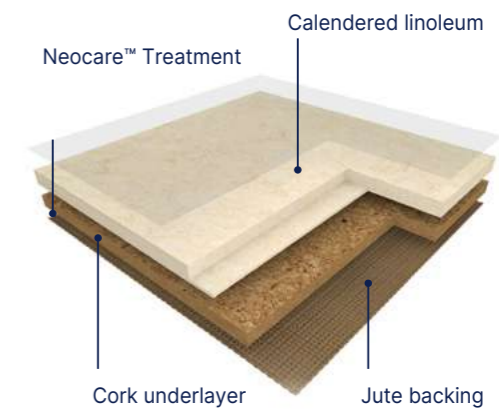

MARMORETTE ACOUSTIC is a calendered linoleum acoustic floorcovering in sheet, 2m wide, providing excellent resistance to everyday wear and tear in high traffic areas. Its weight is 3900g/sqm in 4.0mm. It features a marbled design and presents a matt finish, is composed of natural materials (linseed oil, wood flour, resins, cork, minerals coffee chaff and jute fabric), rapidly renewable and features a 2mm cork underlayer, ensuring up to 15dB impact sound reduction.

MARMORETTE ACOUSTIC PLUS / COLORETTE ACOUSTIC PLUS / UNI WALTON ACOUSTIC PLUS / MARMORETTE ACOUSTIC
The floorings are produced with Neocare™ solvent-free surface treatment, an exclusive photo-cured acrylate based lacquer surface treatment obtained by triple laser UV cross linking. Neocare™ offers excellent scratch resistance as well as resistance to chemicals found in aggressive environments such as bleach, hydro alcoholic solutions, Betadine and Eosin as well as markers making maintenance easier and increasing the life of the flooring. This treatment avoids performing any polishing throughout the lifetime of the product. It can however be polished following usual recommendations and according to the customer's wishes. The products ensure perfect indoor air quality (TVOC at 28 days (EN 16516) < 10 microgram/m³) and are classified A + (the best class) in the context of health labeling. They are Floorscore®, M1 and Blue Angel certified. The floorings are 100% recyclable, are composed of up to 44% recycled content (Acoustic Plus), 100% controlled, are REACH compliant and rated Cfl-s1 for fire resistance. Designed and manufactured in a sustainable way in a plant awarded with ISO 9001 (quality), ISO 14001 (environment) and ISO 50001 (energy) certifications, the floorings are Cradle to Cradle certified™ Bronze (Marmorette Acoustic Plus, Colorette Acoustic Plus) and Cradle to Cradle certified™ Silver (Marmorette Acoustic). Their Environmental Performance Declaration (EPD) certified by an external laboratory, indicate carbon neutrality during the first stages of their life cycle ("from cradle to gate"). The Camouflage (Marmorette) or Uni (Colorette, Uni Walton, Lino Art) welding rod makes the connections between the strips invisible. They are antistatic, antibacterial according to ISO 22196 / JIS Z 2801 and antiviral according to ISO 21702.

Korkment: Cork Acoustic Underlayer



2.0 mm underlayer
(weight 1.2 kg/sqm)
15 dB impact sound
reduction

Ref R1020102

Compact / Acoustic Linoleum

Marmorette



Neocare™

2.0mm

2.5mm

3.2mm



0155 Smoked Pearl
2,5 mm



0056 Foggy Blue
2,5 mm / 3,2 mm

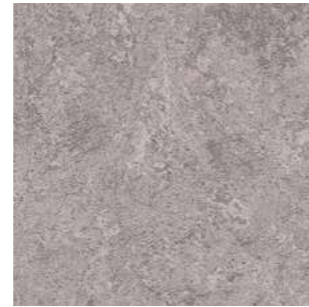

0153 Greystone Grey
2,5 mm



0158 Tabac Grey
2,5 mm



0055 Ash Grey
2,0 mm / 2,5 mm / 3,2 mm



0053 Ice Grey
2,0 mm / 2,5 mm / 3,2 mm



0050 Quartz Grey
2,0 mm / 2,5 mm / 3,2 mm



0059 Plumb Grey
2,0 mm / 2,5 mm / 3,2 mm



0054 Concrete Patty
2,5 mm



0160 Industrial Grey
2,0 mm / 2,5 mm



0096 Midnight Grey
2,5 mm



0108 Mokka Brown
2,5 mm



0254 Mineral Grey
2,5 mm



0166 Clay
2,5 mm



0164 Milk Coffee
2,5 mm



0252 Light Grey
2,5 mm

^ Scale 1



0251 Cream
2,5 mm



0146 Beeswax Beige
2,5 mm



0059 Plumb Grey



0253 Pebble Grey
2,5 mm



0090 Soapstone
2,5 mm



0106 Hazelnut Shake
2,5 mm



0003 Dark Brown
2,5 mm



0091 Shiitake Mushroom
2,5 mm



0089 Peacan Pie
2,5 mm

A Acoustic 15 dB in stock **A+** AcousticPlus 19 dB in stock **R10** R10: in stock **Bfl** Bfl-s1: in stock

All other colours can be manufactured in Acoustic 15dB version. Special request - Minimum order quantity: 1500sqm. Below 1500sqm, use Korkment underlayer.
All other colours can be manufactured in Acoustic Plus 19dB version. Special request - Minimum order quantity: 58sqm.

Compact / Acoustic Linoleum

Marmorette



Neocare™



0072 Golden Yellow
2,5 mm



0172 Papaya Orange
2,5 mm



0076 Pale Yellow
2,5 mm



0098 Desert Beige
2,0 mm / 2,5 mm



0073 Spicy Orange
2,5 mm



0173 Melon Orange
2,5 mm



0243 Marble Beige
2,5 mm



0045 Sand Beige
2,0 mm / 2,5 mm



0117 Mandarin Orange
2,5 mm



0118 Chili Red
2,5 mm



0018 Lobster Red
2,5 mm



0145 Banana White
2,5 mm



0119 Terracotta
2,5 mm



0019 Sunset Orange
2,5 mm



0075 Light Aurora
2,5 mm



0211 Pink
2,5 mm



0070 Rocky Brown
2,0 mm / 2,5 mm / 3,2 mm



^ Scale 1



0042 Shortcrust
2,5 mm



0040 Light Sahara
2,0 mm / 2,5 mm



0092 Beach
2,5 mm



Acoustic 15 dB in stock AcousticPlus 19 dB in stock R10: in stock Bfl-s1: in stock

All other colours can be manufactured in Acoustic 15dB version. Special request - Minimum order quantity: 1500sqm. Below 1500sqm, use Korkment underlayer.
All other colours can be manufactured in Acoustic Plus 19dB version. Special request - Minimum order quantity: 58sqm.

Compact / Acoustic Linoleum

Marmorette



Neocare™



0129 Curacao Petrol
2,5 mm

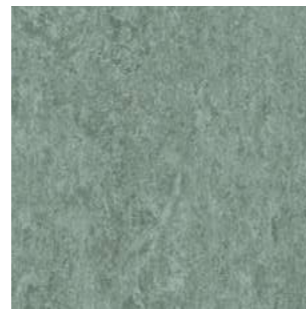

^ Scale 1
0099 Grey Turquoise
2,5 mm

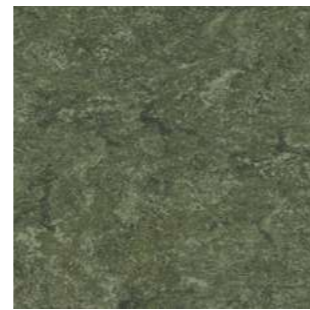

0083 Jungle
2,5 mm



0132 Lime Green

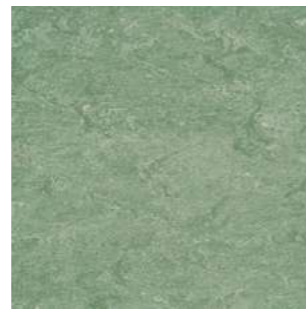

0043 Leaf Green
2,5 mm

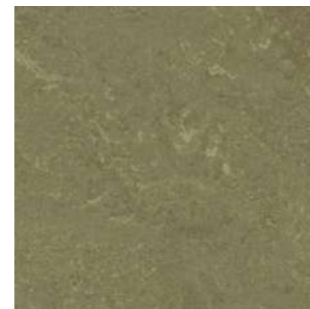

0138 Khaki
2,5 mm

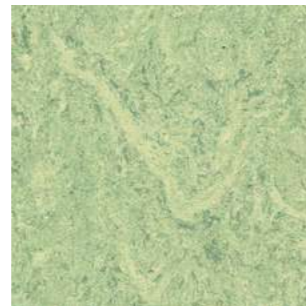

0130 Antique Green
2,5 mm



0100 Frog Green
2,5 mm



0132 Lime Green
2,5 mm



0121 Blue Eyes
2,5 mm



0122 Fluffy Blue
2,5 mm

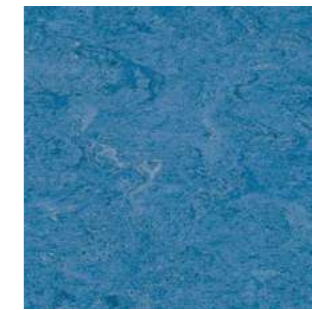

0026 Sky Blue
2,5 mm



0023 Dusty Blue **A** **A+** **R10** **Bfl**
2,0 mm / 2,5 mm /
3,2 mm



0049 Royal Blue
2,5 mm / 3,2 mm



0022 Autumn Blue **A+**
2,5 mm / 3,2 mm



0224 Mystery Blue
2,5 mm



0149 Dark Blue
2,5 mm

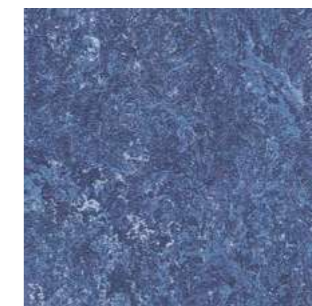

A+ 0148 Ink Blue
2,5 mm

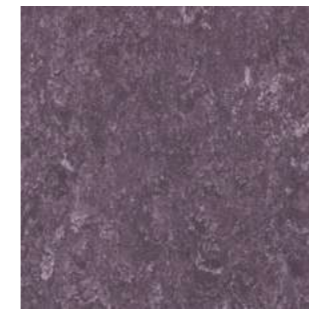

0128 Violet
2,5 mm



0028 Dive
2,5 mm



0136 Turquoise Bay
2,5 mm

A Acoustic 15 dB in stock **A+** AcousticPlus 19 dB in stock **R10** R10: in stock **Bfl** Bfl-s1: in stock

All other colours can be manufactured in Acoustic 15dB version. Special request - Minimum order quantity: 1500sqm. Below 1500sqm, use Korkment underlayer.
All other colours can be manufactured in Acoustic Plus 19dB version. Special request - Minimum order quantity: 58sqm.

Compact / Acoustic Linoleum

Colorette



0001 Banana Yellow
2,5 mm

^ Scale 1



0071 Straw Beige
2,5 mm



0016 Deep Orange
2,5 mm



0132 Spicy Green
2,5 mm



0052 Oxid Grey
2,5 mm

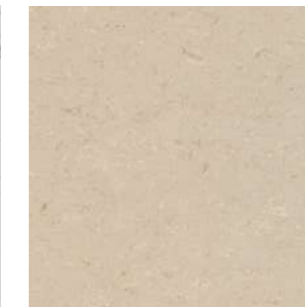

0012 Light Beige
2,5 mm



© Jose Hevia

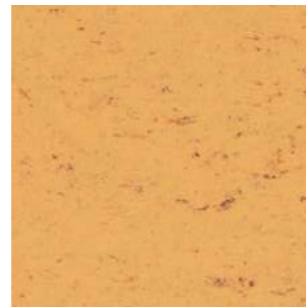

0073 Sand Yellow
2,5 mm



0170 Kumquat Orange
2,5 mm



0171 Sunrise Orange
2,5 mm



0118 Power Red
2,5 mm



0110 Cadillac Pink
2,5 mm

AcousticPlus 19dB in stock



0006 Vivid Green
2,5 mm

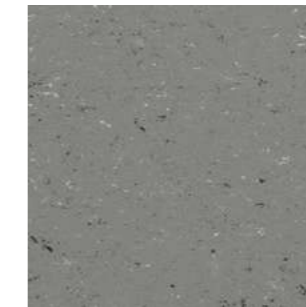

0059 Stone Grey
2,5 mm



0043 Light Mud
2,5 mm

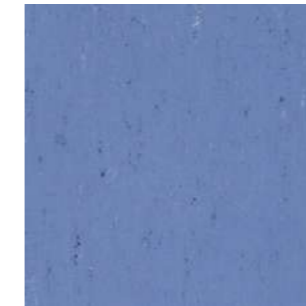

0004 Bluebird
2,5 mm

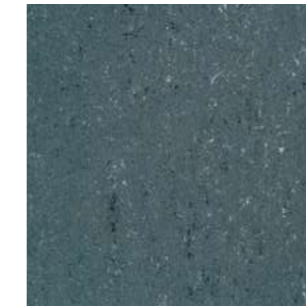

0080 Elephant Grey
2,5 mm



0058 Aluminium Grey
2,5 mm



0123 Poppy Blue
2,5 mm

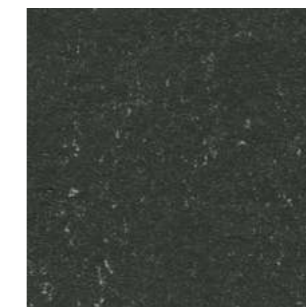

0081 Private Black
2,5 mm

Compact / Acoustic Linoleum

Uni Walton



0100 Ocean Blue
2,5 mm

^ Scale 1



0059 Frost Grey

© Celia Unalide Photog

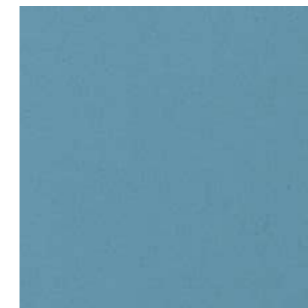

0095 Spring Blue
2,5 mm



0062 Mediterranean Orange
2,5 mm

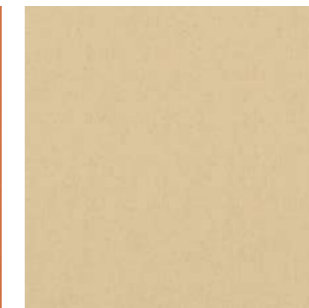

0043 Neutral Beige
2,5 mm



0059 Frost Grey
2,5 mm



0082 Broken Grey
2,5 mm



0010 Pompeji Red
2,5 mm



0085 Warm Concrete Grey
2,5 mm



0081 Nickel Grey
2,5 mm



0083 Architects Grey
2,5 mm



0088 Chestnut
2,5 mm



0090 Olive
2,5 mm



0058 Clay Grey
2,5 mm

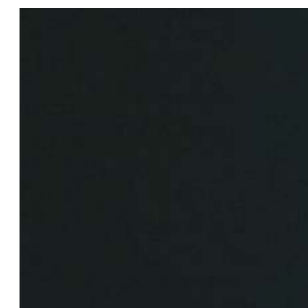

0080 Black
2,5 mm

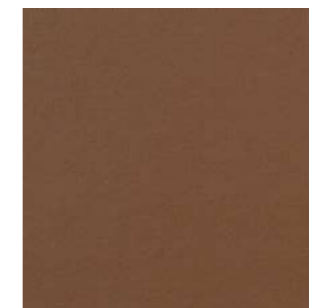

0060 Deep Brown
2,5 mm

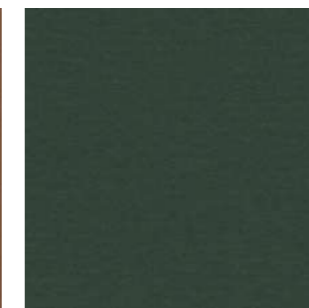

0035 Racing Green
2,5 mm

A+ AcousticPlus 19dB in stock

All other colours can be manufactured in Acoustic 15dB version. Special request - Minimum order quantity: 1500sqm. Below 1500sqm, use Korkment underlayer.
All other colours can be manufactured in Acoustic Plus 19dB version. Special request - Minimum order quantity: 58sqm

Compact / Acoustic Linoleum

Lino Art - Urban **New**

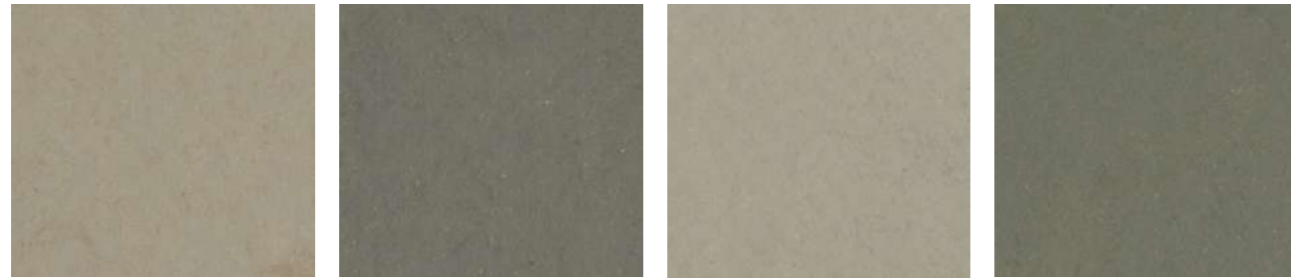

0557 Urban Grey
2,5 mm

0553 Dark Concrete Grey
2,5 mm

0560 Bold Grey
2,5 mm



0554 Concrete Grey
2,5 mm

0550 Beton Soft Grey
2,5 mm

0569 Curb Grey
2,5 mm

0583 Lily Green
2,5 mm



0552 Silver Grey
2,5 mm

0580 Bush Green
2,5 mm

0582 Stalk Green
2,5 mm



0584 Night Blue
2,5 mm

0568 Asphalt Grey
2,5 mm

0563 Zinc Grey
2,5 mm

0562 Titan Grey
2,5 mm

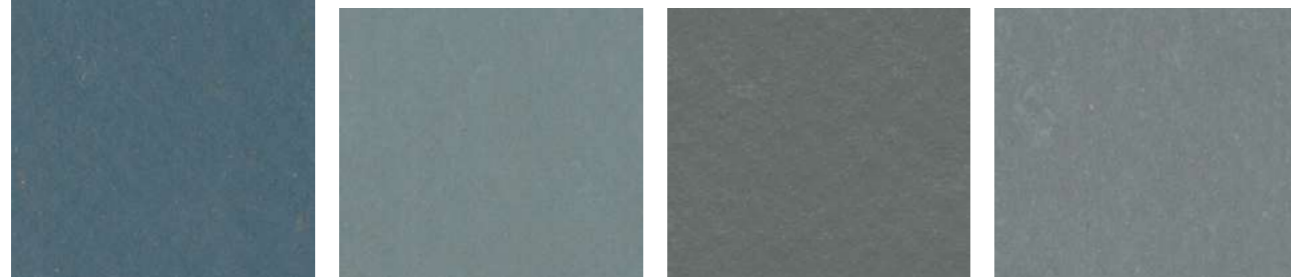

0585 Cloud Blue
2,5 mm

0565 Graphite Grey
2,5 mm

0570 Metropolis Grey
2,5 mm



0587 Sand Clay
2,5 mm

0579 City Clay
2,5 mm

0586 Light Clay
2,5 mm

0575 Powder Stone Brown
2,5 mm



0573 Brick Brown

0573 Brick Brown [^] Scale 1
2,5 mm

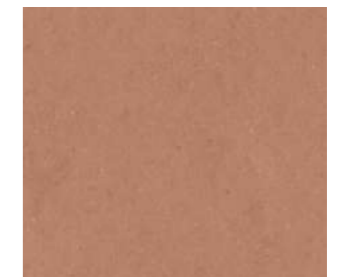

0572 Terracotta Brown
2,5 mm

0571 Tree Bark Brown
2,5 mm

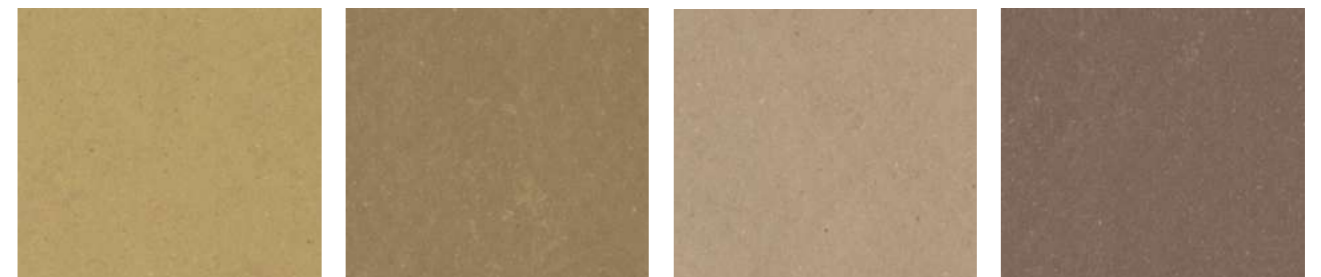

0577 Ochre Clay
2,5 mm

0576 Earth Clay
2,5 mm

0578 Marine Clay
2,5 mm

276 All colours can be manufactured in Acoustic 15dB version. Special request - Minimum order quantity: 1500 qm. Below 1500sqm, use Korkment underlayer.
All colours can be manufactured in Acoustic Plus 19dB version. Special request - Minimum order quantity: 58sqm

Compact / Acoustic Linoleum

Lino Art - Moon **New**

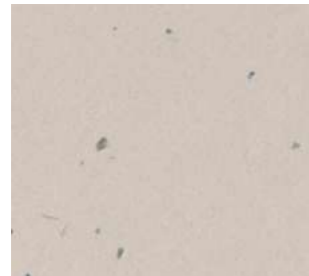

0235 Soil
2,5 mm

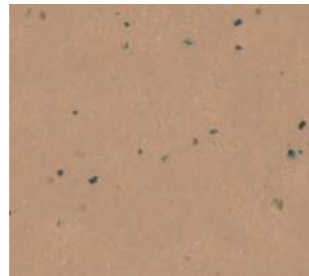

0233 Venus
2,5 mm



0232 Mercury
2,5 mm



0231 Earth
2,5 mm

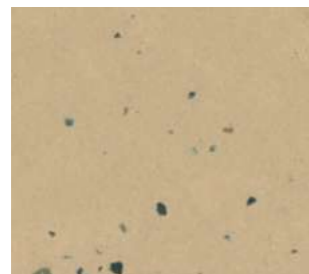

0234 Sand
2,5 mm

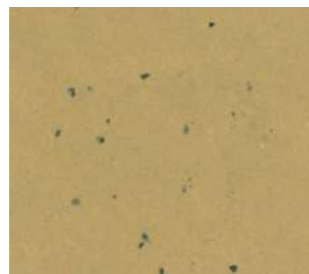

0236 Sun
2,5 mm



0243 Space



0242 Stone
2,5 mm

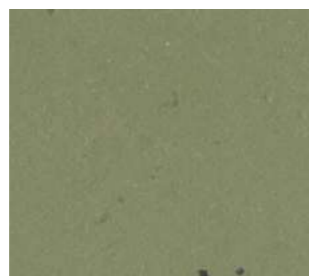

0241 Green Flash
2,5 mm

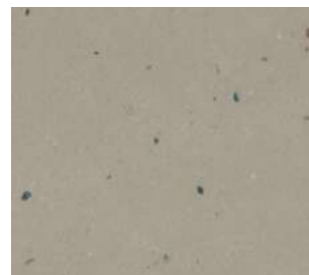

0240 Rock
2,5 mm



0238 Meteorite
2,5 mm



0237 Volcanic
2,5 mm



0239 Shadow
2,5 mm



0243 Space
2,5 mm

^ Scale 1

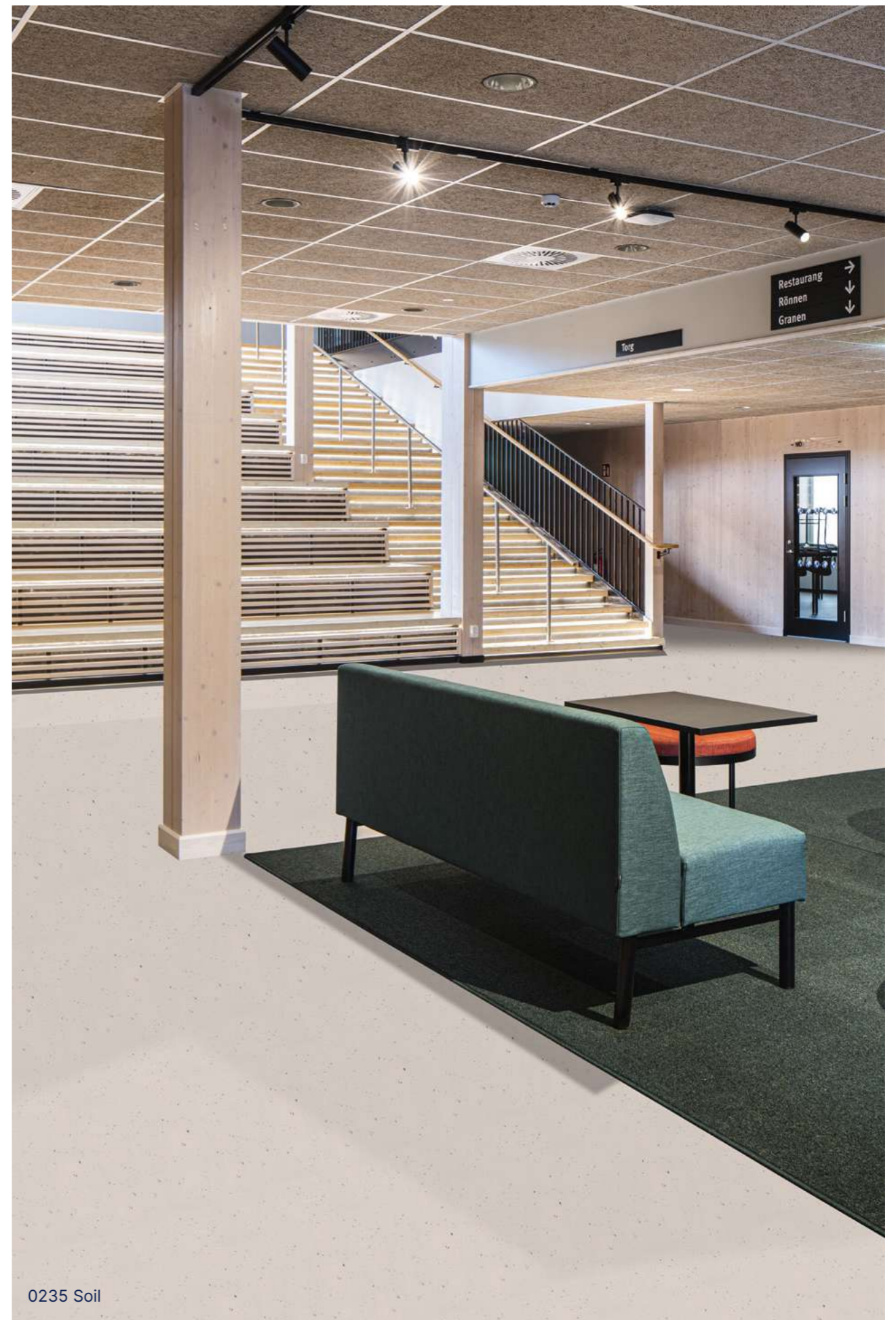

0235 Soil

278 All colours can be manufactured in Acoustic 15dB version. Special request - Minimum order quantity: 1500 qm. Below 1500sqm, use Korkment underlayer.
All colours can be manufactured in Acoustic Plus 19dB version. Special request - Minimum order quantity: 58sqm

Technic Linoleum

Linodur - High Mechanical Traffic Resistance

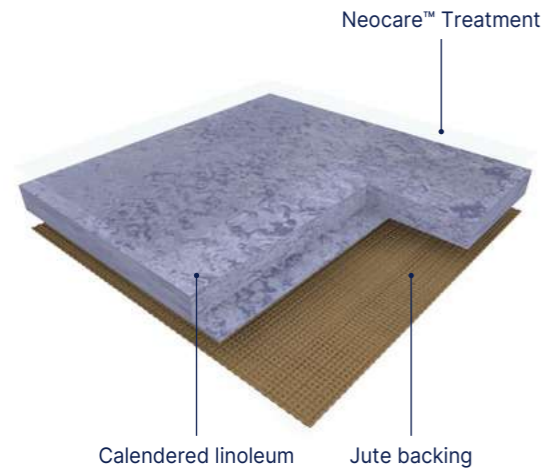

LINODUR is a calendered linoleum compact floorcovering in sheet, 2m wide, providing excellent resistance to everyday wear and tear in high pedestrian and mechanical traffic areas. Its weight is 4700g/sqm in 4.0mm. It features a discreet grain design and is composed of 98% natural materials (linseed oil, wood flour, resins, minerals coffee chaff and jute fabric) among of which 83% are rapidly renewable. The flooring is produced with Neocare™ solvent-free surface treatment, an exclusive photo-cured acrylate based lacquer surface treatment obtained by triple laser UV cross linking. Neocare™ offers excellent scratch resistance as well as resistance to chemicals found in aggressive environments such as bleach, hydro alcoholic solutions, Betadine and Eosin as well as markers making maintenance easier and increasing the life of the flooring. This treatment avoids performing any polishing throughout the lifetime of the product. It can however be polished following usual recommendations and according to the customer's wishes. The Camouflage welding rod makes the connections between the strips invisible. It is antistatic, antibacterial according to ISO 22196 / JIS Z 2801. The flooring is 100% recyclable, is composed of up to 32% recycled content, 100% controlled, is REACH compliant and rated Cfl-s1 for fire resistance. It is designed and manufactured in a sustainable way in a plant awarded with ISO 9001 (quality), ISO 14001 (environment) and ISO 50001 (energy) certifications. The Camouflage welding rod makes the connections between the strips invisible. It is antistatic, antibacterial according to ISO 22196 / JIS Z 2801.

Marmorette LCH - Dissipative Linoleum For ESD Areas

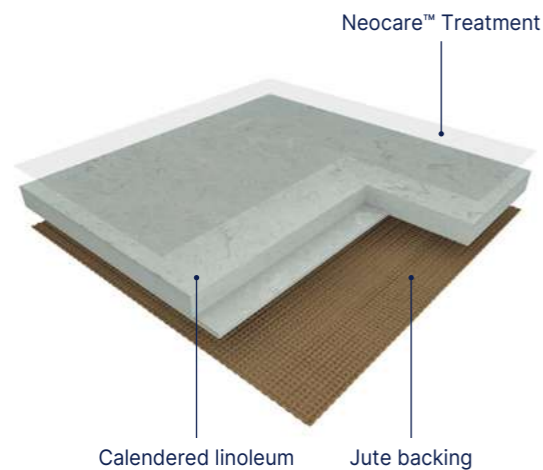

MARMORETTE LCH is a calendered linoleum compact dissipative floorcovering in sheet, 2m wide, providing excellent resistance to everyday wear and tear in high traffic areas. Its vertical resistance is $10^6 < R < 10^8 \Omega$. Its weight is 3000g/sqm in 2.5mm. It features a marbled design and presents a matt finish, is composed of 98% natural materials (linseed oil, wood flour, resins, minerals coffee chaff and jute fabric) among of which 76% are rapidly renewable. The flooring is produced with Neocare™ solvent-free surface treatment, an exclusive photo-cured acrylate based lacquer surface treatment obtained by triple laser UV cross linking. Neocare™ offers excellent scratch resistance as well as resistance to chemicals found in aggressive environments such as bleach, hydro alcoholic solutions, Betadine and Eosin as well as markers making maintenance easier and increasing the life of the flooring. This treatment avoids performing any polishing throughout the lifetime of the product. It can however be polished following usual recommendations and according to the customer's wishes. The flooring is 100% recyclable, is composed of up to 40% recycled content, 100% controlled, is REACH compliant and rated Cfl-s1 for fire resistance. It is designed and manufactured in a sustainable way in a plant awarded with ISO 9001 (quality), ISO 14001 (environment) and ISO 50001 (energy) certifications. The Camouflage welding rod makes the connections between the strips invisible. It is antistatic, antibacterial according to ISO 22196 / JIS Z 2801.

Linodur - High Mechanical Traffic Resistance



1020 Spring Blue
4.0 mm



1024 Speckled Blue
4.0 mm



1056 Marble Grey
4.0 mm



1081 Sporty Black
4.0 mm

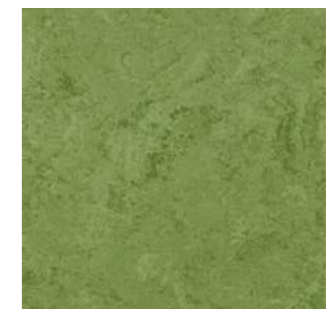

1011 Avocado Green
4.0 mm

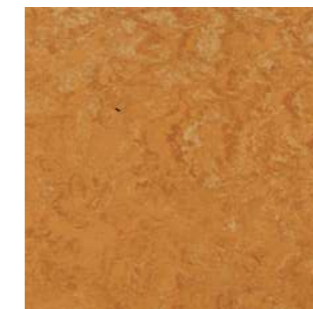

1072 Peach Orange
4.0 mm

Marmorette LCH - Dissipative Linoleum for ESD areas



0020 Spring Blue



0023 Dusty Blue
2.5 mm



0055 Ash Grey
2.5 mm

Finishes

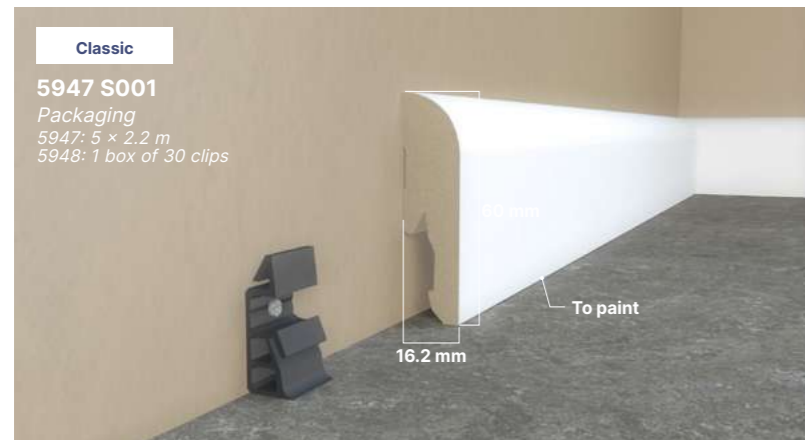

Skirtings mdf

Color: White



Skirtings cove former

Color: 6512

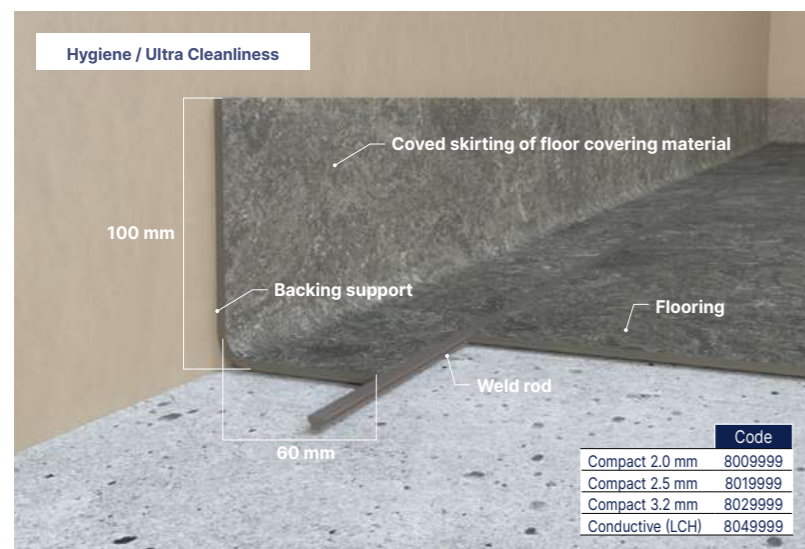

Skirtings HSLA

Welding rods

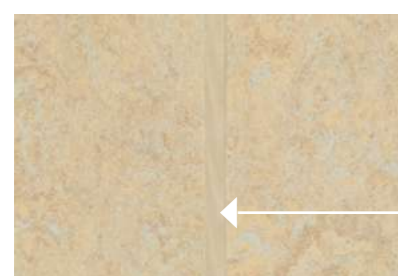

Marmorette & Linodur

Camouflage welding rod:
invisible joints



Colorette, Uni Walton & Lino Art

Uni welding rod:
a large palett of colours

Welding rod matching table available on: gerflor.com

Cleaning Neocare™-Treated Linoleum Floors

Marmorette / Colorette / Uni Walton / Lino Art



Damp sweeping equipment
Flexible mop preferably fitted with single-use antistatic and/or pre-impregnated mop pads



Manual cleaning equipment
Flat mop and washable microfinber pad



Mechanical cleaning equipment
Auto scrubber, rotary cleaner or single-brush machine



Steam cleaning equipment
Follow the manufacturer's recommendations



Mechanical cleaning disk
3M colour discs or equivalent / melamine discs



3M red rectangular pad or equivalent, or melamine rectangular pad
Can be used with or without pad holder and telescopic handle

	Equipment used	Cleaning products	Cleaning methods
First use	+ + Melamine disc if very soiled	Water without detergent	<ul style="list-style-type: none"> Damp sweeping Mechanical cleaning with melamine disc at 150-300 rpm (with water recovery)
Mechanical cleaning	+ + OR or if soil	Neutral detergent or Alkaline detergent	<ul style="list-style-type: none"> Damp sweeping Mechanical cleaning at 150-300 rpm (with water recovery)
Regular cleaning	+	Water or, if necessary Neutral detergent / Disinfectant detergent / Cleaning care product	<ul style="list-style-type: none"> Damp sweeping Manual cleaning with flat mop and microfiber
Manual cleaning	+ + OR or light green	Water or, if necessary Neutral detergent / Cleaning care product	<ul style="list-style-type: none"> Damp sweeping Mechanical cleaning at 150-300 rpm (with water recovery)
Mechanical cleaning			<ul style="list-style-type: none"> Follow the supplier instructions
Deep cleaning		Water or neutral detergent	<ul style="list-style-type: none"> Damp sweeping Manual cleaning with rectangular melamine pad Rinsing with clean water
Manual cleaning		Alkaline detergent	<ul style="list-style-type: none"> Damp sweeping Manual cleaning with red rectangular pad Rinsing with clean water
Mechanical cleaning	+ + OR or light green	Alkaline detergent	<ul style="list-style-type: none"> Damp sweeping Mechanical cleaning at 150-300 rpm (with water recovery) Rinsing with clean water
Mechanical cleaning	+ + Melamine disc	Water or neutral detergent	<ul style="list-style-type: none"> Damp sweeping Mechanical cleaning with melamine disc at 150-300 rpm (with water recovery)

These cleaning instructions have to be adapted depending on traffic and location of the area.

Gerflor DLW flooring products are to be installed in full accordance with Gerflor DLW installation instructions and recognized trade standards.

An effective, regular cleaning and maintenance program is vital for retaining a high appearance level. Gerflor DLW flooring products should only be used as floorcoverings.

Note: Gerflor DLW reserve the right to amend this specification without giving prior notice. For the latest versions of the technical specifications, check our website: www.gerflor.com

INSTALLATION & MAINTENANCE GUIDELINES AVAILABLE ON GERFLOR.COM





Sports Floorings

pages 284-329

- 290. **Taraflex®**
Synthetic Sports Floorings
- 312. **Connor Sports® Aspire | New**
Engineered wood Flooring System
- 316. **Sport Court®**
Outdoor Surfaces
- 322. **DLW**
Linoleum Sports Floorings
- 326. **Powershock**
Fitness Rubber Solutions
- 329. **Our solutions for yor fitness center**

Gerflor, where champions play



Indoor synthetic floors: the best performing products on the market

Taraflex® has been one of the pioneer in 1947 when developing synthetic floors and is today the world leading brand for indoor sports floor.

With a complete range of products, Gerflor offers the perfect solution adapted to all users and usages, from low impact activities through to elite and performance sports. Gerflor sets itself the highest standards when it comes to the environmental quality of its products.

Made in France 

Taraflex® sport floors are recognised all over the world

Every day more than

8 millions children play on a Taraflex® sports floor.

Per year,

3 500

high level competitions are played on a Taraflex® sports floor.



Engineered wood flooring systems: more than 100 years of experience



Founded in 1872, Connor Sports® is the market leader in portable and permanent hardwood sports flooring systems. Connor Sports® professional engineers lead the industry in new product design and development, setting the standard for innovative solutions in sports surfacing. In 1914, Connor Sports® installed the first basketball court in the USA. In the late 90's, Boston Celtics selected Connor Sports® to repurpose their famed parquet into a portable flooring system.

Please check availability in your zone with your local representative.



Outdoor surfaces: world's leading outdoor sport surface



In 1974, Sport Court® created the outdoor game court. Since then, over 150,000 courts have been installed worldwide.

Sport Court®'s superior outdoor play surface is designed to:

- keep athletes safe
- allow for year-round sports activity
- eliminate costly annual maintenance



Indoor sport areas: historic leader in linoleum sport flooring

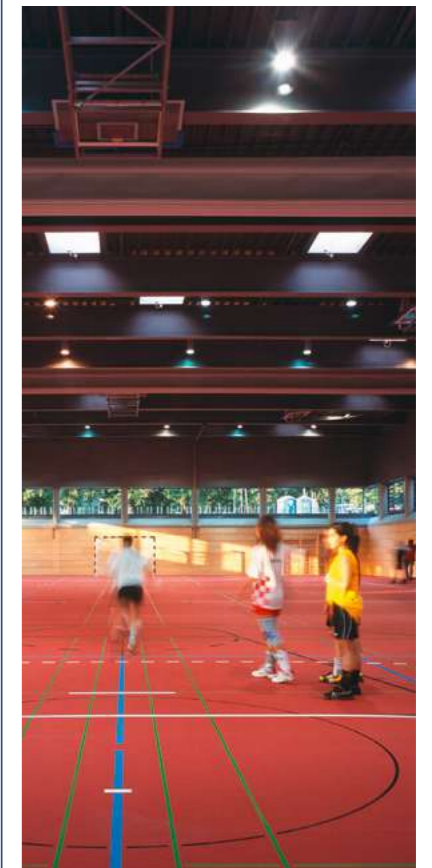

DLW Linoleum has been manufacturing high class sport linoleum for over 30 years and is proud to deliver uncompromising product quality. Adapted to both specific and multi-function use, linoleum high performance floors are a great option to address various applications, from kindergartens to multipurpose halls and fitness centres. Thanks to its acknowledged sustainable features, millions of square metres of sport linoleum have been installed over the years and still convince new generations of users.

Partner of major events

Official and exclusive floor supplier

Taraflex® has become the trusted historical partner to a host of well-known major international sporting federations, delivering exclusive partnerships which demonstrates Gerflor's position as a worldwide leader in sports flooring.



Gerflor, supplier of major international sports events



Sport is a catalyst for values such as solidarity and unity. At Gerflor, we embody these principles by designing Taraflex® sports flooring to promote an inclusive experience. We are proud to promote inclusion by designing products for Paralympic sports such as sitting volleyball and boccia. It enables everyone to actively participate and feel valued in the world of sport.

"Gerflor Taraflex® is an amazing floor. Our athletes look forward to playing on this surface. They tell me they can move well because it slides well. They also appreciate the padding on the floor. It takes a lot of pressure off their shoulders, arms, and hands when they move. It is a fantastic floor for sitting volleyball!"

Bill Hamiter, Women's Head Coach/Program Director, Sitting Volleyball USA National Team.



Taraflex® Sport Floors

Why should you choose Taraflex®?

Sports floors are classified into 3 categories:

- Point-elastic floors such as Taraflex® sports floors
- Area-elastic floors such as sprung wooden floors
- Combined floors, providing a combination of point-elastic and area-elastic floor features

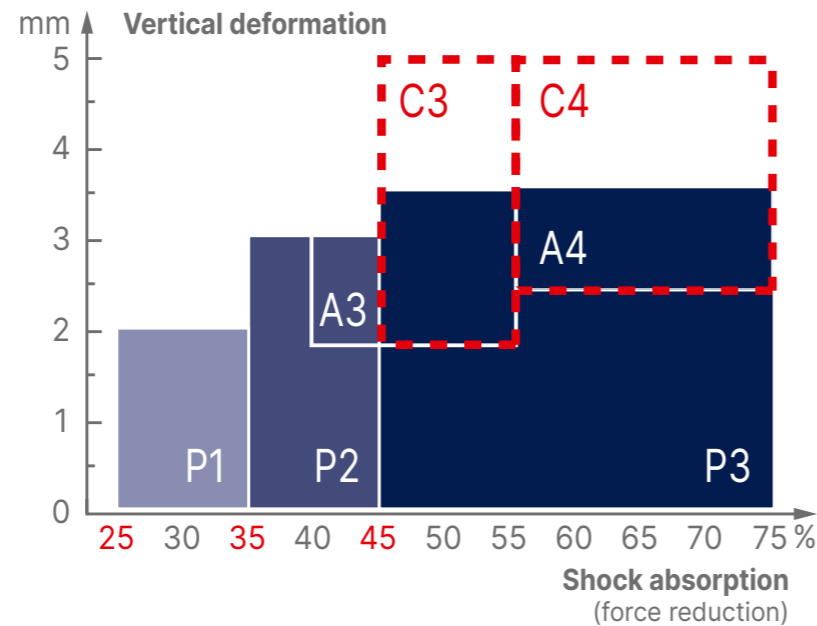

The objective of the European sport standards EN 14904 is to draw attention to the necessity of installing safe, comfortable floors. The purpose of a sports floor is to minimise the force of impact on the body and reduce the risk of long-term injury. This property is called safety and is measured by shock absorption.

EN 14904 determines shock absorption classes for all floors. A floor needs to provide minimum 25% shock absorption to be considered a sports floor.

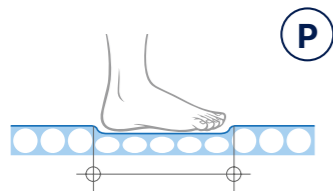

Adapted to the greatest number of players (children, teenagers, adults) and sports activities

Point-elastic floors

Point-elastic floors compress around the impact point to absorb the force of the impact. Point-elastic material deformation is a comfort indicator and makes this kind of floor particularly adapted to children. These properties make it more comfortable to walk and run, for every players.

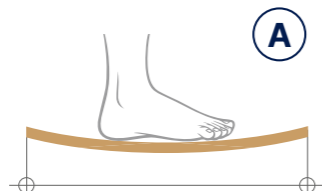

Adapted to rolling sports and high-level basketball practice

Area-elastic floors

Engineered to disperse impact energy across a wider surface area, these area-elastic floors offer athletes superior energy restitution, ensuring peak performance with every move. Plus, their unmatched ball bounce makes them the ultimate choice for top-tier sports facilities.

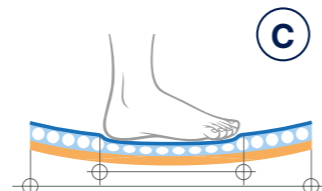

Adapted to intense to high-level practice

Combined floors

Combined floors are the association of a point-elastic floor and an area-elastic floor. They combine shock absorption and elasticity properties of these two categories. For example, Subflex Taraflex® Evolution is in this category, by association of Taraflex® Evolution, point elastic floor and Subflex cushioning wood subconstruction with foam.

For protection

The floor that brings immediate protection on impact to all users when falling, diving or sliding on the floor.

Gerflor offers Taraflex® Comfort a P3 floor with the highest level of comfort on the market.

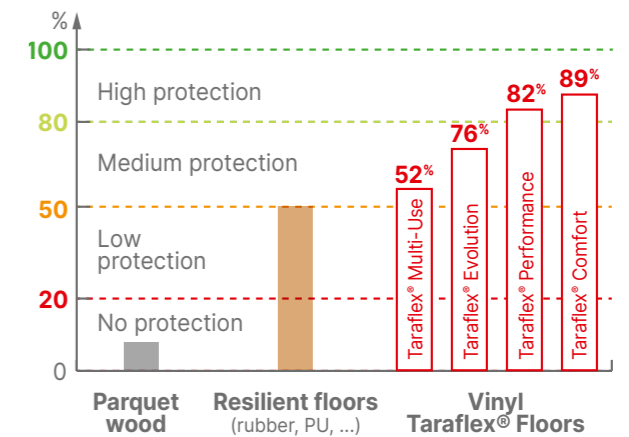

For safety

Shock absorption **minimises the force** of impact on the body and reduces long term injury risk.

With a complete range of shock absorption P1/P2/ P3, Gerflor provides the right solution and the best safety for every user.

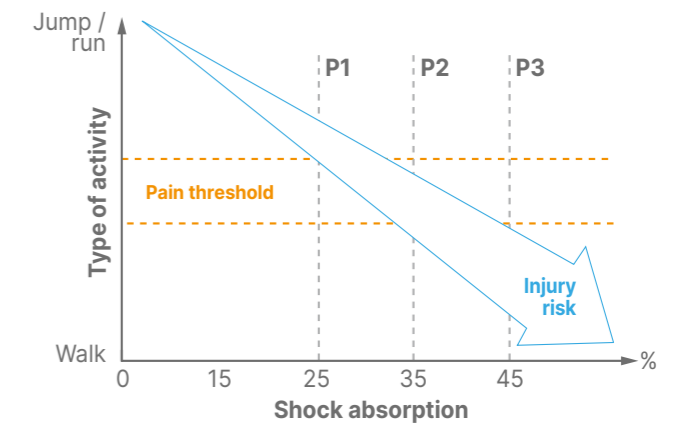

For durability

Taraflex® technologies ensure long-lasting **High Performance**

Gerflor guarantees the category P1/P2/P3 after 15 years use*.



"I have been Product Development Manager at Gerflor for 12 years. My constant objective has always been to meet the needs of the market and ensure the satisfaction of our sports customers. To achieve this, I work closely with the technical teams to design and continuously improve our products. Recently, we developed the new Taraflex® products, taking care to incorporate bio-sourced content while maintaining our quality standards."

R&D - Gerflor

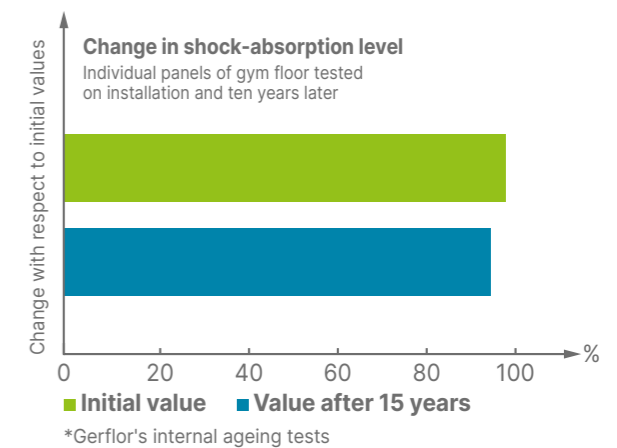

*Gerflor's internal ageing tests

Taraflex® Sport Floors

Why should you choose Taraflex®?

Sport floors are classified into 2 different levels of versatility:

- Light versatility
- Heavy versatility

Heavy or light versatility is determined by the weight of the sports and extra-sports equipment used and the duration of the load.

Light Versatility

Rule of the light versatility according to the standard EN 14904

- Weight: <10 kg/cm²
- Duration of non-sport activities solicitation: 5h



Chair occupied
up to 100 kg

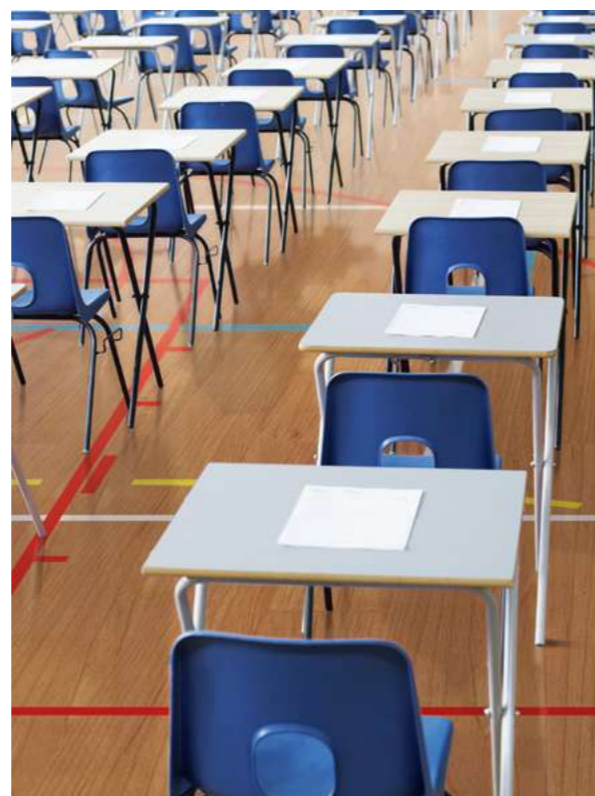

Heavy Versatility

Rule of the heavy versatility

- Weight: 10 to 50 kg/cm²
- Duration of non-sport activities solicitation: 12h to 24h



Bleacher
up to
1500 kg



Platform
380 kg



Concert
scene
500 kg



Machine on 4 wheels
up to
2000 kg



IPI: Impact Protection Index

Protection is the property of the floor that reduces immediate injuries when falling, diving, sliding on the floor for all users (children, adults, athletes...)

Protection is not considered by EN 14904 but is an important criteria, as in many instances sports floors are used for educational purposes.

Gerflor measures protection with the Impact Protection Index and defines 3 categories of protection:

IPI = Impact Protection Index

≤ 50%	low protection
50% < IPI ≤ 80%	medium protection
> 80%	high protection

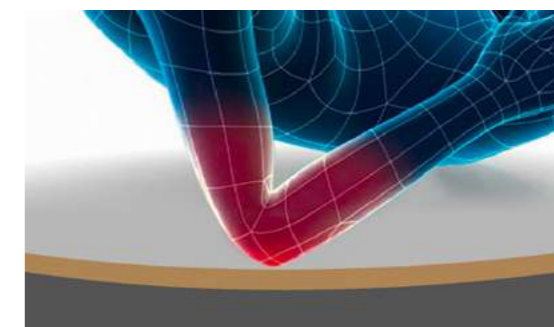

Small surface impact area, **low IPI floors**, high risks of immediate injuries.

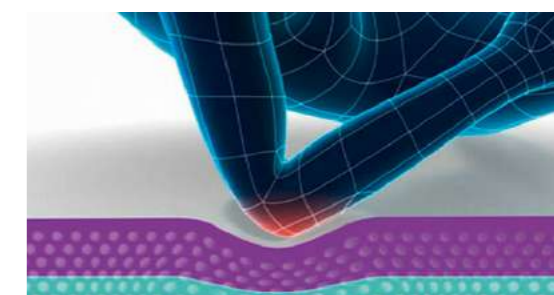

High impact surface area, **high IPI floors**.



Choosing a sports floor requires a good understanding of the usage of the sports hall:

- Type of users: from children to high level athletes
- Type and variety of sports
- Type of sport equipment: tennis or volleyball posts, gym equipment, ...
- Use for activities other than sport: exams, concerts, requiring other specific equipment

Taraflex® Sport Floors

Champions in Sustainability

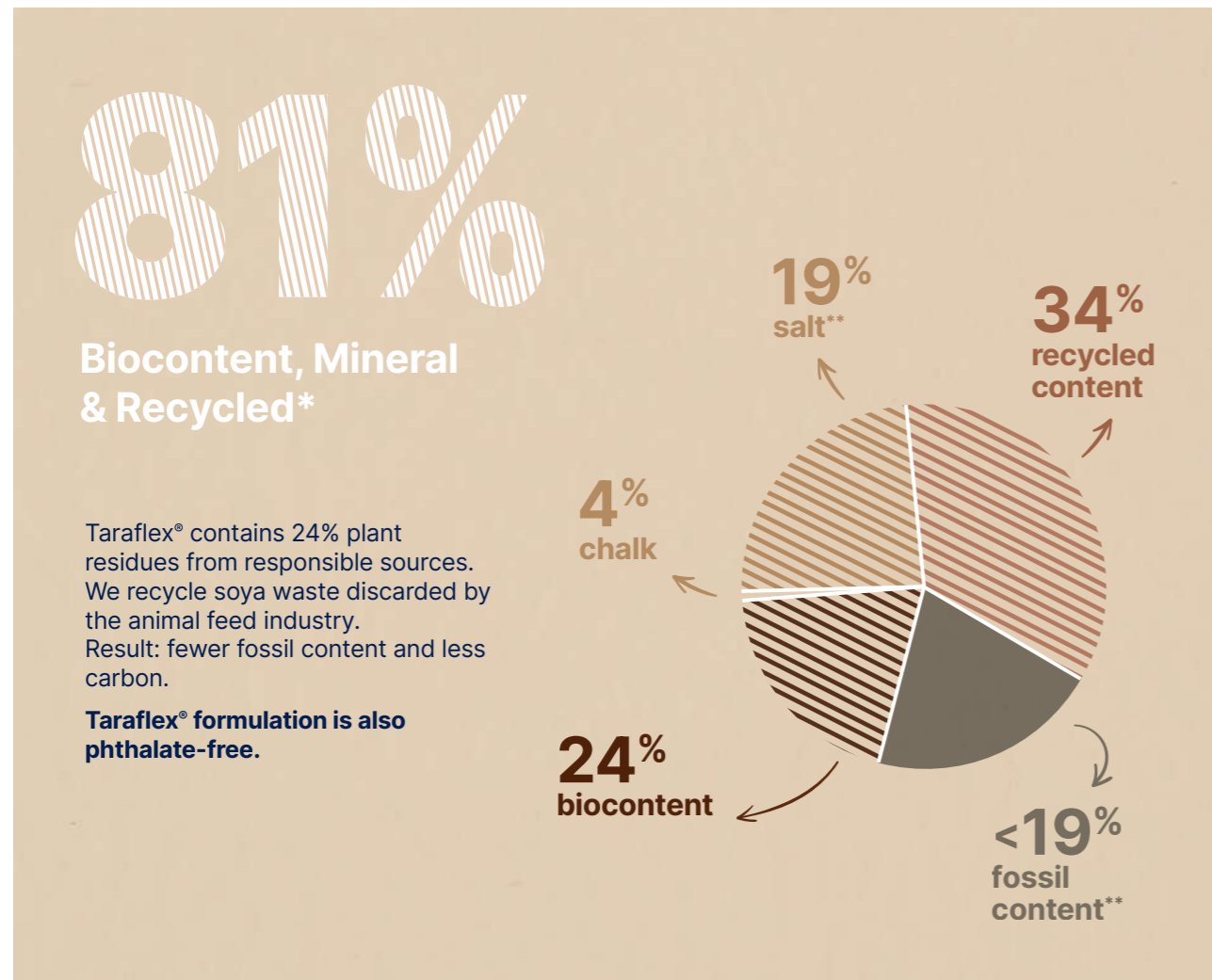

Best in class carbon footprint



Thanks to 360° eco conception, Taraflex EPD is the lowest of the sports flooring market.

A good choice for decarbonising your projects.

100 % recyclable



All Gerflor floorings are 100% recyclable and eligible to **Gerflor Second Life collection and recycling program**. Free collection of installation waste is available in 10 countries.

The secret of Taraflex® Sport Flooring

1 ProtecSol®

An intelligent surface with the unique and patented triple action ProtecSol®:

- Best solution to maximise both slide and grip
- A friction-burn free surface, on which the temperature during a fall is reduced by 25%
- Cost effective and easy to maintain

2 D-Max™

D-Max™ surface is a UNIQUE complex made of calendered PVC sheets reinforced with a fibreglass grid.

- High durability
- Outstanding dimensional stability

3 CXP™ HD

Taraflex® CXP-HD dual-density foam provides shock absorption for ideal player protection and safety.

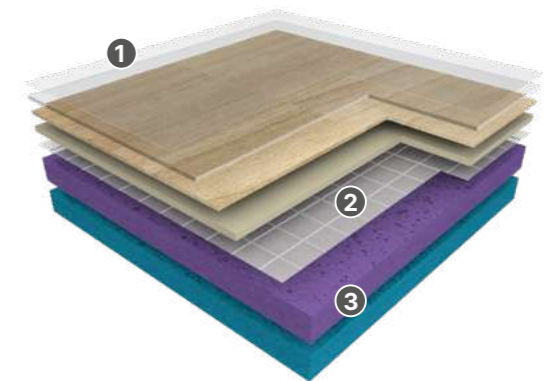

4 different foams

Low Density	Density +	Density ++	Density +++
Lightness	Elasticity	Energy restitution	Compactness

3 types of products

Indentation resistance & Performance

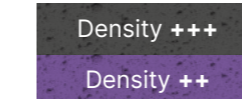

CXP™ HD+

Taraflex® Multi-Use

Performance & Safety

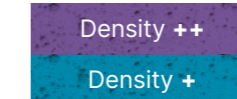

CXP™ HD

Taraflex® Evolution
Taraflex® Performance

Safety & Protection

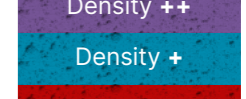

CXP™ HD

& Polyolefin foam

Taraflex® Comfort



"I'm committed to listening carefully to our customers to find solutions to their problems, while promoting Taraflex®, 'the floor of champions'. Whether young, amateur, professional or senior, I believe that every player has the right to the best possible floor. This conviction has driven my daily work for the past 7 years, to continue to offer excellence and create great experiences of conviviality, pleasure and optimal performance over time on #Taraflex®."

Sports Product Marketing Manager

*Taraflex® Evolution solid colours

** Vinyl is made from two primary ingredients: salt (abundant mineral) and ethylene (fossil)

Taraflex® Sport Floors

How to choose the right floor?

Multi Sport, Education, Club & Competition

Taraflex® Evolution

The reference in sports flooring

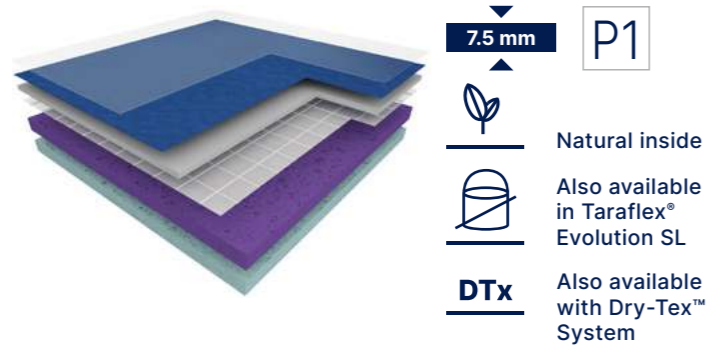

Taraflex® Performance

Best balance of sport performance and safety

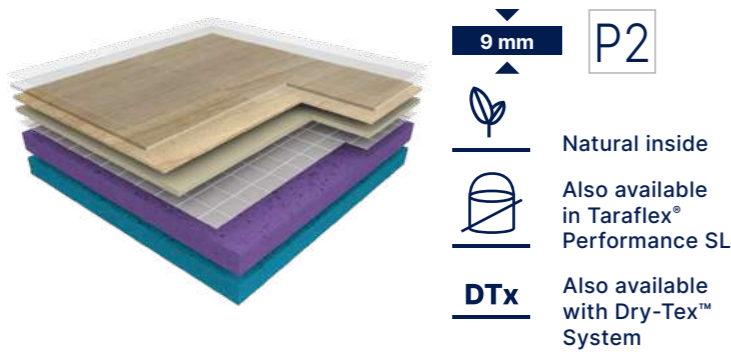

Taraflex® Comfort

Maximum protection & safety

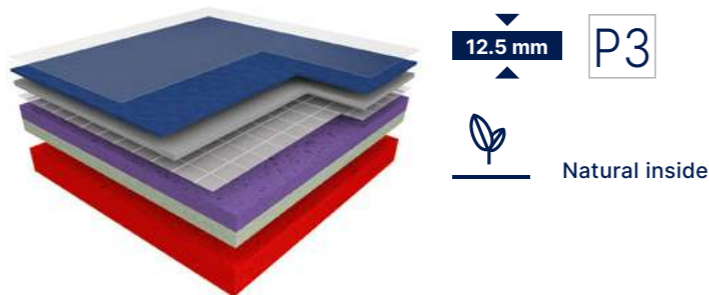

Multi Purpose, Sport & Non-Sport Activities

Taraflex® Surface

Compact surface, to be used alone or on sub-construction*

*Meets EN14904 with sub-construction

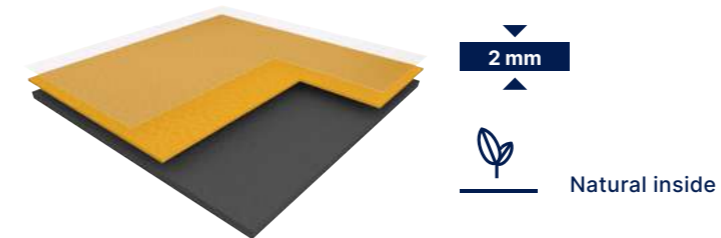

Taraflex® Multi-Use

Performance & very high indentation resistance

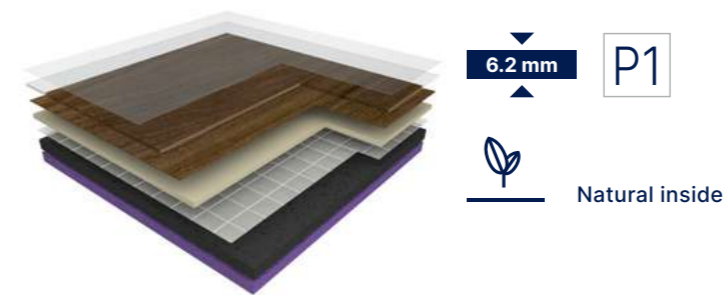

	Basketball	Volleyball	Handball	Netball	Floorball	Futsal	Table Tennis	Badminton	Multi-sports	Rolling Sports & Wheel sports	Disability sports	Heavy versatility	Light versatility
Taraflex® Evolution (P1)	■	■	■	■	■	■	□	■	■	□	×	×	■
Taraflex® Performance (P2)	□	■	■	■	■	■	×	□	■	□	□	×	□
Taraflex® Comfort (P3)	×	□	□	□	□	□	×	□	■	×	■	×	×
Taraflex® Multi-Use (P1)	□	□	□	□	□	□	■	■	■	■	×	■	■
Taraflex® Surface	■	□	□	□	□	□	□	□	■	■	×	■	■

Installed over undercarriage system

■ = Recommended / □ = Possible / × = Not recommended

Taraflex® Sport Floors

Smooth Harmony

Taraflex® Surface, Taraflex® Evolution, Taraflex® Performance, Taraflex® Comfort



Ecru



4345 - Ecru / Y = 52.7

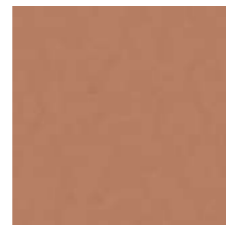

6348 - Clay / Y = 23.1



6553 - Fern / Y = 20.9

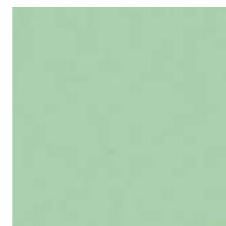

0654 - Sage / Y = 43.6



0047 - Mallow / Y = 41.6



« Sport and well-being has become an essential part of our daily lives, the balance between physical and mental fitness is like a rule of life for some people.

This new palette of softer, more contemporary colours create the right ambience for users looking for places that combine sport and relaxation but also to the expectations of architects for new sports complexes, which are often increasingly integrated into the environment.

The two new shades of green (sage and fern) are much closer to the shades found in nature and can be blend perfectly with our wood designs.

Terracotta (clay) is a colour that has been used for a long time in many sports surfaces such as tennis and athletics and this earthy colour provides a reassuring touch.

We've reworked beige (new ecru) to make them more neutral and blend in with all the other colours. Mauve (mallow) is the palette's funniest, trendiest touch. »

Designer - Gerflor

Timeless Nature

Taraflex® Surface, Taraflex® Evolution, Taraflex® Performance, Taraflex® Comfort



6350 - Light Cherry / Y = 43.3

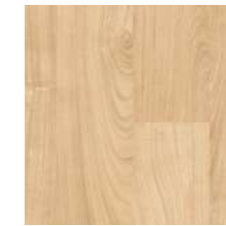

Scan scale: 25%



5742 - Wood Oak / Y = 27.8

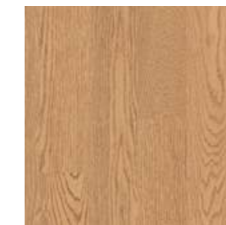

Scan scale: 25%



5763 - Maple Sun / Y = 40.2



Scan scale: 25%



6379 - Maple Desert / Y = 23.2



Scan scale: 25%



Light Cherry & Wood Oak

Taraflex® Sport Floors

Colourful Games

Taraflex® Surface, Taraflex® Evolution, Taraflex® Performance, Taraflex® Comfort



2404 - London Light Blue / Y = 33.8



6431 - Teal / Y = 19.2

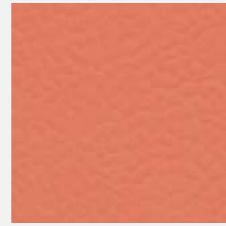

6146 - Coral / Y = 27.8



6038 - Terracotta / Y = 19.9

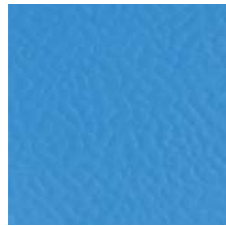

6445 - Lagoon / Y = 24.9



6570 - Mint Green / Y = 16.6



6211 - Gold / Y = 41.5



6180 - Red / Y = 9.8



6430 - Blue / Y = 8.0



6873 - Anthracite / Y = 20.5



6758 - Silver Gray / Y = 32.6

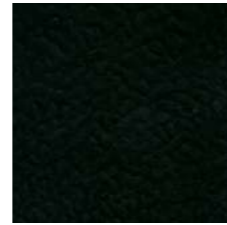

6830 - Black / Y = 3.1



© Volleyball World - Courtesy

Teal / Coral

Masking designs for multi-use

Taraflex® Multi-Use



6844 - Black Strips / Y = 14.5



6391 - Maple Stone / Y = 30.6

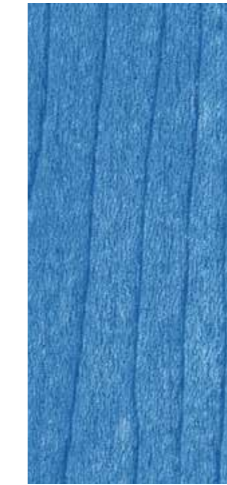

6373 - Maple Ocean / Y = 21.1



6392 - Maple Earth / Y = 10.2



6379 - Maple Desert / Y = 23.2



2790 - Polished Concrete Dark Grey / Y = 15.3



2791 - Polished Concrete Light Grey / Y = 27.4



6350 - Light Cherry Design / Y = 43.3



5742 - Wood Oak / Y = 27.8



7762 - Pure Concrete Blue / Y = 12.5



7764 - Pure Concrete Lagoon / Y = 28.7



6445 - Lagoon / Y = 24.9



6873 - Anthracite / Y = 20.5



6180 - Red / Y = 9.8

Taraflex® Sport Floors

Specific applications racket sports

- Racket sport floors should offer an excellent compromise between slide and grip for lateral moves, accelerations and changes of direction.
- Gerflor offers a complete range of solutions for racket sports with different types of installation methods (portable and permanent floors) to meet player's expectations and facilities needs.

Taraflex® Table Tennis

Engineered and developed in partnership with the International Table Tennis federation (ITTF)

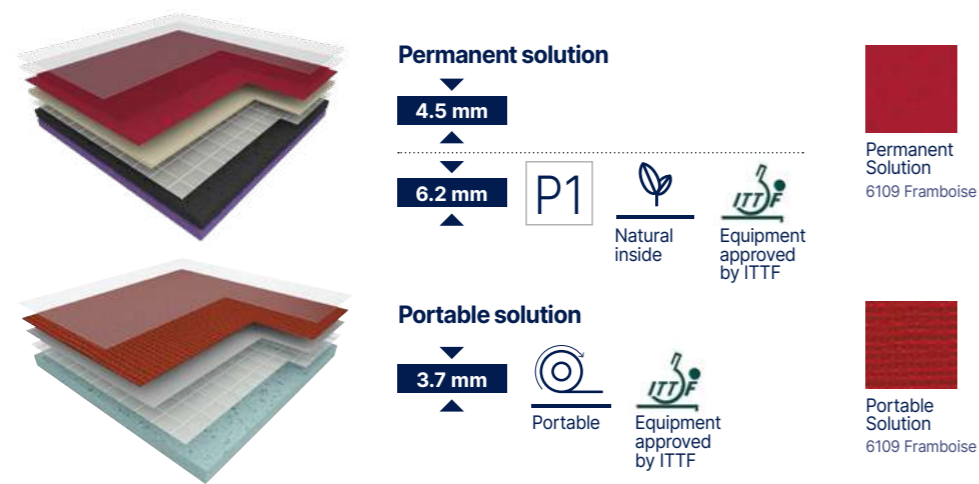

Taraflex® Badminton

The ultimate floor for badminton movements

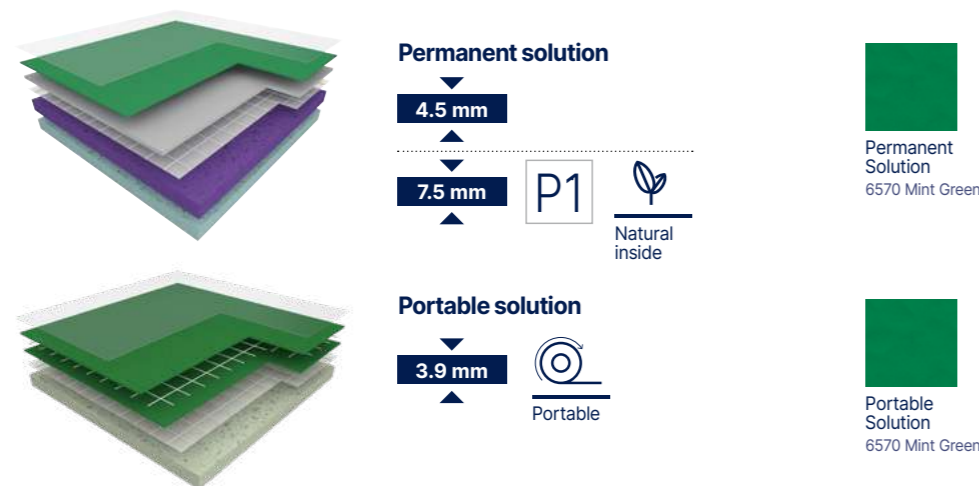

A sub-construction for each usage

Subflex **New**

SUBFLEX is a sports sub-construction that can be combined with a floor covering of your choice. It consists of an 18.8mm wooden panel, shock-absorbing and energy-releasing foam, and a protective layer against rising damp. These complete and combined assemblies ensure excellent sporting performance for athletes, as this sub-construction offers unrivalled stability and solidity.

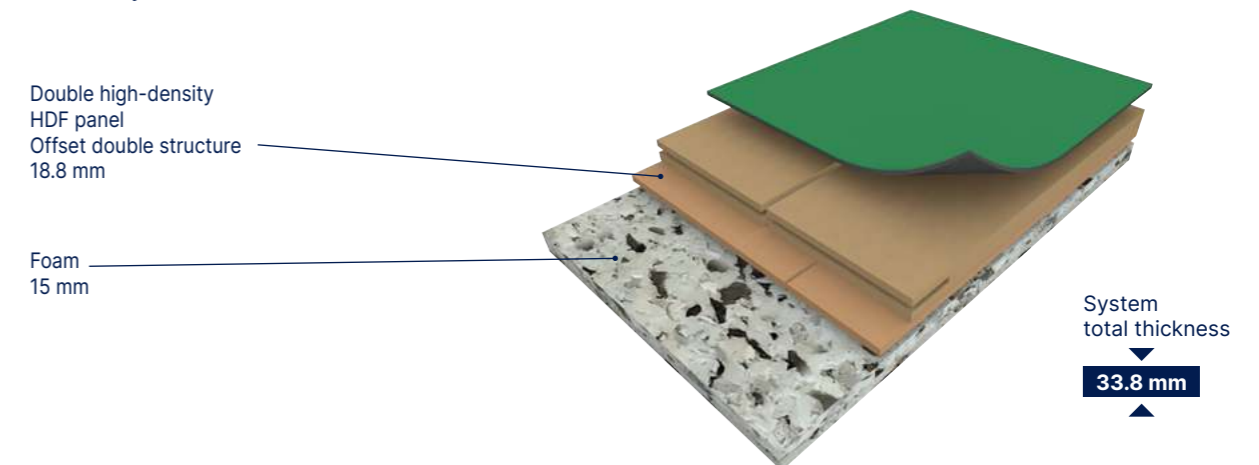

Subflex benefits



Resistance against humidity rises, up to 7%



Wide ranges of designs for an **ultra-realistic wood aspect**



No need to sand or treat joints before surface flooring installation: **easy installation**

GERFLOR SOLUTION



Offset double-layer structure that enables a full assembly coverage: **solidity, stability and superior resistance to static and rolling loads**

Available with Taraflex® Evolution, Taraflex® Surface, Taraflex® Multi-Use, Linodur Sport, Marmorette 3.2.

OTHER MARKET SOLUTIONS



High-density surface with 900 kg/m³ HDF: **resistance to impact, static and rolling loads**



"With SUBFLEX, we've developed a simple, high-performance sub-construction that's easy to install and allows a wide range of sports floors to be combined for an optimised playing experience."

Sports Product Manager

Taraflex® Sport Floors

Taraflex® technologies

Gerflor has developed durable technologies to cover all types of installation, responding to the constraints of substrates, such as humidity, for renovation or temporary installation. These technical solutions can be combined with the products in the range to ensure the best performance, while preserving the sporting characteristics of Taraflex® floors.

Adhesive free sustainable installation

Taraflex® SL

SL® is an installation technology that works in conjunction with our Taraflex® floors.

This installation does not require any adhesive meaning an easier, faster and more sustainable installation without compromising sport performances and quality.

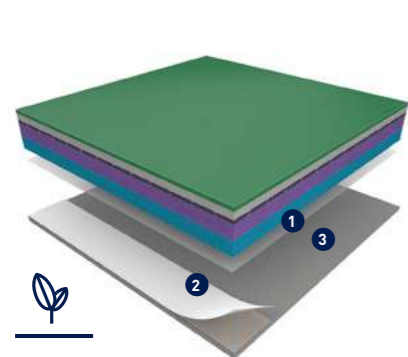

Natural inside

- 1 **Taraflex® sports flooring with reinforced textile backing**
Improved dimensional stability allowing for the only true adhesive-free sports floor installation including onto damp sub-floors with up to 7%.
- 2 **Long-lasting Tarafix® SL holding strips**
Strips installed under welded seams and floor perimeter to provide optimal stability and durability.
- 3 **Concrete slab**



Choose the SL solution, a smart choice representing 3 advantages in 1

SUSTAINABLE ADHESIVE FREE INSTALLATION

- Eliminating adhesives improves laying comfort and indoor air quality for installers and users
- Reduce the installation time

EASY RECYCLING

- Eco-design: SL textile fibers are composed of recycled plastic bottles



- Can easily be reused* or recycled



UNBEATABLE QUALITY & PERFORMANCE

- Same level of quality and performance as traditionally adhered Taraflex®
- High resistance to all sports demands
- Compliant with sub floors with up to 7% of humidity

Available with Taraflex® Evolution and Taraflex® Performance.
* Can be reused in a 10% smaller area.

Solution for damp subfloors

Dry-Tex™ System

DryTex® is an installation technology that works in conjunction with our Taraflex® floors. The action between our Gerpur adhesive and a textile backing applied under the CXP-HD foam during the manufacturing process ensures unequalled stability on very damp surfaces.

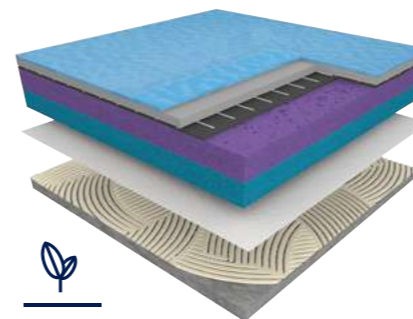

Natural inside

Available with:
Taraflex® Evolution
Taraflex® Performance

- **Cost-effective** - no need for additional moisture barriers (DPM's) saving both labour and material costs
- **Time-effective** - no need to wait for the slab to dry out
- **Greater durability and performance** - unbeatable bonding strength to the subfloor

Installation criteria:

Moisture	No limit*
Flatness	< 6mm / 3m
Surface	Hydraulic concrete**

*No surface water on the slab
**For more information contact us

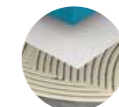

- **DTx™** textile material with CXP HD foam backing



- **GERPUR** proprietary mono component adhesive that reacts to humidity: the higher the moisture, the quicker the bonding!

Solution for cost-effective renovation works

Taraflex® Isolsport

Isolsport is a non-adhesive technical underlay that uses a foam formulation optimised and researched by the R&D department to provide technical and sporting properties suited to all types of application. This solution can be applied to damp substrates and is ideal for renovation.

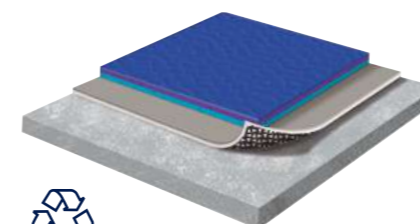

100% recyclable

Available with Taraflex® Evolution,
Taraflex® Performance, Taraflex® Multi-use (and Recreation 60)

For damp surfaces

- Loose lay installation: save money and reduce installation times by leaving the existing floor in place
- Specific texture on the backing to allow humidity to circulate: Minimizes risks from rising dampness
- Provides a complete solution for renovation and build work

Installation criteria:

Moisture	RH < 92% (BS 8203) or < 7% humidity (CCM)
Flatness	< 6mm / 3m
Surface	Hydraulic concrete / Porous subfloor

Taraflex® Sport Floors

Technical Data

Description	Standard	Requirement	Units	Taraflex® Surface	Taraflex® Multi-Use	Taraflex® Evolution	Taraflex® Performance	Taraflex® Comfort	Taraflex® Badminton			Taraflex® Table Tennis			Taraflex® Bateco	Taraflex® Isolsport	
									Portable	4.5	7.5	Portable	4.5	6.2			
Dry-Tex™ System	-	-	-	-	-			-	-	-	-	-	-	-	-	-	
Taraflex® SL (Sustainable and LooseLay)	-	-	-	-	-			-	-	-	-	-	-	-	-	-	
Product Description																	
Surface treatment	-	-	-	Triple-Action ProtecSol®	Triple-Action ProtecSol®	Triple-Action ProtecSol®	Triple-Action ProtecSol®	Triple-Action ProtecSol®	Triple-Action ProtecSol®	PUR Protect®	Triple-Action ProtecSol®	Triple-Action ProtecSol®	PUR Protect®	Triple-Action ProtecSol®	-	-	
Surface complex	-	-	-	D-Max™	D-Max™	D-Max™	D-Max™	D-Max™	100% Pur PVC	100% Pur PVC	D-Max™	100% Pur PVC	100% Pur PVC	D-Max™	-	-	
Foam	-	-	-	-	CXP-HD +™	CXP-HD™	CXP-HD™	CXP-HD™	CXP	CXP	CXP-HD™	CXP	CXP	CXP-HD+™	-	-	
Thickness	EN ISO 24346	-	mm	2	6.2	7.5	9	12.5	3.9	4.5	7.5	3.7	4.5	6.2	1.5	1.65	
Weight	EN ISO 23997	-	kg/m²	2.7	4.2	4.7	5.2	5.1	1.95	2.6	4.7	1.9	2.6	4.2	2.05	1.35	
Length*	EN ISO 24341	-	lm	26.5 Max	26.5 Max	26.5 Max	26.5 Max	26.5 Max	16 STD	26.5 Max	26.5 Max	16 STD	26.5 Max	26.5 Max	45 Max	45 Max	
Width	EN ISO 24341	-	lm	1.5	1.5	1.5	1.5	1.5	3 x 2.7	1.5	1.5	1.5	1.5	1.5	1.5	2	
Sport Properties																	
Shock absorption	EN 14808	≥ 25	%	-	P1	P1	P2	P3	-	-	P1	-	-	P1	-	-	
Vertical deformation	EN 14809	≤ 3.5	mm	≤ 2	≤ 2	≤ 2	≤ 3	≤ 3.5	≤ 2	≤ 2	≤ 2	≤ 2	≤ 2	≤ 2	-	-	
Sliding coefficient	EN 13036-4	80 to 110	-	80 to 110	80 to 110	80 to 110	80 to 110	80 to 110	80 to 110	80 to 110	80 to 110	80 to 110	80 to 110	80 to 110	-	-	
Ball bounce	EN 12235	≥ 90	%	≥ 90	≥ 90	≥ 90	≥ 90	≥ 90	-	≥ 90	≥ 90	-	≥ 90	≥ 90	-	-	
Technical Characteristics																	
Abrasion resistance	EN ISO 5470-1	≤ 1000	mg	≤ 350	≤ 350	≤ 350	≤ 350	≤ 350	≤ 350	≤ 350	≤ 350	≤ 350	≤ 350	≤ 350	≤ 300	-	
Impact resistance	EN 1517	≥ 8	N/m	≥ 8	≥ 8	≥ 8	≥ 8	≥ 8	-	-	≥ 8	-	-	≥ 8	-	-	
Indentation resistance	EN 1516	≤ 0.5	mm	≤ 0.5	≤ 0.5	≤ 0.5	≤ 0.5	≤ 0.5	≤ 0.5	≤ 0.5	≤ 0.5	≤ 0.5	≤ 0.5	≤ 0.5	≤ 0.5	≤ 0.5	
Classification																	
Fire	EN 13501-1	-	-	B _{fl} -s1	C _{fl} -s1	C _{fl} -s1	C _{fl} -s1	C _{fl} -s1	B _{fl} -s1	C _{fl} -s1	C _{fl} -s1	C _{fl} -s1	C _{fl} -s1	C _{fl} -s1	C _{fl} -s1	B _{fl} -s1	C _{fl} -s1
Anti-bacterial activity (E. coli - S. aureus - MRSA) ⁽¹⁾	ISO 22196	-	-	> 99% inhibits growth						> 99% inhibits growth							
CE Marking																	
	EN 14 904	-	-	Fire Sliding Coefficient Abrasion Resistance Rolling load Resistance	Fire Shock Absorption Sliding Coefficient Abrasion Resistance Rolling load Resistance	Fire Sliding Coefficient Abrasion Resistance Rolling load Resistance	Fire Sliding Coefficient Abrasion Resistance Rolling load Resistance	Fire Sliding Coefficient Abrasion Resistance Rolling load Resistance	Fire Sliding Coefficient Abrasion Resistance Rolling load Resistance	Fire Sliding Coefficient Abrasion Resistance Rolling load Resistance	Fire Sliding Coefficient Abrasion Resistance Rolling load Resistance	Fire Sliding Coefficient Abrasion Resistance Rolling load Resistance	Fire Sliding Coefficient Abrasion Resistance Rolling load Resistance	Fire Sliding Coefficient Abrasion Resistance Rolling load Resistance	Fire		

The proposed specifications fall within the tolerance limits usually accepted in this sector whilst still complying with standards.

(1) The implementation of an effective cleaning method is the best defence against infection

* For different roll lengths please contact us

INSTALLATION ON DAMP SUBFLOOR

Gerflor provides installation on Isolsport (free floating underlay) or Taraflex® Dry-Tex™ System or Taraflex® SL. Please contact your sales representative for more information.

Taraflex® Sport Floors

Innovative personalized services to make your floor unique

My Taraflex®



Personalize your sports floor using the digital printing process

- **Choose from collection**
choose one of our designs from our catalogue (examples shown below)
- **Change colour**
recolour the standard design of your choice
- **Customise**
create your own design

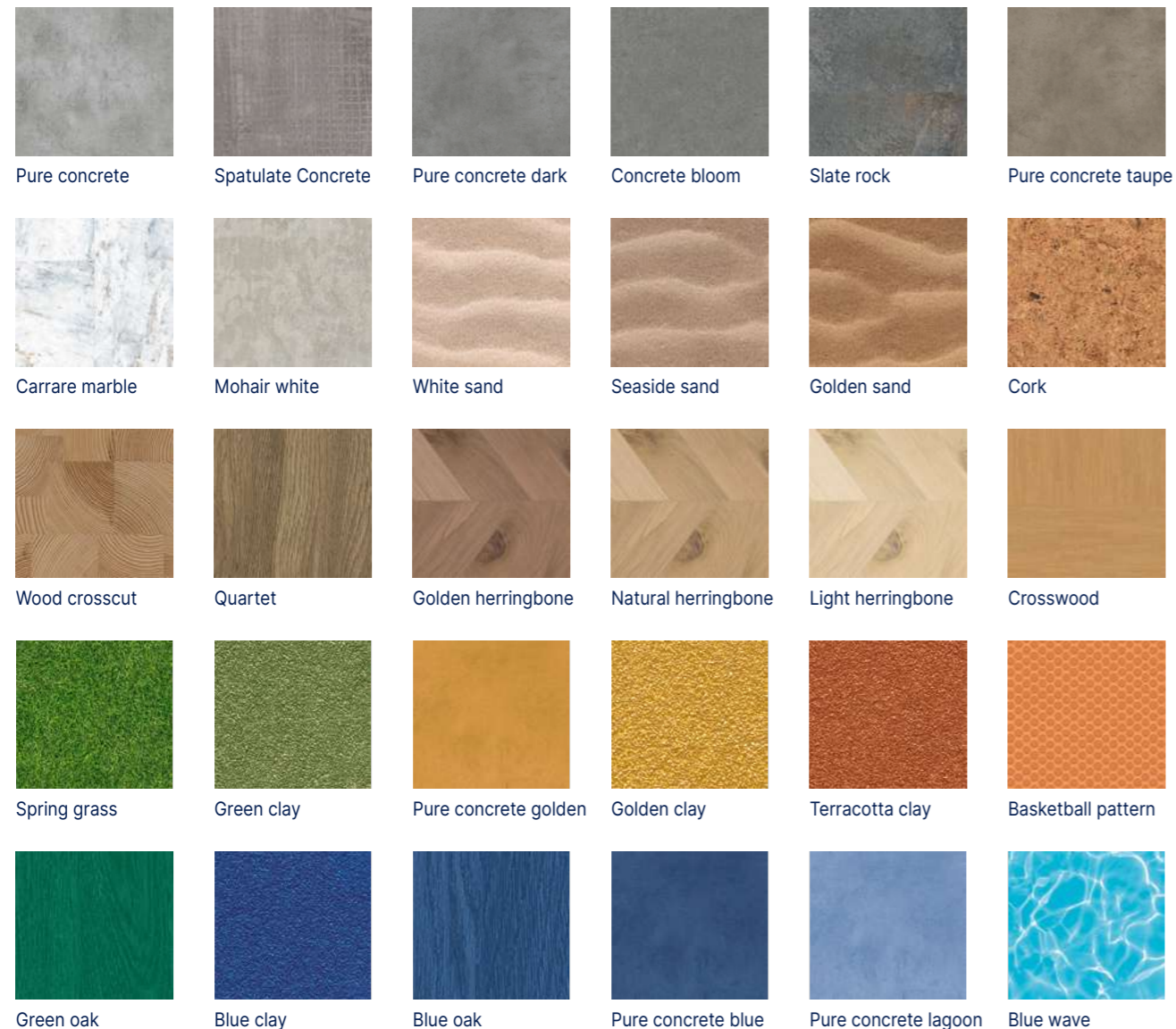

My Logo

For a stunning result

Thanks to the waterjet cutting technology, **customize your floor** with your city or club colours. For further information, please contact your local Gerflor representative.



3D court designer

This intelligent tool lets you customize the sports surface of your choice and the surrounding environment in 3 dimensions to test different pitch configurations.

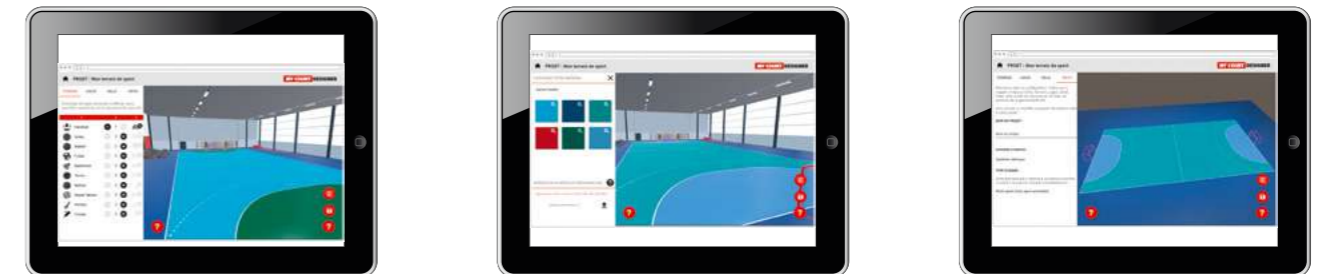

- 1 Choose your surface: monosport or multisports
- 2 Choose your colours
- 3 Visualise your sport hall

Available on: courtdesigner.gerflor.com

Interior designer

For a realistic view of your environment

This tool lets you test different sports floors in 2 dimensions with all the colours available in the range. You can also upload your own photo.



- 1 Download your picture and include the floor
- 2 Or change the floor colours in selected pictures
- 3 Visualise your sport hall

Available on: interiordesigner.gerflor.com

Taraflex® Sport Floors

A wide range of complementary solutions

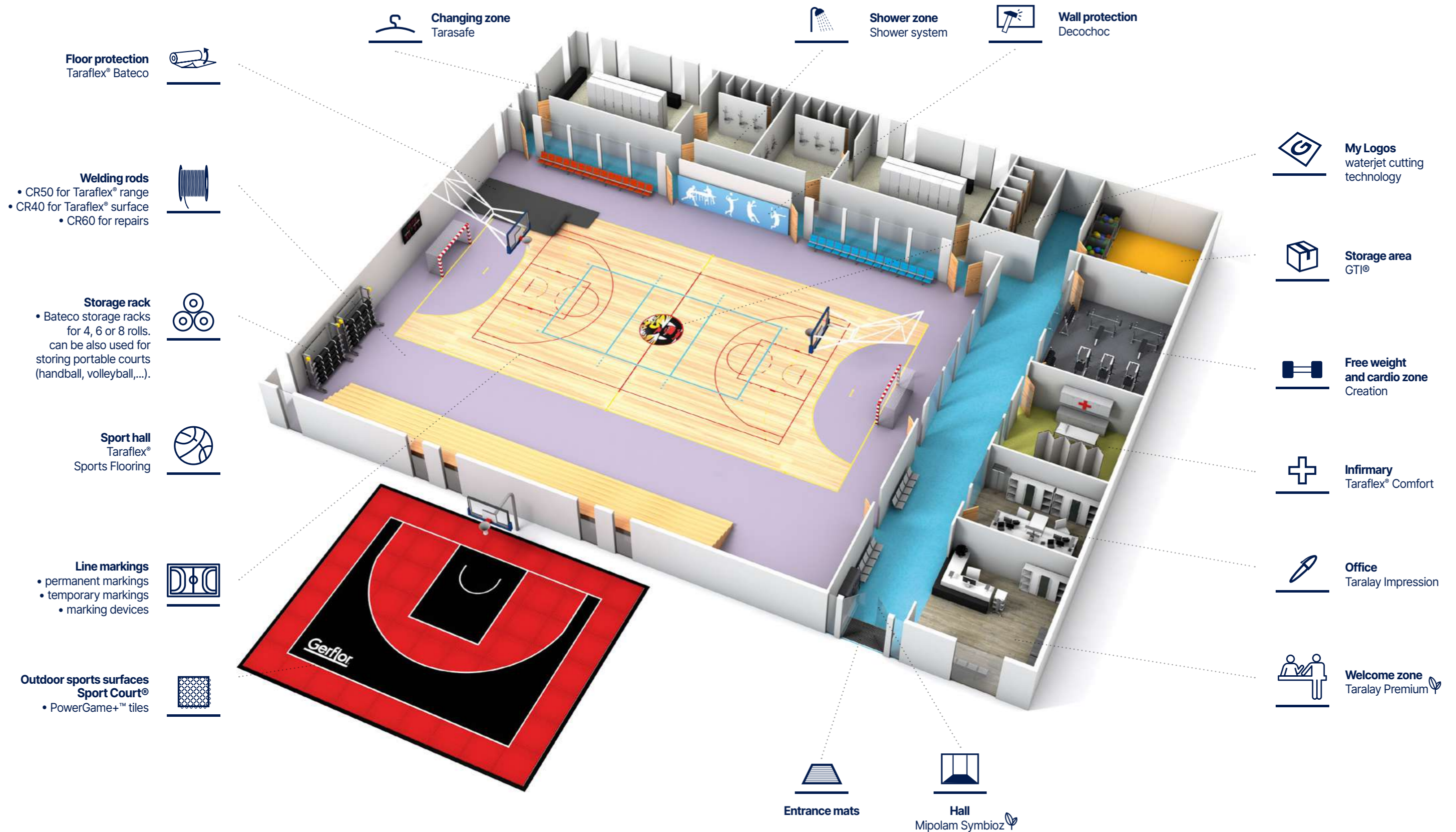

Connor Sports® Aspire I

Engineered wood Flooring Systems



Where Champions Play™

Top competitions take place on Connor Sports®

BASKETBALL

- ▶ 2020 Olympic Games (Tokyo)
- ▶ 2019 FIBA World Cup (China)
- ▶ 2016 Olympic Games (Rio)
- ▶ NCAA Final Four since 2006 (USA)



Champions deserve exceptional sport surface



So we select exceptional maple lumber for them

Connor Sports® hand selects north american maple trees grown north of the 35th parallel, where the shorter growing season produces a more dense and uniform woodgrain excellent for sports flooring.



Since its establishment in 1897, the Maple Flooring Manufacturers Association (MFMA) is the authoritative source of technical and general information about maple flooring and related sports flooring systems. Connor Sports® is a charter member of the MFMA and the 1st member of that group to be certified by the Rainforest Alliance.



Connor Sports® is proud to be the only ZeroWaste company in the sports flooring industry. Recycling, avoiding waste, developing innovative technology and a strong environmental consciousness are a major part of Connor Sports® corporate policy.



Connor Sports® works with FSC (Forest Stewardship Council®). This organization oversees high conservation value forest and protects the communities and indigenous people that rely on the forest. FSC ensures that everyone delivers the most environmentally friendly product.

Champions of sport

Hardwood systems for professional teams

More than half of the teams in the NBA have purchased a Connor Sports® hardwood system:



Boston Celtics



Brooklyn Nets



Philadelphia 76ers



Oklahoma City Thunder



Atlanta Hawks



Golden State Warriors



Sacramento Kings



Utah Jazz



Milwaukee Bucks

More information on gerflor.com

Connor Sports® Aspire I

Designed to perform

High-Performance Structure

With durability in mind, the **Connor Sports® Aspire I** was developed by listening to what the market needs. The top 14 mm thick engineered wood board is made with three strips of European Oak in the top layer, while the cross-layered construction of the board ensures a high level of dimensional stability. Thanks to its factory-applied varnish, it also offers easy maintenance and long-lasting appearance.

Sport Varnish

- Compatible with **EN 14904** Factory applied ensuring high resistance to abrasion, scratches.

Flooring (14mm)

- Solid oak wood **3.5mm** 3-strip wide engineered wood boards, with cross layer construction offering high level dimensional stability.



Premium pads (12mm)

- **12mm** Aspire pads Premium resilient pads provide exceptional cushioning under heavy impacts, enhancing player comfort and safety throughout the game.

Subfloor (24mm)

- Double plywood **2x12mm** Double plywood (2x12mm) structure offering a greater stability of the floor and increased resistance to static and rolling loads.

Key points

3.5mm
Solid Wood

>55%
Shock Absorption

10 YEARS
warranty

A4
category



Technical data

Wall base detail

- 1 3 Strips Oak engineered board (14mm)
- 2 Plywood panels 2 Layers (12mm)
- 3 Aspire resilient pads (12mm)
- 4 Vapour Barrier
- 5 Vented Cove Base (76mm x 1220mm)
- 6 Expansion Space

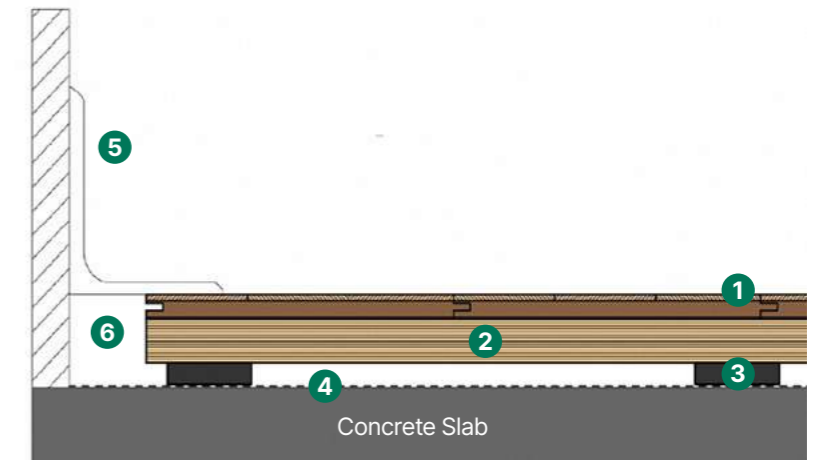

Product characteristics

Performance	Standard	Requirement	Unit	Results
Thickness	EN 428	-	mm	50
Shock absorption	EN 14808	≥ 25	%	≥ 55
Vertical deformation	EN 14809	≤ 5	mm	≤ 5
Sliding coefficient	EN 13036-4	80 to 110	-	80 to 110
Ball bounce	EN 12235	≥ 90	%	≥ 90
Abrasion resistance	EN ISO 5470-1	≤ 0.08	g	≤ 0.08
Impact resistance	EN 1517	≥ 8	N/m	PASS
Indentation resistance	EN 1516	≤ 0.5	mm	PASS
Fire	EN 13501-1	-	-	Cfl-s1

CE

Fire Shock Absorption Sliding Coefficient Resistance to rolling load Resistance to wear

Installation informations: find all details on our installation guidelines.

Sport Court® Outdoor Surfaces

Gerflor, Where Champions Play™

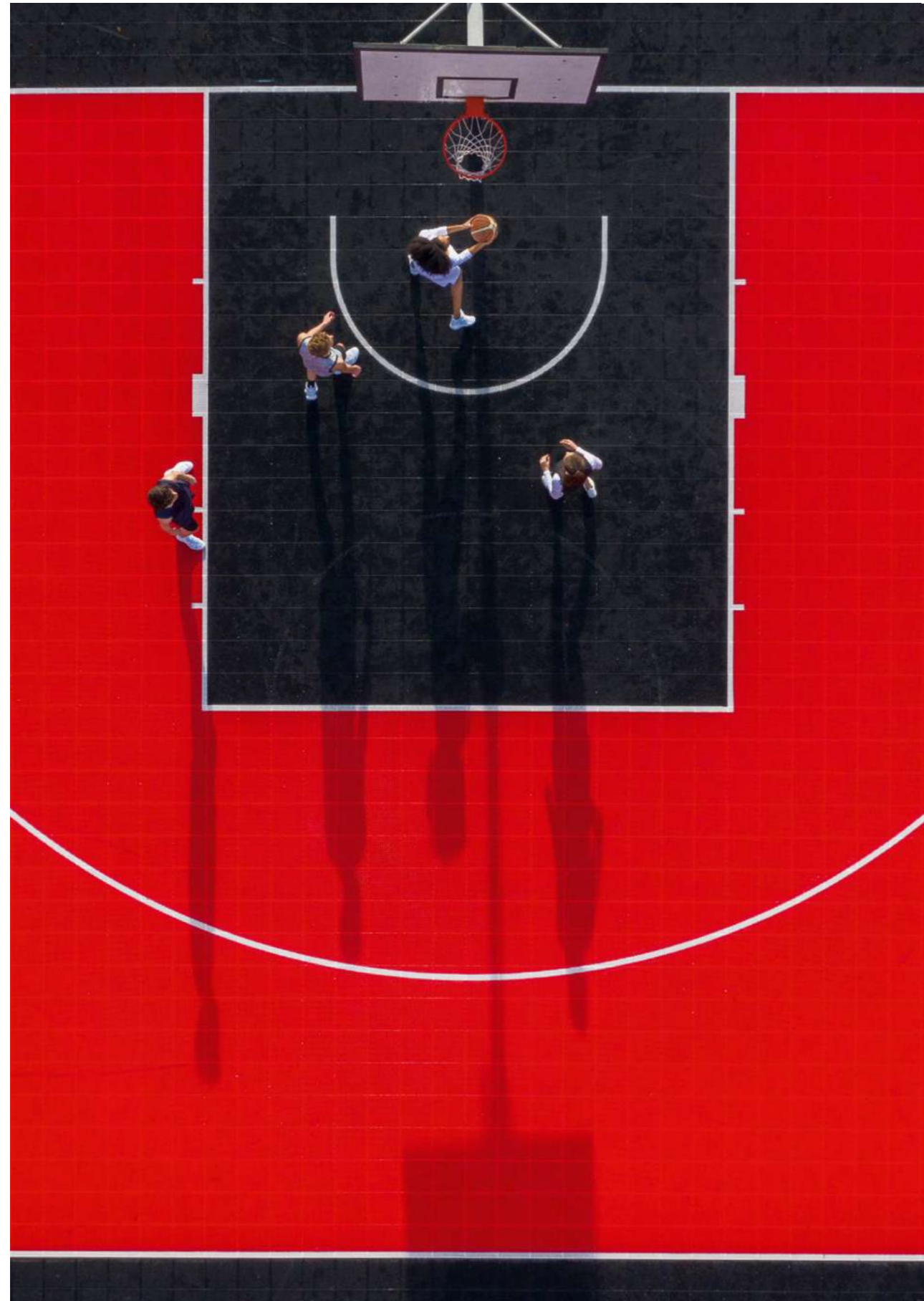

Sharing more than sport!

Bring people together for unforgettable moments and lifetime memories

With our modular PowerGame+ tiles, we offer everyone the opportunity to share such memorable sport and recreational experiences.

Our premium surfaces are not only fun, great-looking and safe to play on, but they can also be easily installed in all facilities. You can be sure you're providing the ideal playing outdoor surface for every practice and ambitions, from children to champions.

Designed for multi-sports

Sport Court® surfaces are designed for a wide variety of sports. All game courts can be easily configured to accommodate basketball, futsal, handball, tennis and more, without compromising on playability or safety.

A number of temporary or permanent applications are possible, from multi-sport school facilities to multi-use game areas to all kinds of sporting events.



Event-based courts



School facilities



Multi-Use Game Areas

Sport Court® Outdoor Surfaces

They trust us

Partner of sports federations

Sport Court® surfaces are used at the highest levels of competition by leading sports federations around the world. Our courts are perfect for both temporary events and permanent installations.

150 000
courts installed since 1974



Long-lasting aesthetics

Design a court that makes an impression. With a selection of 10 fade-resistant tile colours, you have more ways to customise the look of your playing surfaces to fit your requirements, whether you want a fun colourful court, or to customise it with your company's or school's colours.

Choose your colours

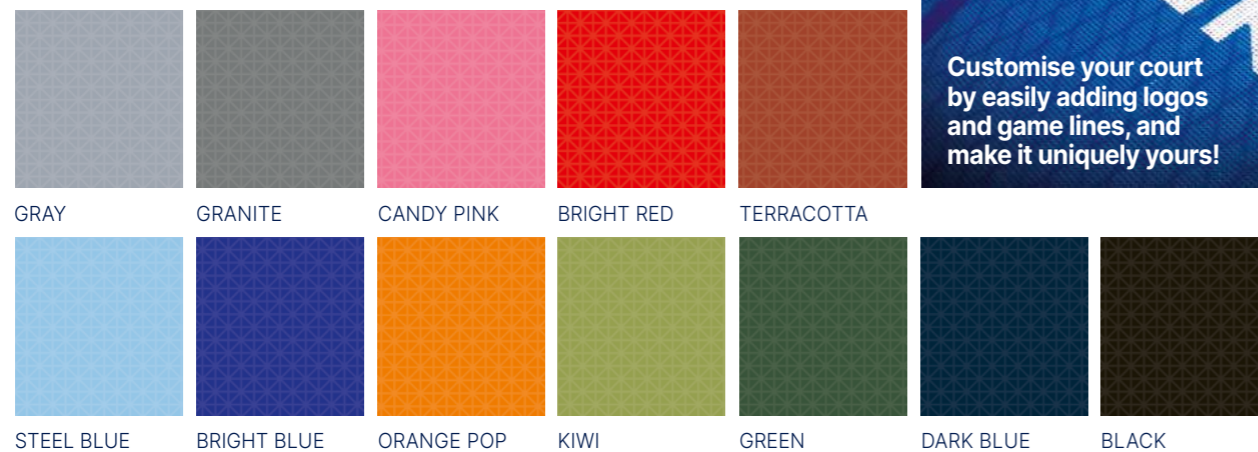

Customise your court by easily adding logos and game lines, and make it uniquely yours!

Optimal playability and safety

Powergame+ tiles provide exceptional protection against abrasion, head injuries and joint strain. Extensive third-party testing ensures that athletes of any age remain safe while playing and competing on Sport Court® surfaces.

Accomodate many sports with unmatched playability and safety



Powergame+ enhances game experience

- Highly versatile multisport surface
- Same dribbling response as a hardwood flooring
- Remarkably stable surface

Powergame+ provides a unique balance between safety, comfort and durability

- High tile stability optimises ball rebound and game performance
- Improved water drainage enables faster drying and playability after rain
- Low skin abrasion protects players when falling without compromising on traction

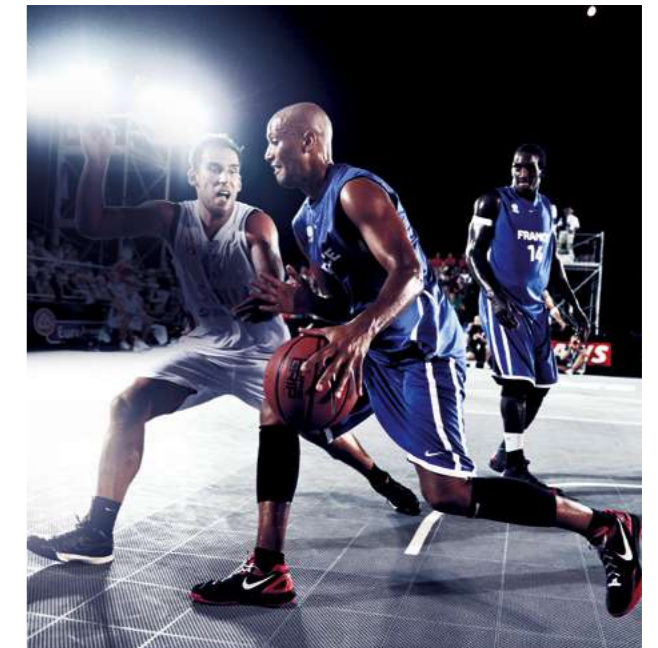

Superior Impact Protection

A head impact from just 10 cm above a concrete surface can cause a concussion. Sport Court® tiles are significantly more forgiving, with PowerGame+ reducing the likelihood of a serious head injury from a fall of 50 cm

Critical Fall Height is a test used in conjunction with the European Standards EN 1177-2018, used for evaluating playground surfaces, such as sand, wood chips, resilient rubber and asphalt.

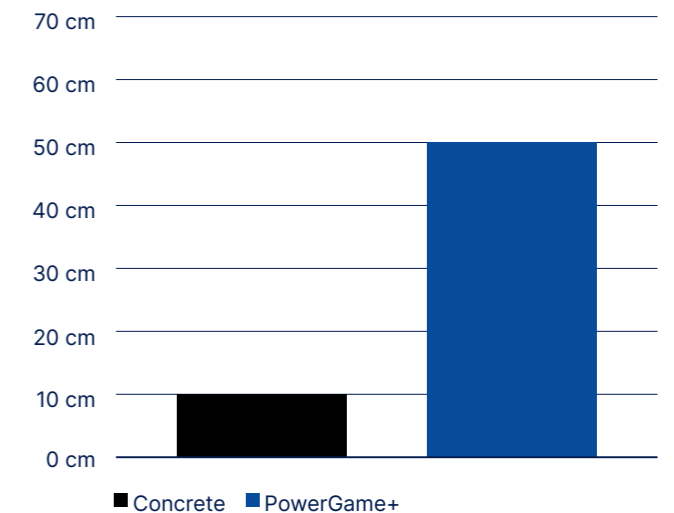

Sport Court® Outdoor Surfaces

Save time and money

Easy installation and maintenance

The simple and strong interlocking system enables the installation of a 1,000 sqm court in 4h



1,000M² COURT = 4H COURT INSTALLATION + 2H GAME LINE PAINTING

WITH A 4-PERSON TEAM



The next step in multi-sports outdoor surfacing

POWERGAME+

Made in France
Designed to provide the highest levels of safety and playability. PowerGame+ is the perfect choice for your facility.

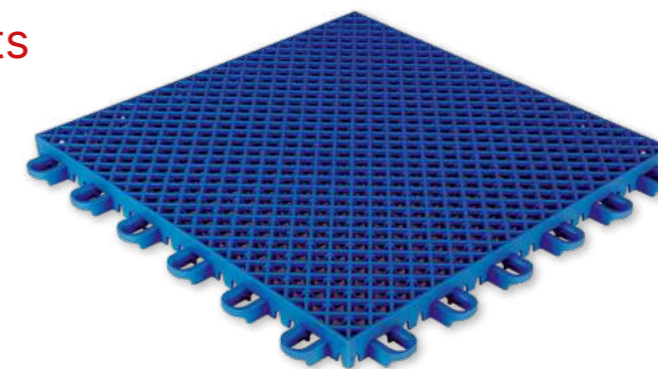

Long-lasting aesthetics

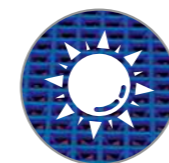

UV protection

Outstanding colour durability

Durabilité et confort de jeu



Wide and deep connection loops

High stability and durability over installation and removal, safety of the players

Optimal playability

Optimal grid design

Double-grid structure for faster drying, reduced water rebound, and optimal safety



Top-grid:

"Open Diamond" design
For better drainage



Lower grid:

"Saddle" Shape
To prevent water retention

A greater court with finishing profiles

Discover our complete range of finishing profiles, adapted to every court configuration.

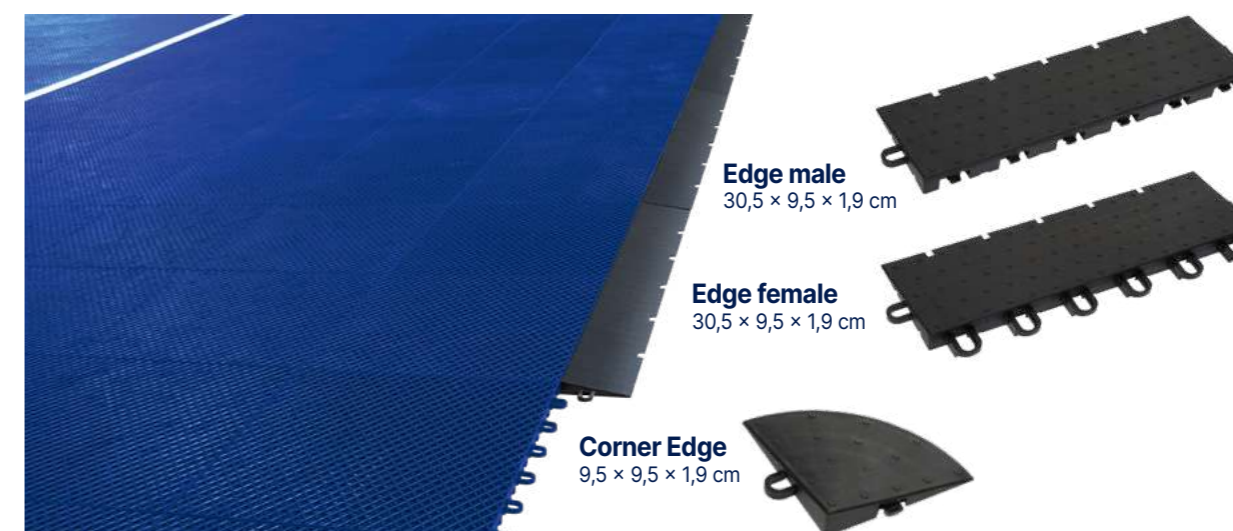

Edge male
30,5 × 9,5 × 1,9 cm

Edge female
30,5 × 9,5 × 1,9 cm

Corner Edge
9,5 × 9,5 × 1,9 cm

Polypropylene Profiles

- Easy and fast installation
- Beautiful additional elements to finish the court

Linoleum Sports Floorings

Colorette Sport / Linodur Sport / Marmorette Sport 3.2 mm



Colorette Sport

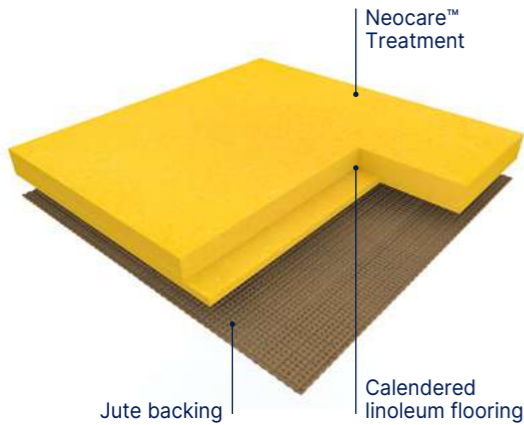

COLORETTE SPORT is a calendered linoleum compact floorcovering in sheet, 2 m wide, compatible with Gymflex II rubber underlay for a point elastic installation. Its weight is 4700 gr/sqm in 4.0 mm. It features a speckled design. It is composed of 98% natural materials (linseed oil, wood flour, resins, cork, minerals and jute fabric) among which 79% are rapidly renewable. The flooring is 100% recyclable. The flooring is produced with Neocare™ solvent-free surface treatment, an exclusive photo-cured acrylate based lacquer surface treatment obtained by triple laser UV cross linking. Neocare™ offers excellent scratch resistance as well as resistance to chemicals found in aggressive environments such as bleach, hydro alcoholic solutions, Betadine and Eosin as well as markers making maintenance easier and increasing the life of the flooring. This treatment avoids performing any polishing throughout the lifetime of the product. It can however be polished following usual recommendations and according to the customer's wishes. The flooring is 100% recyclable, 100% controlled, is REACH compliant and rated Cfl-s1 for fire resistance. The product also benefits from international certifications such as Floorscore® and Blue Angel (emissions). Designed and manufactured in a sustainable way in a plant awarded with ISO 9001 (quality), ISO 14001 (environment) and ISO 50001 (energy) certifications, the flooring is certified "Cradle to Cradle Silver".

Linodur Sport

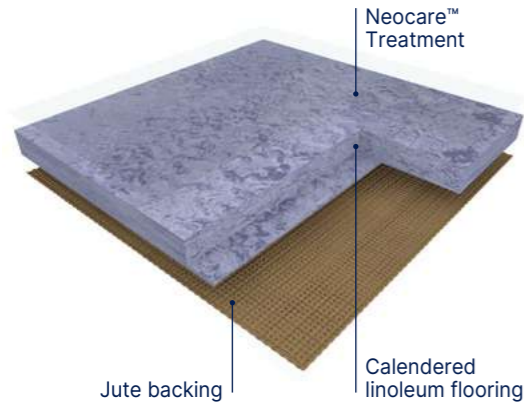

LINODUR SPORT is a calendered linoleum compact floorcovering in sheet, 2 m wide, compatible with Gymflex II rubber underlay for a point elastic installation. Its weight is 4700 gr/sqm in 4.0 mm. It features a modern design with a fine grain effect. It is composed of 98% natural materials (linseed oil, wood flour, resins, minerals coffee chaff and jute fabric) among which 83% are rapidly renewable. The flooring is 100% recyclable and contains up to 32% recycled content. The flooring is produced with Neocare™ solvent-free surface treatment, an exclusive photo-cured acrylate based lacquer surface treatment obtained by triple laser UV cross linking. Neocare™ offers excellent scratch resistance as well as resistance to chemicals found in aggressive environments such as bleach, hydro alcoholic solutions, Betadine and Eosin as well as markers making maintenance easier and increasing the life of the flooring. This treatment avoids performing any polishing throughout the lifetime of the product. It can however be polished following usual recommendations and according to the customer's wishes, 100% controlled, is REACH compliant and rated Cfl-s1 for fire resistance. The product also benefits from international certifications such as Floorscore® and Blue Angel (emissions). Designed and manufactured in a sustainable way in a plant awarded with ISO 9001 (quality), ISO 14001 (environment) and ISO 50001 (energy) certifications, the flooring is certified "Cradle to Cradle Silver".

Marmorette Sport 3.2 mm

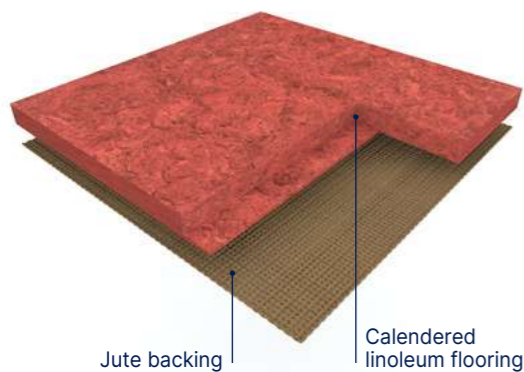

MARMORETTE SPORT 3.2 mm is a calendered linoleum compact floorcovering in sheet, 2 m wide. Its weight is 3800 gr/sqm in 3.2 mm. It features a marbled design. It is composed of 98% natural materials (linseed oil, wood flour, resins, minerals and jute fabric) among which 83% are rapidly renewable. The flooring is 100% recyclable, up to 40% recycled content, 100% controlled, is REACH compliant and rated Cfl-s1 for fire resistance. The product also benefits from international certifications such as Floorscore® and Blue Angel (emissions). Designed and manufactured in a sustainable way in a plant awarded with ISO 9001 (quality), ISO 14001 (environment) and ISO 50001 (energy) certifications, the flooring is certified "Cradle to Cradle Silver".

Colorette Sport / Linodur Sport / Marmorette Sport 3.2 mm



			Colorette Sport	Linodur Sport	Marmorette Sport 3.2 mm
Description					
Total thickness	EN ISO 24346	mm	4.0	4.0	3.2
Backing	-	-	Jute fabric	Jute fabric	Jute fabric
Weight	EN ISO 23997	g/sqm	4700	4700	3800
Width of sheet	EN ISO 24341	cm	200	200	200
Length of sheet	EN ISO 24341	m	Ca. 28	app. 28	app. 28
Material content	-	-	98% natural materials (bio-based & mineral), among which 79% are rapidly renewable, 100% recyclable	98% natural materials (bio-based & mineral), among which 83% are rapidly renewable, recycled content up to 32%, 100% recyclable	98% natural materials (bio-based and mineral) among which 83% are rapidly renewable, 100% recyclable, contains up to 40% recycled
Classification					
Norm / Product specification	-	-	EN 14904 / DIN V 18032-2 2001/04	DIN EN 14904 DIN V 18032-2	EN 14904 / DIN 18032-2
European classification	EN ISO 10874	class	23 / 34 / 43	23 / 34 / 43	23 / 34 / 43
Fire rating	EN 13501-1	class	Cfl-s1 ⁽¹⁾	Cfl-s1 ⁽¹⁾	Cfl-s1 ⁽¹⁾
Dynamic friction coefficient	DIN V 18032-2 2001/04	μ	0.4 - 0.6 OK	0.4 - 0.6 OK	0.4 - 0.6 μ - OK
Sliding Coefficient	EN 13036 - 4	-	80 - 110 OK	80 - 110 OK	80-110 - OK
Impact sound insulation	EN ISO 717-2	dB	8	8	6 dB
Performances					
Residual indentation	EN ISO 24343-1	mm	≤ 0.20	≤ 0.20 OK	≤ 0.15
Indentation resistance	EN 1516	mm	≤ 0.5 OK	≤ 0.5 OK	-
Slip resistance	EN 16165 App B (DIN 51130)	class	R10	R10	-
Colour fastness	EN ISO 105 - B02	degree	≥ 6	≥ 6	≥ 6
Point contact resistance	VDE 0100	-	-	-	p ≥ 0.20 OK
Light reflection	DIN 5036-3	-	ρ ≥ 0.20 OK (except colours 1004,1080 und 1118)	ρ ≥ 0.20 OK (except colours 1013,1024,1059,1073,1081)	-
Static electrical propensity	EN 1815	kV	≤ 2	≤ 2	app. 2.0
Castor chair test (Type W)	ISO 4918	-	OK	OK	OK
Thermal resistance	EN 12667	(m ² K)/W	0.023	0.023	0.018
Thermal conductivity	EN ISO 10456	W/(m.K)	0.17	0.17	0.17
Chemical products resistance	EN ISO 26987	class	Excellent ⁽²⁾	Excellent ⁽²⁾	OK
Impact resistance	EN1517	N/m	≥ 8 OK	≥ 8 OK	-
Abrasive wear resistance	EN ISO 5470-1	mg	≤ 1000 OK	≤ 1000 OK	-
Gloss level	EN ISO 2813	-	OK	OK	-
Surface Treatment	-	-	NEOCARE™	NEOCARE™	-
Anti-viral activity (Human coronavirus) after 5 h ⁽³⁾	ISO 21702	-	> 98.65 % virucidal activity	> 98.65 % virucidal activity	-
Anti-bacterial activity (E. coli - S. aureus - MRSA) ⁽³⁾	EN ISO 22196 (JIS Z 2801)	-	> 99.99% inhibits growth after 24h	> 99.99% inhibits growth after 24h	-
Indoor air quality (TVOC after 28 days)	EN 16516	μg/m ³	< 30	< 50	-
Circular Economy					
Certification	Cradle to Cradle	-	Silver	Silver	Silver
CE Marking					
CE	EN 14904: 2006	-			

(1) Glued according to certificate.

DOP numbers available from your local branch.

(2) Resistant to non-colouring alcohol-based sanitisers, domestic chemicals and acid and alkaline solutions for short periods.

(3) The implementation of an effective cleaning method is the best defence against infection.

⚠ Depending on light exposure, the product color can vary, due to linoleum natural oxidization process. This process is reversible. We recommend that the samples be exposed to sunlight for several hours prior to making a final color choice.

Linoleum Sports Floorings

Linodur Sport

Compact Neocare™ 4 mm



Colorette Sport

Compact Neocare™ 4 mm



Marmorette Sport 3.2 mm

Compact 3,2 mm



Linogym II - 10 mm

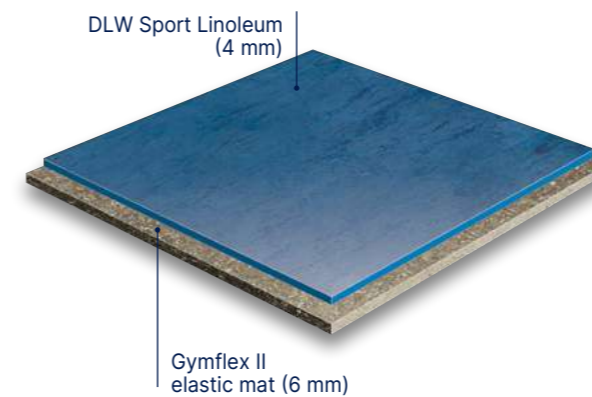

Ideally suited for kindergardens. With a 26% impact absorption rate, **LINOGYM II SYSTEM** provides outstanding cushioning qualities.

THE LINOGYM II SYSTEM – point-elastic flooring!

LINOGYM II SYSTEM brings together the best of Sport Linoleum and elastic matting. It consists of the 6 mm elastic matting Gymflex II on which a 4 mm Sports Linoleum (Linodur or Colorette) will be installed. With a 26% impact absorption rate, **LINOGYM II SYSTEM** provides outstanding cushioning qualities. The elastic matting is made of PUR and rubber.

Powershock Fitness Rubber Solutions



High impact rubber solutions for fitness

Powershock 80

Cardio & Free-weight zone

POWERSHOCK 80 is:

- ✓ Highly **durable**
- ✓ **Easy to clean and maintain**
- ✓ **Highly resistant** to static loads and to dumbbells thanks to the vulcanization process of this 8 mm vulcanized rubber

Vulcanized rubber is a chemical process through high pressure and temperature enables the sulfur atoms to form links and bridges between long chains of rubber molecules. This increases the overall strength and durability of the rubber.



Black



8 mm
Interlocking tiles with dovetail edges

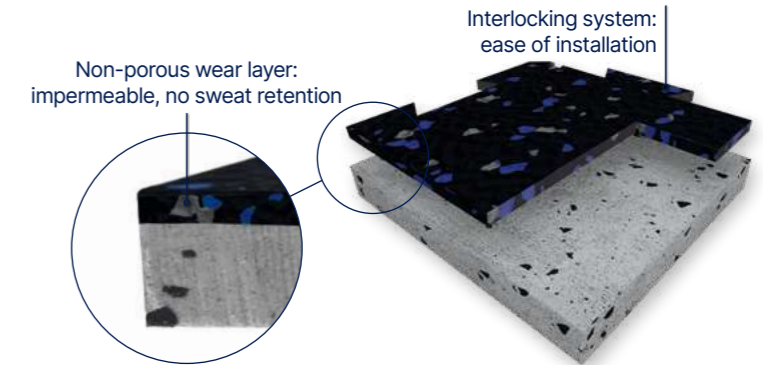

Non-porous wear layer:
impermeable, no sweat retention

Interlocking system:
ease of installation

Accessories

(available from Romus)



Aluminium reducer
Unit : 3 lm

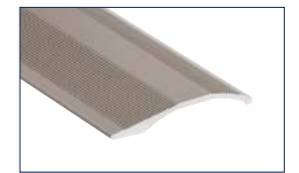

Multilevel coverstrip
Unit : 2,7 lm

Powershock 300

Crossfit & Heavy-weight area

POWERSHOCK 300

avoids deep-impact damage while providing an outstanding sound deadening, as well as:

- ✓ high **shock absorption**
- ✓ **Sound insulation** of 24 dB
- ✓ great **protection of the subfloor** being a 30 mm high impact rubber.

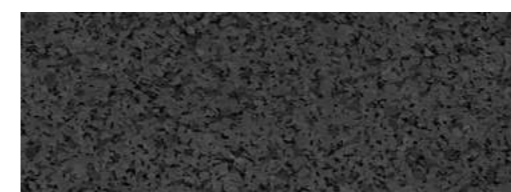

Dark Grey

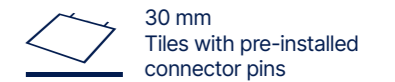

30 mm
Tiles with pre-installed connector pins

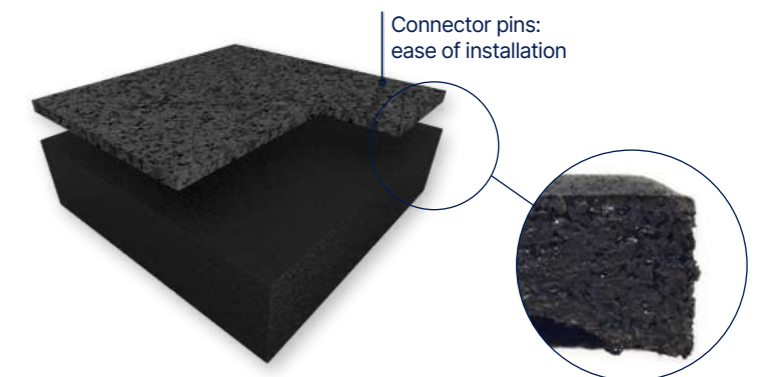

Connector pins:
ease of installation

Accessories

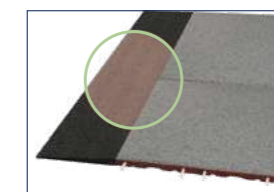

Ramp edge rubber 30 mm
1 lm



Corner ramp edge rubber
30 mm
2 units (1000 x 250 mm)

Powershock Fitness Rubber Solutions

Technical Data

Description	Powershock			
	300		80	
	Crossfit & heavy-weight area		Cardio & free-weight area	
Thickness	NF EN ISO 24346	mm	30 (± 2)	8
Weight	NF EN ISO 23997	kg/tile	6,8 (±0,2)	11,9
Size	NF EN ISO 24342	mm	500 × 500 (±0,8 %)	980 × 980 (incl. dovetails)
Classification				
Fire resistance	EN 13501-1	class	Cfl,s1	Bfl,s1
VOC	ISO 16000-6	class	A+	A+
Performance				
Dimensional stability	NF EN ISO 23999	%	< 0,1	< 0,3
Abrasion	EN ISO 5470-1	g	1,5	< 0,5
Light resistance	EN ISO 20105 - B02	level	3	4
Indentation resistance	EN 1516	mm	0,12	< 0,1
Slip resistance in dry condition	EN 13036-4	unit	80-110	80-110
Sound insulation	EN ISO 717/2	dB	24	13
Hardness shore A	Int.	-	60	> 75

Our solutions for your fitness center

Each zone in your club has different constraints and requirements; we have solutions for each one of them.

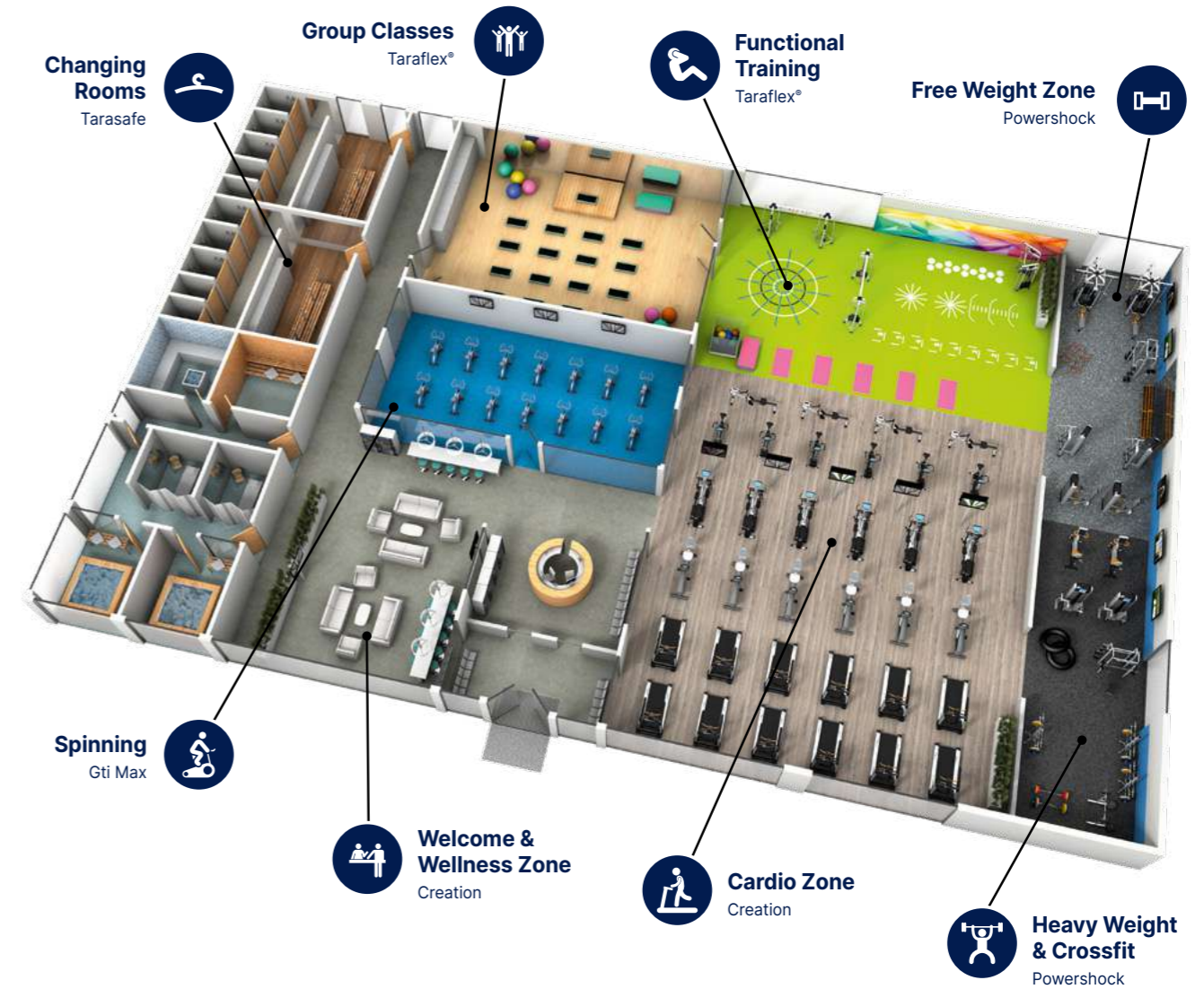

Welcome Zone



Functional Training



Spinning Zone



Cardio Zone



Group Classes



Weightlifting Zone



Finishes

pages 330-363

332. Finishes

350. Technical Solutions

358. Sports Finishes

Specifications

pages 364-371

Finishes

333. Skirting and coving solutions

338. Stair solutions

- 338. Stair nosing inserts
- 340. Tarastep Pro / Clip System

344. Profile solutions

347. Welding solutions

348. Entrance solutions



Finishes

Skirting and coving solutions

There are two ways of finishing the junction between the floor and wall:



PVC Cove former + Capping strip



Design skirting (MDF)



Design skirting (PVC)



Flexible full cove former



Semi-rigid skirting

Making a cove.
This solution makes it easier to clean inside angles and edges.
It gives a waterproof connection wall/floor covering.

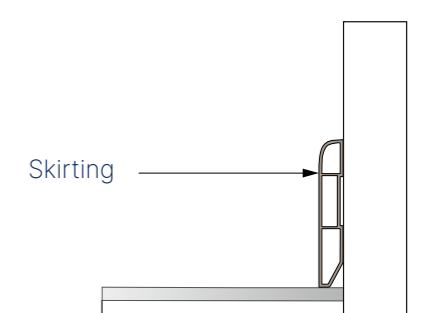
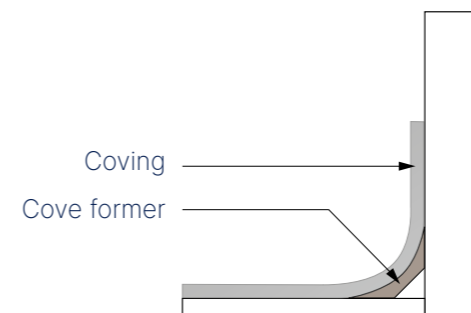

FOCUS











Gerflor provides a complete range of solutions including skirting, stairs, profiles and welds.

Finishes

Coving solutions

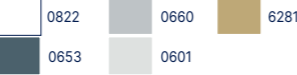
PVC CAPPING STRIPS

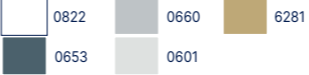
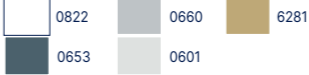

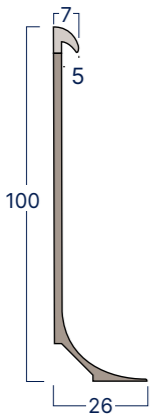
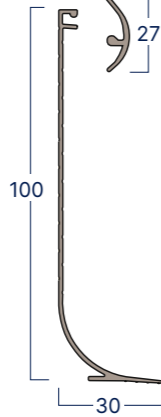
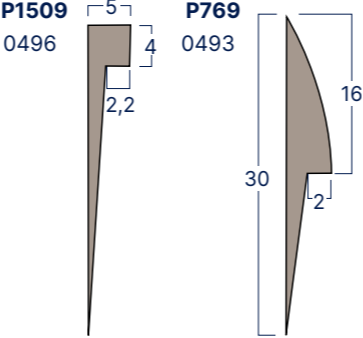
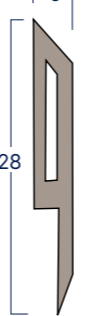
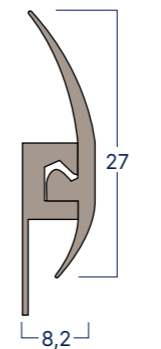
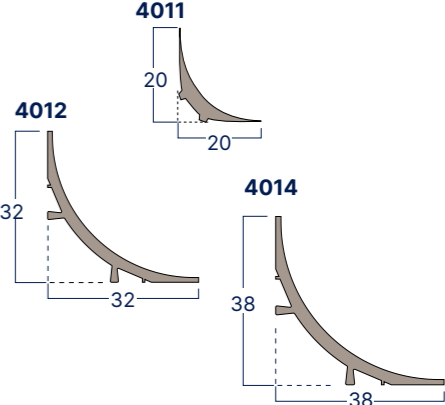

PVC CAPPING STRIPS

Description	 <p>0488</p> <p>FLEXIBLE FULL COVE FORMER PVC profile combining the cover former and the capping strip into a single product.) • Adapted to the hospital sector and any room requiring a waterproof skirting</p>	 <p>0487</p> <p>FULL COVE FORMER CLIP-SYSTEM PVC profile combining the cover former and the capping strip into a single product. • Adapted to the hospital sector and any room requiring a waterproof skirting.</p>	 <p>0496 0493</p> <p>P1509 / P769 Finishes that can be welded to the floor covering. • Do not use in commercial kitchens and showers</p>	 <p>0491</p> <p>CAPPING STRIPS Rigid capping strip with flexible lip • Do not use in commercial kitchens and showers</p>	 <p>0486</p> <p>CAPPING STRIP CLIP SYSTEM Rigid clipped finishing profile with 2 flexible lips • Capping strip that covers the skirting</p>	 <p>4011 - 4012 - 4014</p> <p>PVC COVE FORMER This accessory allows the floor-wall cove to be formed</p>
Colours						
Benefits	<ul style="list-style-type: none"> • Maximum floor covering thickness 4 mm • Guarantees watertightness • Quick to install  <p>Packaging 15 × 3 lm strips</p>	<ul style="list-style-type: none"> • Maximum floor covering thickness 4 mm • Guarantees watertightness • Quick & easy to install thanks to the capping strips with clip  <p>Packaging 20 × 3 lm strips</p>	<ul style="list-style-type: none"> • P769: Adapted to 2 mm floors • P1509: Adapted to 2.2 mm floors  <p>Packaging 30 × 3 lm strips</p> <p>Packaging 2 rolls of 25 lm</p>	<ul style="list-style-type: none"> • Maximum covering thickness: 4 mm • Hygienic • Easy to install  <p>Packaging 15 × 3 lm strips</p>	<ul style="list-style-type: none"> • Maximum floor covering thickness: 4 mm • Good watertightseal for finishing floor-wall coves and floor-wall systems notably in industrial kitchens • Easy to install thanks to the clip system  <p>Packaging 20 × 3 lm strips</p>	<ul style="list-style-type: none"> • Its rounded shape makes it easier to clean the floor-wall junction • Propose une meilleure esthétique • Gives a better look • Limits the risk of piercing the floor covering • Prevents accumulation of dirt and bacteria  <p>Packaging 30 × 2 lm strips</p>
Tips	<ul style="list-style-type: none"> • Heat the skirting with a heat gun in order to match the shape of the wall • Use either a double bonding adhesive, a dispersion contact adhesive or a double sided tape compatible with the PVC skirting 	<ul style="list-style-type: none"> • Heat the skirting with a heat gun in order to match the shape of the wall • Use either a double bonding adhesive, a dispersion contact adhesive or a double sided tape compatible with the PVC skirting 	<ul style="list-style-type: none"> • May also be used as a floor stopping profile • Weld with SG916 • Use either a double bonding adhesive, a dispersion contact adhesive or a two-side adhesive compatible with the PVC skirting 	<ul style="list-style-type: none"> • Slightly heat the strip if it whitens once installed • Use a miter shear for a perfect cut • Use either a double bonding adhesive, a dispersion contact adhesive or a double sided tape compatible with the PVC skirting 	<ul style="list-style-type: none"> • Heat the profile with a heat gun (temperature about 150°C) for the installation of the external corners • Use a miter shear for a perfect cut • Use SG916 for a perfect finish of the internal corners • Slightly heat the profile if it whitens once installed • Use either a double bonding adhesive, a dispersion contact adhesive or a double sided tape compatible with the PVC skirting 	<ul style="list-style-type: none"> • Use a mitre shear for a perfect cut

Colours and images are not contractual.

Finishes

Skirtings

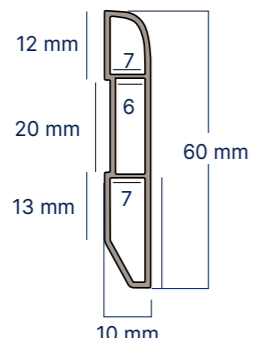
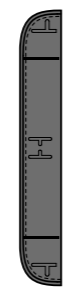
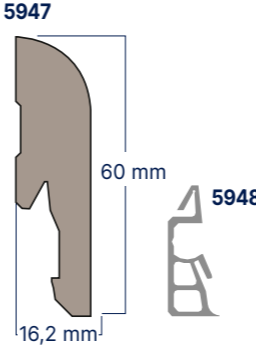
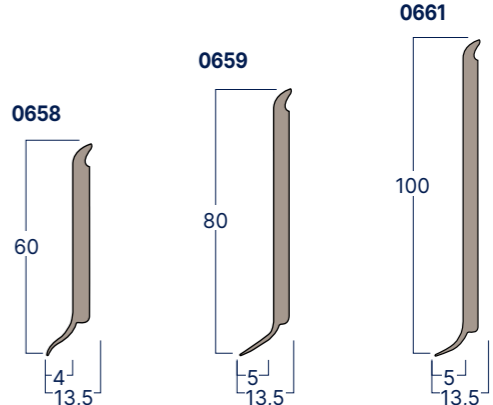
	DESIGN SKIRTING (PVC)	PVC DESIGN SKIRTING ENDCAP	DESIGN SKIRTING MDF	SEMI-RIGID SKIRTING
Description	 <p>SKIRTING (PVC) Vinyl Design Skirting for a perfect finish of Gerflor floorcoverings. 100% watertight, it could be installed in all environment.</p>	 <p>ENDCAP (PVC) These caps allow to cover PVC Design Skirting side.</p>	<div style="display: flex; justify-content: space-around;"> <div style="text-align: center;"> <p>GLUE DOWN</p>  </div> <div style="text-align: center;"> <p>INTERLOCKING</p>  </div> </div> <p>SKIRTING (MDF) MDF Design Skirting for a perfect finish of Gerflor floorcoverings.</p>	 <p>VYNAFLEX Semi-rigid PVC skirting to be placed on the wall</p>
Colours		<p>Anthracite grey 0001</p>	<div style="display: flex; flex-wrap: wrap; gap: 5px;"> <div style="width: 20px; height: 20px; background-color: white; border: 1px solid black; margin-right: 5px;"></div> Blanc 0822 <div style="width: 20px; height: 20px; background-color: black; border: 1px solid black; margin-right: 5px; margin-top: 5px;"></div> Noir 6512 <div style="width: 20px; height: 20px; background-color: grey; border: 1px solid black; margin-right: 5px; margin-top: 5px;"></div> Gris 0430 <div style="width: 20px; height: 20px; background-color: #c08040; border: 1px solid black; margin-right: 5px; margin-left: 20px;"></div> Miel 0455 <div style="width: 20px; height: 20px; background-color: #804040; border: 1px solid black; margin-right: 5px; margin-left: 20px; margin-top: 5px;"></div> Taupe 0456 </div>	
Benefits	<ul style="list-style-type: none"> Thin and discrete, it ensures an elegant finish and hides the dilatation gaps Available in all designs in Creation 30/40/55/70 Core Collection The skirting is also available in a paintable white version 	<ul style="list-style-type: none"> PVC cap, aluminum color, fits all our PVC Design Skirtings Can be used for one side of the skirting or the other 	<ul style="list-style-type: none"> Available in all designs in Creation 30/40/55/70 Core Collection It ensures an elegant finish and hides the dilatation gaps The skirting is also available in a paintable white version 	<ul style="list-style-type: none"> Solid colour Resistant to washing waters
Packaging	 <p>Packaging 6 × 2 m</p>	 <p>Packaging Bag of 10 reversible caps</p>	 <p>Packaging 5947: 5 × 2.2 m 5948: 1 box of 30 clips</p>	 <p>Packaging 0658 / 0661: 25 format (3lm) 0659: 32 format (3lm)</p>
Tips	<ul style="list-style-type: none"> Use a wood saw with fine teeth Use a mitre box for the corner Do not screw or nail 	<ul style="list-style-type: none"> Cut one end, glue it, press it 	<ul style="list-style-type: none"> Use a wood saw with fine teeth Use a mitre box for the corner For more information contact the customer service 	<ul style="list-style-type: none"> Use skirting corner Cutter to handle internal and external angles Use either a double bonding adhesive, a dispersion contact adhesive or a double sided tape compatible with the PVC skirting Apply an adhesion primer if the sub-floor is porous

Colours and images are not contractual.
For more information contact the customer service.

Finishes

Stair solutions

Gerflor has developed 2 solutions for installing a Vinyl floor on stairs to complement its range of floors:

1 Stair nosing insert

- Install the vinyl flooring and the stair nosing by starting at the bottom of the stair
- Install the riser
- Install the stair nosing
- Install the flat of the stair
- Weld

Adapted to straight stair nosing, rounded stair nosing and bird's beak stair nosing.

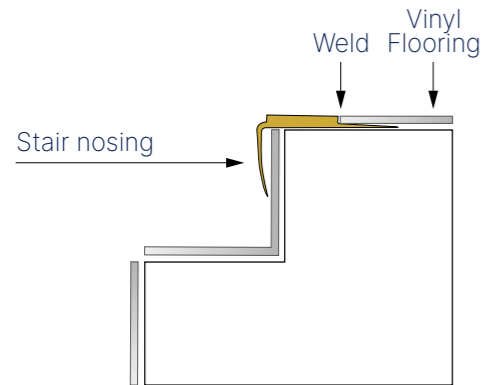

2 Tarastep Pro

- Install the base of the finishing clip onto the flat angle of the stair
- Install the Tarastep
- Clip the stair clip system

Adapted to rounded stair nosing.

Mill the angle for straight stair nosing.

For bird's beak stair nosing, fill the void beforehand.

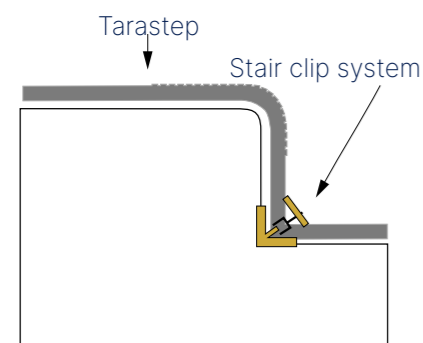

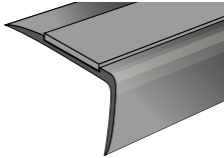
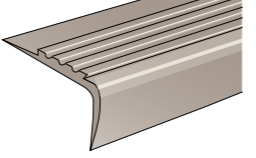
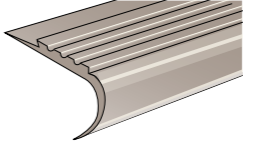
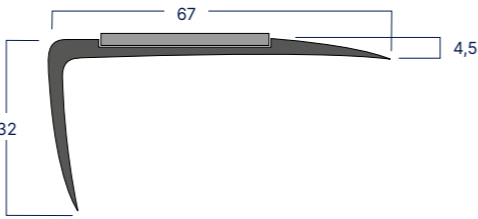
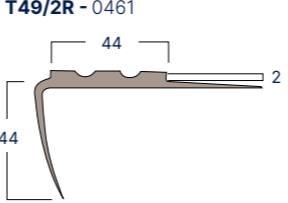
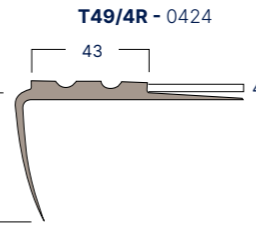
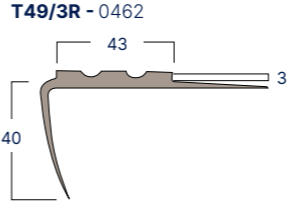
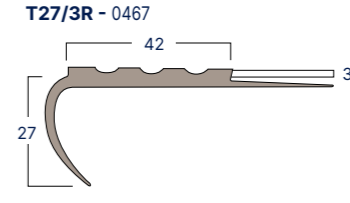
	STAIR NOSING INSERT		STAIR NOSING INSERT	
Description	 <p>ALUMINIUM STAIR NOSING</p> <ul style="list-style-type: none"> • Landing/stair harmony • Guarantees floor covering durability 	 <p>GROOVED PVC STAIR NOSING</p> <p>T49/4R - T49/3R - T49/2R Straight angles</p>	 <p>GROOVED PVC STAIR NOSING</p> <p>T27/3R Rounded angles and bird's beak</p>	
	<p>0664</p>	<p>0424 - 0462 - 0461</p>	<p>0467</p>	<ul style="list-style-type: none"> • Grooves provide anti-slip protection • Landing/Stair harmony • Ensures floor covering durability
Colours	<p>0001</p>	<p>Gris 4203 Noir 6512</p> <p>Beige 6281</p>	<p>Gris 4203 Noir 6512</p> <p>Beige 6281</p>	
Benefits	<ul style="list-style-type: none"> • For a state-of-the-art stair finish • Delivered with a black strip made out of carborandum for an improved anti-sliping action of the stair nosing 	<p>T49/4R - T49/3R - T49/2R</p> <ul style="list-style-type: none"> • Adapted to 2, 3 or 4 mm floor covering • Weldable 	<p>T27/3R</p> <ul style="list-style-type: none"> • Adapted to 3 mm floor covering • Weldable 	
		  		
	<p>Packaging 5 × 3 lm strips + 5 carborandum strips</p>	<p>Packaging 10 × 3 lm strips</p>	<p>Packaging 10 × 3 lm strips</p>	
Tips	<ul style="list-style-type: none"> • Secure with flat head cross head countersunk stainless steel screws (not included) 		<ul style="list-style-type: none"> • Do not apply adhesive to the vertical part of the stair nosing • Double bonding 	

Colours and images are not contractual.

Finishes

Stair solutions / Tarastep Pro

Tarastep Pro

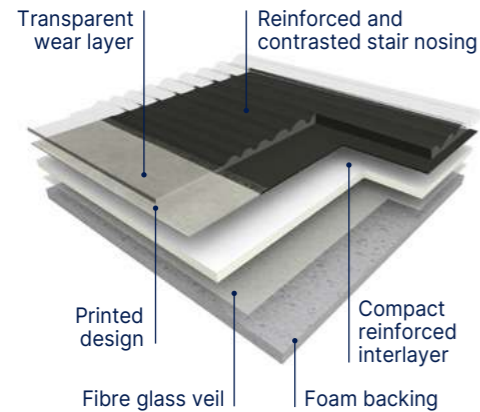

TARASTEP PRO is an **heterogenous, sound-absorbing** solution with reinforced layer and transparent wearlayer, used to **recover indoor stairs in a single element**. **TARASTEP PRO is an all-in-one** covering that covers the tread, the stair nosing - with a reinforced non-slip surface, and the riser. It has a total thickness of 3.45 mm, with a **wear layer of 1 mm** which gives it great resistance to traffic and a residual indentation of 0.10 mm (value measured). With a high-density foam backing, TARASTEP PRO provides 17dB of sound insulation and 63dB of walking noise. **It complies with accessibility regulations**. The stair nosing specially designed to facilitate movement presents a **tactile contrast and a visual contrast** of at least 70% on each color. **TARASTEP PRO** is suitable for premises classified **34/42 European class**. According to standard NF EN 13501-1, the coating is classified Bfls1. It is phthalate-free and complies with the European REACH regulation. TVOC air emissions at 28 days (NF EN 16000) of the selected coating are < 100 µg / m³. It is 100% recyclable.

Access for all (More details - See page 351)

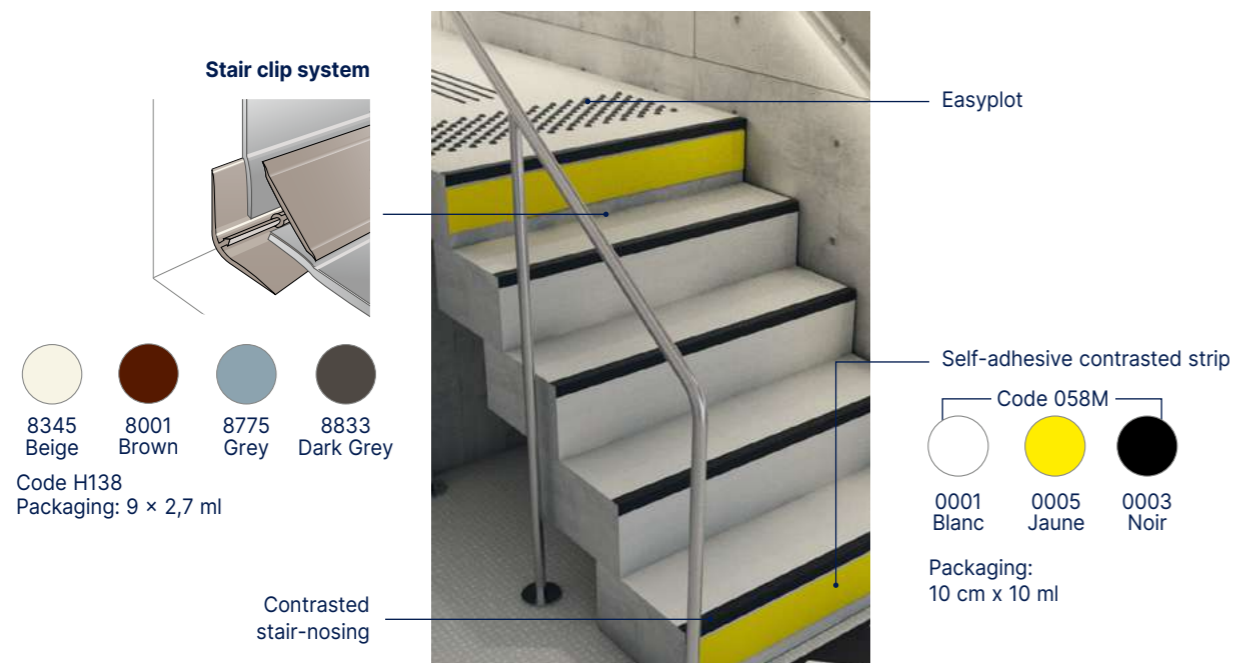

- **Complete solution for stairs:** more durable
- **Concrete design with 70% minimum contrast** with stair nose
- **Mix & match with Taralay and Premium ranges:** colors harmony stair & floor
- **High thickness:** comfort underfoot
- **1 mm wearlayer:** high resistance to traffic

Tarastep Pro

Description			
Total thickness	EN ISO 24346	mm	3.45
Thickness of wearlayer	EN ISO 24340	mm	1
Weight	EN ISO 23997	g/sqm	3005
Width of sheet	EN ISO 24341	cm	100
Length of sheet	EN ISO 24341	lm	20
Phthalate free	-	-	OK
Classification			
Norm / Product specification	-	-	EN ISO 11638
European classification	EN ISO 10874	class	34-42
Impact sound insulation	EN ISO 717-2	dB	17
Walking sound	NFS 31 074	dB	< 65
Fire rating	EN 13501-1	class	Bfl-s1
Static electrical propensity	EN 1815	kV	< 2
Slip Resistance Wet	EN 16165:2021 – Appendix B (DIN 51 130)	classe	R10
Performances			
Wear resistance	EN 660.2	mm ³	≤ 2.0
Wear group	-	group	T
Dimensional stability	EN ISO 23999	%	≤ 0.40
Residual indentation (requirement)	EN ISO 24343-1	mm	≤ 0.20
Residual indentation (average measured value)	-	-	≈ 0.10
Thermal conductivity	EN ISO 10456	W/(m.k)	0.25
Colour fastness	EN ISO 105-B02	degree	≥ 6
Surface Treatment	-	-	Protecsol®
Chemical products resistance ⁽¹⁾	EN ISO 26987	-	OK
Environment			
Recyclability	-	%	100
EPD	-	-	Available
Health			
TVOC after 28 days	ISO 16000-6	microgram/m ³	< 100
Certification	-	-	Floorscore®
Anti-bacterial activity (E. coli - S. aureus - MRSA) ⁽²⁾	ISO 22196	-	> 99% inhibits growth
Anti-viral activity (human coronavirus) after 2h ⁽²⁾	ISO 21702	-	> 99.3% virucidal activity
CE marking			
CE		EN 14041	

(1) Regarding the resistance to chemicals, please download the corresponding leaflet from our website.
 (2) The implementation of an effective cleaning regime is the most important defence against infection.

Finishes

Stair solutions / Tarastep Pro

Acoustic 17 dB  100% recyclable

CUTTING SERVICE AVAILABLE

CUTTING SERVICE AVAILABLE



2338 Sand & Brown
82% contrast

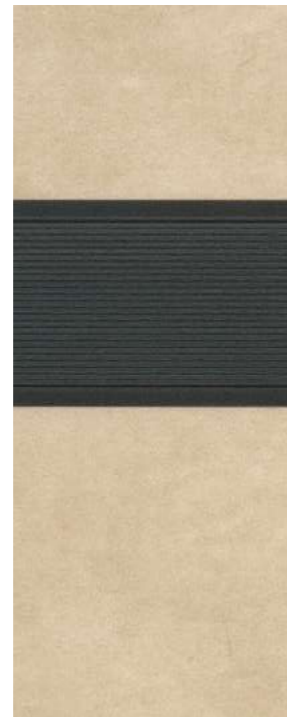

2333 Nature & Dark Grey
83% contrast



2335 Capri & Black
79% contrast



2342 Genova & Dark Grey
90% contrast



2336 Brescia & Black
84% contrast



2343 Light Grey & Black
85% contrast



2341 Black & Light Grey
77% contrast



2332 Silver & Dark Grey
86% contrast



2339 Dark Grey & Yellow
73% contrast



2334 Blue Grey & Clear
73% contrast



2337 Deep Blue & Clear
77% contrast

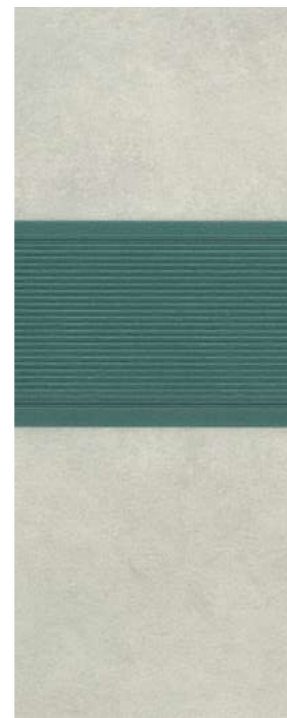

2344 Silver & Green
73% contrast



2340 Warm Grey & Black
77% contrast

Finishes

Profile solutions

Our profiles provide solutions to several problems concerning links between floors, walls or bare spots depending on the flooring thickness and technical requirements.



Diminishing profile



Connection profile



Design coverstrip



Ramp edges



Aluminium profiles

They in particular, allow two types of connections to be dealt with:

1 Connecting profiles

The connections between two floor coverings

- Floor/Floor
- Floor/wall

Allow the link between two floor coverings with different thicknesses.

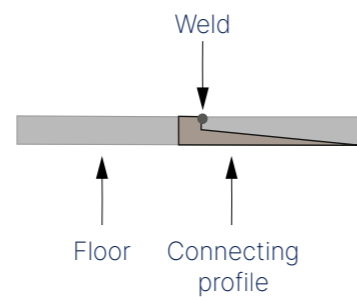

2 Ramp edges

The vinyl floor/bare spot connections

Protect the edging and prevent the floor covering from delaminating.

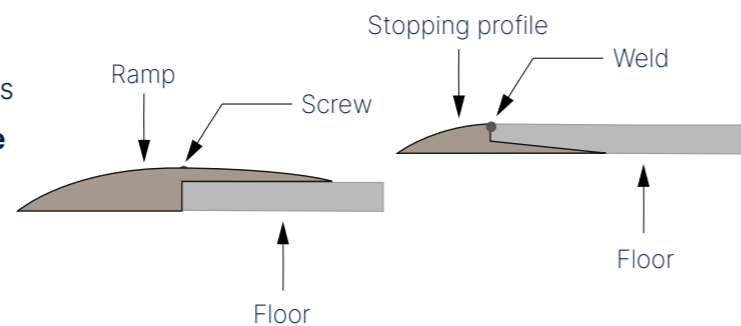

PVC profiles











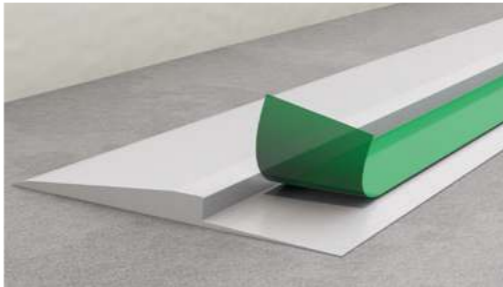

	FLOOR TO WALL CONNECTING PROFILE	FLOOR TO FLOOR CONNECTING PROFILE	DESIGN COVERSTRIP
Description	 <p>0490</p> <p>DIMINISHING PROFILE</p> <ul style="list-style-type: none"> • Coving/wall covering connection • Used in laboratories, hospital shower systems, commercial kitchens 	 <p>0496</p> <p>P1509</p> <ul style="list-style-type: none"> • These products allow the link between two-floor coverings to be made 	 <p>0642 + Color code</p> <ul style="list-style-type: none"> • Aluminium coverstrip with digital printed foil matching with some Gerflor LVT ranges
Colours	 <p>Noir 6512</p>	 <p>Noir 6512 Gris 4203</p>	<p>17 designs matching with Creation and Virtuo ranges + 1 Alu color.</p>
Benefits	<ul style="list-style-type: none"> • Makes it easier to link the floor covering and wall • Hygienic. Avoids bacteria accumulation • Prevents the floor covering from tearing, improves durability and ensures watertightness 	<ul style="list-style-type: none"> • Junction between two floors of 2.2 mm and 5 mm • Floor covering can be welded to profile to create a watertight seal • Can also be used as a finishing profile 	<ul style="list-style-type: none"> • 1 profile, 4 usages  <p>1. Expansion gap</p>  <p>2. Ramp</p>  <p>3. Threshold</p>  <p>4. Junction</p>
Tips	<p>Packaging 2 rolls of 25 lm</p> <ul style="list-style-type: none"> • Bonding with acrylic adhesive 	<p>Packaging 30 × 3 lm strips</p> <ul style="list-style-type: none"> • Polychloroprene double bonding 	<p>Packaging 4 units / box - 37 mm x 930 mn</p>

Colours and images are not contractual.

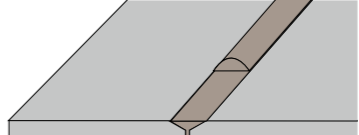
Finishes

Ramp Edges

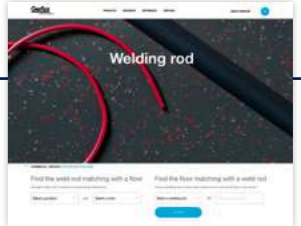
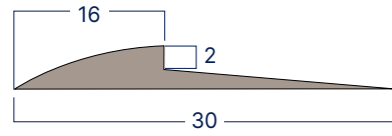
Ramp Edges/ Welding solutions

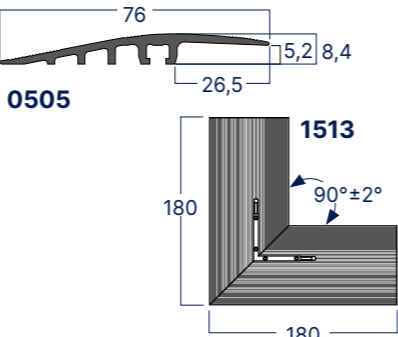
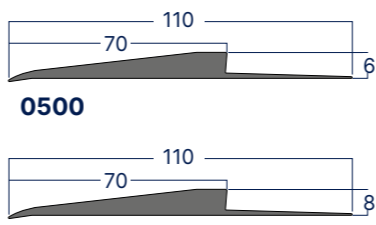
	RAMP EDGES	SCREWED	LOOSELAY	HOT WELD	
Description	 <p>P769</p> <ul style="list-style-type: none"> Connect other surfaces and vinyl floors <p>0493</p>	 <p>ALUMINIUM RAMP 2.8 MM</p> <ul style="list-style-type: none"> Access ramps resistant to high traffic and humidity <p>0504</p>	 <p>ALUMINIUM RAMP 5-6 MM</p> <p>0505</p>  <p>ALUMINIUM CORNER 5-6 MM</p> <p>1513</p>	 <p>PVC RAMP 6 MM</p> <p>0500</p>  <p>PVC RAMP 8 MM New</p> <p>7032</p>	 <p>WELDING RODS</p> <ul style="list-style-type: none"> This is used for all types of PVC floors, for coving sport floors Ensures a complete watertight seal <p>Gerflor has a large range of rods available</p> <p>Ø 4 mm / Ø 4.1 mm / Ø 5 mm / Ø 6 mm</p>  <p>The welding rod is placed in the chamfer between two floor coverings. When heated, it melts and fills the entire space to ensure complete watertight seal.</p>
Colours	 <p>Noir 6512 Gris 4203</p>	 <p>0001</p>	 <p>0001 0002</p>	 <p>0001</p>	<p>WELDING ROD AND FLOORING MATCHING TOOL</p> <p>gerflor.com/servicesprofessionals/welding-rods-matching.html</p> 
Benefits	<ul style="list-style-type: none"> Floor covering welding system Suitable for 2 mm floors Ensures watertight seal Can also be used as a capping strip  <p>Packaging 2 rolls de 25 lm</p>	<p>Product suitable for floor coverings of:</p> <ul style="list-style-type: none"> 2-3 mm <p>(Creation 70, Creation 55, Creation 30, ...)</p>  <p>0504</p> <p>Packaging 10 × 3 lm ramps</p>	<ul style="list-style-type: none"> Smooth shape for more utilisation comfort Connectors for a perfect connection of 2 profiles Pre-assembled corners for an easier installation and a perfect finish <p>Products suitable for floor coverings of:</p> <ul style="list-style-type: none"> 5-6 mm (Attraction®, GTI® MAX, Creation 70 Clic, Creation 55 Solid Clic, Creation 30 Solid Clic, ...)  <p>0505</p> <p>1513</p> <p>Packaging 5 × 3 lm ramps (0505) / 4 corners (1513)</p>	<ul style="list-style-type: none"> Product suitable for floor coverings of 6/8 mm (GTI®) Easy to install & no floor damage: time saving Unbreakable & less scratches: fewer replacing costs Easy to cut  <p>0500</p> <p>7032</p> <p>Packaging 8 lengths x 2 lm / box</p>	<p>Product suitable for floor coverings of:</p> <ul style="list-style-type: none"> CR40: Floor/floor weld - Code 0585 CR50: Welding of sport floors - Code H209 <p>Specific weld rods</p> <ul style="list-style-type: none"> CR50: Weld, Tarasafe Plus, floor repairs on special order - Code H009 CA72: Triangular rod for commercial kitchen floor to base welding - Code H007 CR60: Welding of sport floors, repair on special order - Code H011 BBR40: 100% Bio-based plasticizer rod for Mipolam Symbioz MCR40: Multicolor rod for Mipolam Accord & Affinity - Code H058 ULR40: Plain color welding rods for Linoleum floorcoverings (Colorette, Uni Walton, Lino Art) - R897 MLR40: Marble color welding rods for Linoleum floorcorings (Marmorette, Linodur): invisible seals - R898 <p>Packaging CR40, BBR40, CR50, CA72: 100 lm. coil CR60: 60 lm. coil MCR40: 50 lm. coil</p> <p><i>Please contact us for further information on weld rods</i></p>
Tips	<ul style="list-style-type: none"> Double bonding 	<ul style="list-style-type: none"> Delivered with fixation kit Screwing of the ramp to the floor with flat cross head countersunk stainless steel screws (Aluminium ramp 5-6 mm and aluminium corner) 	<ul style="list-style-type: none"> Looselay installation without damaging the subfloor (looselay ramp) 	<ul style="list-style-type: none"> For a better weld the correct grooving should be performed. Use an adapted nozzle (Ultra Speed Nozzle). 	

Colours and images are not contractual.

Finishes

Entrance Solutions

Three cleaning zones to be covered at the entrance to a building

Each zone has a specific "cleaning" role:



Zone 1



Ribbed Rubber Insert

Romat
Frequent traffic (500 p/day) 

Romat GT
Heavy traffic (500 to 2,000 p/day) 

Reversible
Intensive traffic (> 2,000 p/day) 

Zone 2



Textile Insert

Romat
Frequent traffic (500 p/day) 

Romat GT
Heavy traffic (500 to 2,000 p/day) 

Rubber Grate Insert

Romat reverse
Intensive traffic (> 2,000 p/day) 

Zone 3



Dirt-Trapping Mat

Ronet
Frequent traffic (500 p/day) 

Roclean
Heavy traffic (> 500 p/day) 

Entrance Mats

- ▶ Eliminate dust, moisture and other residue from visitors' feet as efficiently as possible at the entrance of a building.
- ▶ Prevent premature soiling and wear of floor coverings.

LOOSELAY ROMAT GT - INSERT KIT



Ref. 1719 - 1.5 × 1 m

For pedestrian traffic only.

Entrance mat affording floors of buildings efficient and sustainable protection from pedestrian traffic by forming a barrier to outside dirt. Thanks to its loose-lay installation, the mat can be installed without damaging the surface. Adapted for an important pedestrian traffic (up to 2000 people per day).

This kit contains:

- ▶ 1 mat
- ▶ 4 frames composed of 4 lower and 4 upper profiles
- ▶ 4 external pre-assembled corners
- ▶ 60 5-7 screws
- ▶ 1 Installation guideline

KIT ESPLANADE 9000



Ref. 1700 - 1.5 × 1.5 m

Kit for the incrustation of an ESPLANADE 9000 mat in an area covered with Attraction®, GTI®, Creation 55 Solid Clic, Creation 70 Clic. The closed conception of the mat enable to scratch the underside of shoes and increase the durability of the floors. It resists to intense pedestrian traffic (up to 5000/day) and to mecanial traffic.

- ▶ Packaging: 2.5 sqm kit: 3 mats modules, 4 upper and 4 lower profiles, screws.

Technical Solutions

351. Accessibility

352. LVT Underlayers

354. Specific products

- 354. Isolating membranes
- 354. ESD copper strip
- 355. Clean Corner System

356. Adhesives and tapes



FOCUS

Gerflor offers a full range of technical solutions such as the shower system, copper strips, adhesives or tools in order to provide all the technical requirements on site.

Technical Solutions

Accessibility

WARNING SURFACES

ALERTILE, SELF-ADHESIVE OR WELDABLE TACTILE SLAB

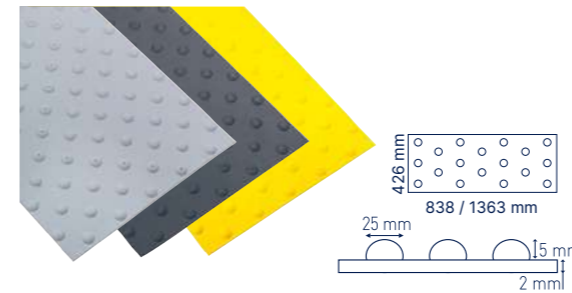

Dimensions: 426 x 1363 mm / 426 x 838 mm
 Packaging: 8 units per box (838 mm)
 4 units per box (1363 mm)
 Codes: 059B (838 mm) / 059A (1363 mm)

EASYPLOT, THE AESTHETIC SOLUTION FOR WARNING



Packaging: Kit of 198 studs (6 planks de 33 studs)
 approx. 1.3 m x 0.4 m
 Codes: 059C (Grey, Black) - 059D (Alu)

GUIDING

EASYGUIDE, THE SELF-ADHESIVE SOLUTION FOR GUIDING



Packaging: Box of 6 slabs 300 x 220 mm (4 bars/slab) for 1.8 m of guideline
 Code E219

SIGNAGE

Personalised cut-to-size system

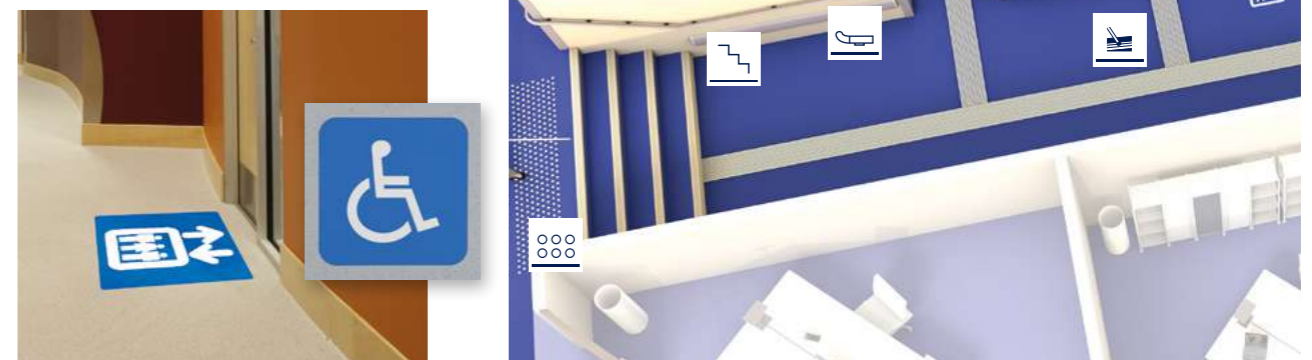

Technical Solutions

LVT Underlayers

	CREATION 40/55/70 CLIC	CREATION 40/55 CLIC	CREATION 40/55/70 CLIC	CREATION 30/40/55
Description	<p>GERFLOR ACOUSTIC 15 DB</p>  <p>1798</p> <ul style="list-style-type: none"> Sound absorption underlay in roll 	<p>GERFLOR SILENCE PLUS 19 DB</p>  <p>5949</p> <ul style="list-style-type: none"> Sound absorption underlay in accordion 	<p>GERFLOR ACOUSTIC PLUS 19 DB</p>  <p>0704</p> <ul style="list-style-type: none"> Sound absorption underlay in roll 	<p>GERFLOR SMART FIX 16 DB</p>  <p>1698</p> <ul style="list-style-type: none"> Underlay with self-adhesive surface Sound absorption underlay in roll
Benefits	<ul style="list-style-type: none"> Reduces impact noise up to 15 dB Adapted to the same traffic than the LVT but semi-industrial or industrial application Thickness: 0.93 mm <p>Packaging 1798 - 1 × 15 lm = 15 sqm</p>	<ul style="list-style-type: none"> Reduces impact noise up to 19 dB Adapted to the same traffic than the LVT but semi-industrial or industrial application Thickness: 1.5 mm <p>Packaging 5949 - 1.18 × 8.5 lm = 10 sqm</p>	<ul style="list-style-type: none"> Reduces impact noise up to 19 dB Adapted to the same traffic than the LVT but semi-industrial or industrial application Thickness: 1.2 mm <p>Packaging 704 - 0,98 × 15,3 lm = 15 sqm</p>	<ul style="list-style-type: none"> For a loose lay installation of LVT dry back. Reduces impact noise up to 16 dB Adapted to the same traffic than the LVT but semi-industrial or industrial application Thickness: 2 mm <p>Packaging 1 × 7.5 lm = 7.5 sqm</p>
Tips	<ul style="list-style-type: none"> Underlay is rolled on reverse Refer to technical installation guidelines to check the approved products 	<ul style="list-style-type: none"> Printed side on top Refer to technical installation guidelines to check the approved products 	<ul style="list-style-type: none"> Unroll the underlay Refer to technical installation guidelines to check the approved products 	<ul style="list-style-type: none"> Fleece side: on the subfloor Adhesived side: under the LVT Refer to technical installation guidelines to check the approved products

	ISOLATING MEMBRANES	ELECTRICAL CONDUCTIVITY	INTERNAL CORNER	EXTERNAL CORNER	TEMPLATES KIT			
Description	<p>ISOLSPORT</p>  <p>0829 0002 VINYL ISOLATING MEMBRANE Specially designed for sports For installation on concrete subfloors</p>	<p>TARAFOAM</p>  <p>997C 6792 COMFORT VERSION OF THE SHOWER SYSTEM</p>	<p>COPPER STRIP</p>  <p>0586 0001 ESD COPPER STRIP Copper strip enabling earthing</p>	 <p>058S PROFILE FOR INTERNAL CORNERS</p>	 <p>058R PROFILE FOR EXTERNAL CORNERS</p>	 <p>Internal corner</p>  <p>External corner</p> <p>058T Kit made of 2 templates for an easy and homogeneous installation of the internal and external corners</p>		
Benefits	<ul style="list-style-type: none"> Vinyl isolating membrane, double side on non woven glass fibre with backing design made up of 3-branch star foam pads. Its design enables loose laying on sensitive subfloors (risks of humidity, coated, etc.) when it is associated with a Taraflex® sporting floor. The raised effect allows humidity to circulate. Thickness: 1.7 mm 	<ul style="list-style-type: none"> Provides acoustic insulation for the shower system (15 dB) and comfort under foot. Thickness: 2 mm 	<ul style="list-style-type: none"> For electro-conductive floor coverings such as Elegance EL5, Technic EL5, GTI® EL5, Affinity EL7, Robust EL7 Width 10 mm, thickness 0.08 mm 	 <p>Watertight</p>	 <p>Resistant & Durable</p>	 <p>Clean</p>	 <p>Versatile</p>	 <p>Attractive</p>
Packaging	1 × 45 lm roll	Roll of 2 m x 20 lm - 40 m ²	1 × 200 lm roll	60 / box	20 / box	Unit		
Tips	<ul style="list-style-type: none"> Bond well at doors with PU adhesive to prevent delamination. Keep the raised surface, floor side, on the periphery Edge to edge installation 	<ul style="list-style-type: none"> Levels out around the edge of the room Acrylic bonding Edge to edge installation 	<ul style="list-style-type: none"> Prevent discontinuity between the angles by folding it back onto itself 					

Colours and images are not contractual.

Installation guidelines on gerflor.com

Technical Solutions

Adhesives and Tapes

Gerflor has developed specific bonding solutions to make it easier to install its products.

	ADHESIVES	hop HOLDING TAPE New	NON-MIGRATING DOUBLE SIDED TAPES	
Description	<p>GERPUR</p>  <p>086C 0083 Specially designed for sports Only for Dry Tex™ System (bonding of Taraflex sport floors with non-woven backing)</p>	<p>hop HOLDING TAPE</p>  <p>059E0001</p>	<p>FIX&FREE 100</p>  <p>058U 0001</p>	<p>FIX&FREE 740</p>  <p>058W 0001</p>
		Width: 96 mm	Width: 100 mm	Width: 740 mm
Benefits	<ul style="list-style-type: none"> • Bonding on new and old humid concrete subfloor • Mono component PU adhesive, reactive to humidity which enables the DTX material to be fully bonded in humid environment (no restriction of humidity levels with the exception of surface water) • Consumption: 400 to 450 g/m² <p>Packaging 15 kg bucket</p>	<ul style="list-style-type: none"> • Reinforced tape: durable • Easy to position • No transfer to surface underneath • Easy to remove without damaging the support • Makes welding easier <p>Packaging 1 × 50 lm roll</p>	<ul style="list-style-type: none"> • New double-sided tapes in order to install and uninstall our floorcovering easily, without damaging the subfloor. This is particularly useful for "ephemeral areas" (in retail for instance) or for renovation of subfloor containing asbestos. • Fix&Free 100 is suitable for textile backing floorcovering. • Fix&Free 740 is suitable for Creation Clic and GTI®. • Time saving and cleanliness by comparison with a bonded system. • No gumming time and no smell. <p>Packaging 1 × 50 lm roll</p>	<p>Packaging 1 × 25 lm roll</p>
Tips	<ul style="list-style-type: none"> • To be applied with ergonomic trowel for rigid adhesive and B1 blade 			

Colours and images are not contractual.

Sports Finishes

- 359. Marking
- 360. Specific Products
- 362. Adhesives and Tapes
- 363. Tools - Sport



FOCUS

We provide finishing solutions suitable for sports floor coverings such as permanent or temporary line marking solutions.

Sports Finishes

Marking



PERMANENT GAME LINES (PAINT)

Description	Article code	Components
KIT TLD AQUA BASKET	085V0001	4 red paint's can, 4 hardener's can, 9 adhesive tapes and 1 roller
KIT TLD AQUA BADMINTON	085W0001	3 black paint's can, 3 hardener's can, 7 adhesive tapes and 1 roller
KIT TLD AQUA TENNIS	085X0001	3 white paint's can, 3 hardener's can, 7 adhesive tapes and 1 roller
KIT TLD AQUA HANDBALL	085Y0001	4 yellow paint's can, 4 hardener's can, 9 adhesive tapes and 1 roller
KIT TLD AQUA VOLLEY	085Z0001	2 blue paint's can, 2 hardener's can, 3 adhesive tapes and 1 roller

TEMPORARY GAME LINES (TAPE)

Description	Article code	Use
3M TAPES BLACK (**)	HQ250002	For game lines
3M TAPES WHITE (**)	HQ250004(*)	For game lines - White = Tennis
3M TAPES RED (**)	HQ250005	For game lines - Red = Basket
3M TAPES BLUE (**)	HQ250006	For game lines - Blue = Volley



GAME LINE EQUIPMENT (PERMANENT & TEMPORARY)

Description	Article code	Use
GAME LINE MARKING DEVICE	087W0001	Circular line marking of up 9 m radius can be achieved with this device.

COMPONENTS

- 1 Marking head with 50 mm adhesive marking tape
 - 2 Marking head with 19 mm protective tape
 - 3 Extension poles
 - 4 Pole-connections
 - 5 Centre-part with 2 suction cups
 - 6 Sheet metal guides for straight lines
 - 7 Transporting case ABS
 - 8 Case for extension poles
- Circle cutter (optional for only 087X0001)

(*) White color can be used for any other monosport court.
 (**) To be installed on Taraflex® Range except on portable embossing.

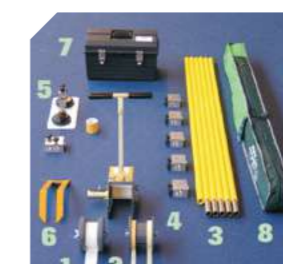

Game Line Marking Device





Circle Cutter

Sports Finishes

Specific Products / Isolating membrane & cleaning detergents

Specific Products / Cleaning detergents

	BATECO	SPORT FLOOR MAINTENANCE		PROTECSOL® FLOOR MAINTENANCE
Description	 <p>H3756801 (customized lengths) HM126801 (standard lengths at 20 lm) HM066801 (standard lengths at 30 lm)</p> <p>PROTECTIVE SURFACE</p> <p>Specially designed for sports Suitable for gymnasium / reception hall versatility</p>	 <p>089C0001 TRACIFLEX</p> <ul style="list-style-type: none"> • Multipurpose detergent for cleaning the vinyl sport floors (shoe marks and contact marks) • Also suitable for floors which are difficult to clean • For daily or weekly maintenance 	 <p>085E 0001 TANEX TROPHY</p> <ul style="list-style-type: none"> • Multipurpose detergent for cleaning the vinyl sport floors (shoe marks and contact marks) • Also suitable for floors which are difficult to clean • For weekly maintenance 	 <p>085A 0010 SPRAY TARACLEAN</p> <ul style="list-style-type: none"> • Spray cleaner to remove occasional and tough stains, notably resin marks
Benefits	<ul style="list-style-type: none"> • Protective surface made from black calendered and grained plasticised vinyl. • Taraflex Bateco is especially designed to protect sport floors in the event of non-sports use of the room. It prevents marking by chairs, tables, heels on the sport floor. • Thickness: 1.5 mm <p>Packaging 1 roll (12 to 45 lm)</p>	<ul style="list-style-type: none"> • Removes resin from Handball courts • Recommended in sport room  <p>Packaging 5 L can</p>	<ul style="list-style-type: none"> • For all sport floors <p>Packaging 2 cans of 5 L, for a total of 10 L</p>	<ul style="list-style-type: none"> • Suited to all types of floors treated with Protecsof® • Easy and quick to use <p>Packaging unit</p>
Tips	<ul style="list-style-type: none"> • Edge to edge installation • Strips can be secured with single-sided adhesive tape AT7 	<ul style="list-style-type: none"> • Traciflex may be sprayed on stubborn stains 		

Colours and images are not contractual.

DOUBLE SIDED TAPES FOR SPORT FLOORS

Description	AT7	TARAFIX SL
<p>ADHESIVE TAPE FOR SMOOTH SURFACES</p>  <p>H1050001</p> <p>DOUBLE-SIDE TAPE FOR SMOOTH SURFACES LIKE VARNISHED PARQUET OR PVC SPORTS FLOORS</p>	 <p>H206 0001</p> <p>SINGLE-SIDE TAPE</p>	 <p>06480001</p> <p>HOLDING STRIPS FOR TARAFLEX® SL SOLUTIONS</p>
Width: 96 mm	Width: 100 mm	Width: 96 mm
<p>Benefits</p> <ul style="list-style-type: none"> Adapted to temporary installation Requires a test on site for validation 	<ul style="list-style-type: none"> Black Bonds without leaving marks, non migrating <ol style="list-style-type: none"> Holds strips during non sportive events Enables the material to be secured on the tube at the time of winding Holds strips during the storage time 	<ul style="list-style-type: none"> Reinforced tape: durable Easy to position No transfer to surface underneath Easy to remove without damaging the support Makes welding easier
<p>Packaging</p> <p>0.096 × 45 lm roll (96 mm x 45 m)</p>	<p>Packaging</p> <p>0.1 × 33 lm roll (100 mm x 33 m)</p>	<p>Packaging</p> <p>0.096 × 25 lm roll</p>
<p>Tips</p> <p>Required material:</p> <ul style="list-style-type: none"> Double side tape reel Unroller for double sided tapes H372001 	<p>Required material:</p> <ul style="list-style-type: none"> AT7 tape reel Unroller for single sided tapes H367 0003 	<p>Required material:</p> <ul style="list-style-type: none"> Unroller for single sided tapes H367 0003

Refer to the product glossary for information on colours and packaging

STORAGE EQUIPMENT

Description	Article Code	Use
NAIROD PALLET (brand new)	087Q0057	For transportation and storage of mobile court (160 × 120 × 180)
NAIROD PALLET (2 nd hand)	087Q0057	

Description	Article Code	Use
SERVING TROLLEY Portable floors	088H0001	To wind and unwind Bateco or portable floors
SERVING TROLLEY Bateco	088F0001	

Description	Article Code	Use
STORAGE RACK FOR 4 ROLLS DPP4	087E0039	For BATECO storage
STORAGE RACK FOR 4 ROLLS DPP4	088N0001	For portable floors
STORAGE RACK FOR 6 ROLLS DPP6	088O0001	For BATECO storage
STORAGE RACK FOR 6 ROLLS DPP6	088K0001	For portable floors
STORAGE RACK FOR 8 ROLLS DPP8	087B0037	For BATECO storage
STORAGE RACK FOR 10 ROLLS DPP10	088J0001	For BATECO storage: Must be ordered with a frame extension pair
STATIC WALL STORAGE RACK	088E0001	

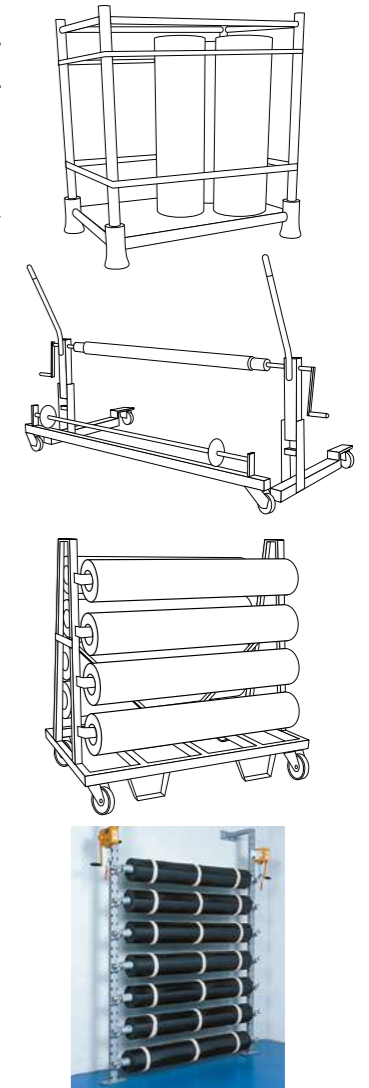

ACCESSORIES

Description	Article code	Use
MOTORIZED UNWINDING KIT	088G0001	Motorised system to easily wind and unwind Bateco or sports floors
HOLDING STRAP	H2950001	Holding strap to prevent roll unwinding Use 2 for a 1.5m roll
FRAME EXTENSION PAIR	087G0042	The frame extension pair is only to support the roll hoist. It enables the lifting of rolls to the highest position on roll stands
ROLL HOIST PAIR	H4000012	Indispensable device for easy upload or download of rolls

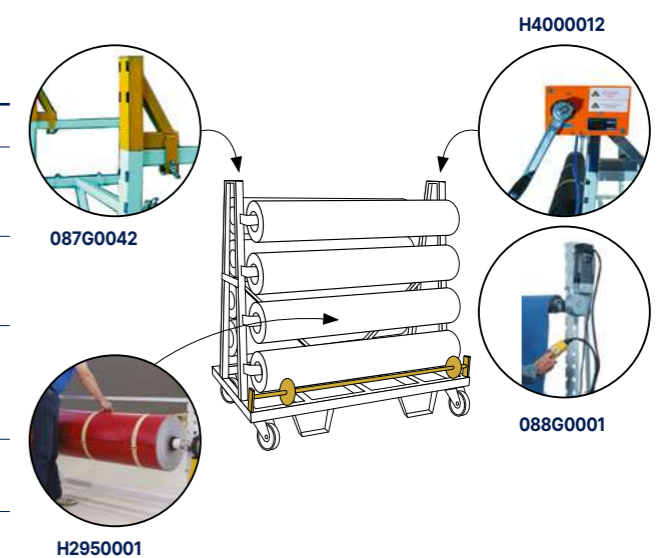



Specifications

pages 364-371

366. Gerflor specifications

Gerflor Specifications

Education - Industry - Hotel - Restaurant

	Mipolam Homogeneous		Premium		Taralay Multilayered				Technical Tiles			Creation LVT						Technical Solutions			Safety Flooring			DLW Lino		
	Compact	Compact	Acoustic	Compact	Textile backing	Acoustic	Compact	Acoustic	Compact	Compact	Acoustic	Compact	Compact	Compact	Acoustic	Compact	Acoustic	Compact	Compact	Compact	Compact	Compact	Compact	Acoustic	LCH	
Homogeneous Flooring (Evercare™)																										
Homogeneous Flooring (PUR)																										
Premium Comfort / Taralay Millennium Acoustic																										
Premium Compact / Taralay Millennium Compact																										
Taralay Libertex																										
Taralay Impression Acoustic / Taralay Impression Hop Acoustic																										
Taralay Initial Comfort																										
Taralay Impression Compact / Taralay Impression Hop Compact																										
Taralay Initial Compact																										
Tarastep Pro																										
Attraction®																										
GTI® Max / GTI® Pure																										
GTI EL5																										
Design Tile																										
R-Tile																										
Creation 55 LooseLay Acoustic																										
Creation Saga²																										
Creation Zen																										
Creation 70 Connect																										
Creation 70 MegaClic																										
Creation 70																										
Creation 55																										
Creation 40																										
Creation 30																										
EL5/EL7 solutions (Static control flooring)																										
Shower system																										
Wall covering																										
Tarasafe Ultra H2O et Tarasafe H2O																										
Tarasafe Ultra / Design (SparClean®)																										
Tarasafe Standard																										
Tarasafe Plus / Super																										
Linoleum Compact																										
Linoleum Acoustic																										
Linoleum Technical Solutions																										

EDUCATION

Reception	•			•	•																				
Corridors	•		•	•	•																				
Classroom	•		•		•	•																			
Dormitory room					•	•	•																		
Changing room																									
Bathroom - Toilets																									
Meeting - Library			•		•	•	•																		
Computer room			•		•	•																			
Laboratory	•			•																					
Student's residence					•	•	•																		
Student's refectory	•		•		•																				
Multipurpose room - Hall	•		•		•																				
Stairs																									

INDUSTRY

Clean room / Laboratory	•			•																					
Changing room	•			•																					
Computer room																									
Production	•			•																					
Stocking and Packaging areas																									
Stairs																									

HOTEL - RESTAURANT

Reception					•																				
Bedroom					•		•																		
Bathroom - Toilets																									
Restaurant - Bar					•																				
Conference - Exhibition	•				•																				
Cinema - Show - Theatre					•																				
Stairs																									

• GERFLOR's recommendation □ Other possible solutions

Gerflor Specifications

Retail - Housing - Kitchen



Mipolam Homogeneous		Premium		Taralay Multilayered				Technical Tiles				Creation LVT						Technical Solutions			Safety Flooring			DLW Lino								
Compact	Compact	Acoustic	Compact	Textile backing	Acoustic	Compact	Acoustic	Compact	Compact	Acoustic	Compact	Compact	Acoustic	Compact	Compact	Compact	Acoustic	Compact	Compact	Compact	Compact	Compact	Compact	Acoustic	LCH							
Homogeneous Flooring (Evercare™)	Homogeneous Flooring (PUR)	Premium Comfort / Taralay Millennium Acoustic	Premium Compact / Taralay Millennium Compact	Taralay Libertex	Taralay Impression Acoustic / Taralay Impression Hop Acoustic	Taralay Initial Comfort	Taralay Impression Compact / Taralay Impression Hop Compact	Taralay Initial Compact	Tarastep Pro	Attraction®	GTI® Max / GTI® Pure	GTI EL5	Design Tile	Creation 55 LooseLay Acoustic	Creation Saga²	Creation Zen	Creation 70 Connect	Creation 70 MegaClic	Creation 70	Creation 55	Creation 40	Creation 30	EL5/EL7 solutions (Static control flooring)	Shower system	Wall covering	Tarasafe Ultra H2O et Tarasafe H2O	Tarasafe Ultra / Design (SparClean®)	Tarasafe Standard	Tarasafe Plus / Super	Linoeum Compact	Linoeum Acoustic	Linoeum Technical Solutions

RETAIL

Shop	•		•							•			•			•	•	•	•													
Department store			•							•			•				•	•	•													
Supermarket			•							•	•		•				•															
Cafeterias			•	•		•							•			•	•	•	•													
Stocking areas											•																					
Stairs									•																							

HOUSING

Dry Private room				•		•								•		•			•	•	•												
Damp Private room						•																	•			•	•	•					
Reception area - Corridor - Landing				•		•				•			•			•	•	•								•							
Other private home																							•										

KITCHEN

Collective kitchens																																			
Food preparation areas - Canteen																																			

- GERFLOR's recommendation
- Other possible solutions

Installation & Maintenance instructions on gerflor.com

Notes

Gerflor web site

New design,
New navigation!

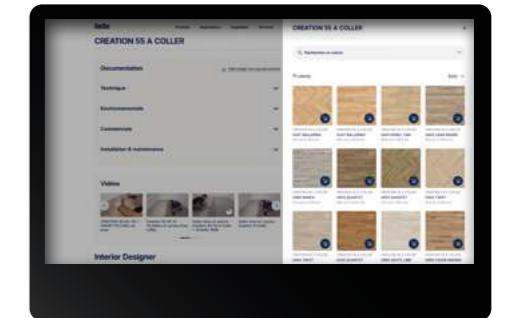
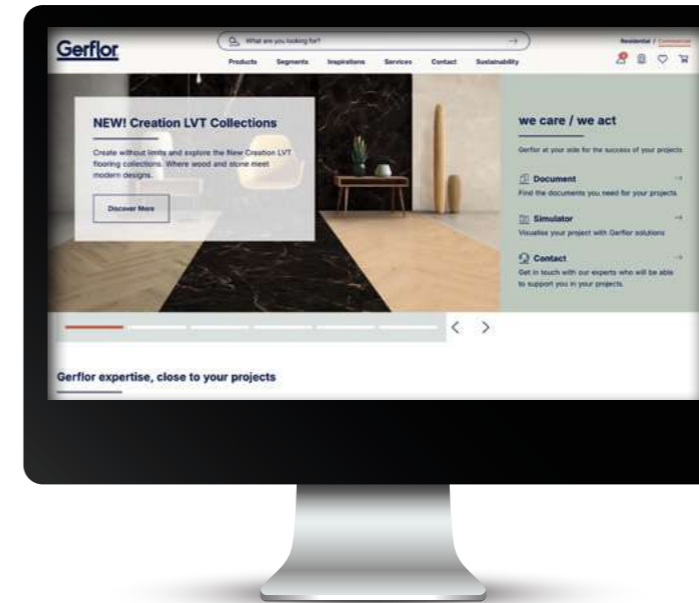

1 Virtual library
Access to all commercial and technical documentation that will help you developing your projects.

A website you can access on your tablet or smartphone everywhere!

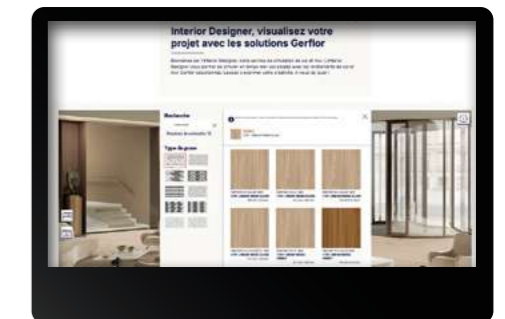

2 Interior designer
The Interior Designer provide you a real time simulation of the floor selected either in your own photo or in a pictures' gallery.



Follow us on social media!

Gerflor Be connected!





#Gerflor



3 Store locator
Access to our distributor partners list and select the closest one.



We care / we act our commitments for 2030

 <p>climate</p> <p>-30% CO₂ scopes 1, 2, 3 in tons eq. CO₂, vs 2019 Science Based Targets⁽¹⁾</p>	 <p>resources</p> <p>75% biobased, mineral and recycled content⁽²⁾</p> <p>30% recycled content⁽³⁾</p>	 <p>circularity</p> <p>65 000 tons annual volume recycled⁽⁴⁾</p> <p>45% loose lay⁽⁵⁾</p>	 <p>health & well-being</p> <p>100% products better than Indoor Air Quality standards⁽⁶⁾</p> <p>95% sales covered by EPD⁽⁷⁾</p>	 <p>people</p> <p>30% women⁽⁸⁾</p> <p>40% internal mobility⁽⁹⁾</p> <p>Towards 0 accident⁽¹⁰⁾</p>
--	---	--	---	--

More details: 1. Scopes 1, 2 & 3, in absolute value, market-based. Trajectory approved by SBTi (Science Based Targets Initiative). 2. Origin of raw materials for the entire Floor & Wall portfolio, on average, by weight; including 15% virgin salt, a primary element in vinyl manufacturing. Compared to 71% in 2024. 3. Average content in the Floor & Wall vinyl portfolio, by weight. Compared to 21% in 2024. 4. Recycled in our factories and recycling units. Compared to 59 040 tons in 2024. 5. % of Floor activity with non-glued products, easy to remove, easy to re-use. Compared to 40% in 2024. 6. 100% of vinyl and linoleum sold to the building market below 100 micrograms /m² (TVOC 28 days). 7. % of Floor & Wall activity covered by Environmental Product Declarations (EPD). Compared to 44% in 2024. 8. % women in our global workforce and among our managers. Compared to respectively 26% and 27% in 2024. 9. % job openings filled with internal hires worldwide. Compared to 25% in 2024. 10. Towards 0 accident: Lost time accident per million hours worked: below 3 vs 8,9 in 2024, for Gerflor employees worldwide.

